

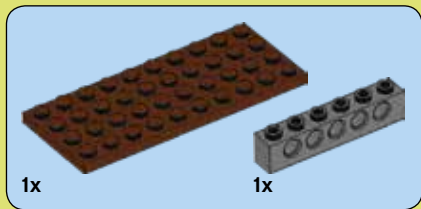

SCOOBY-DOO!

75904

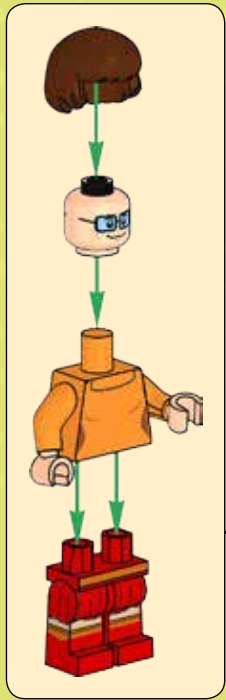

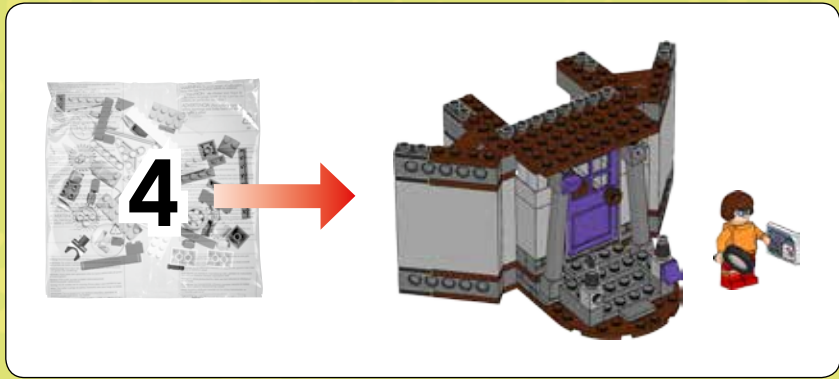

1

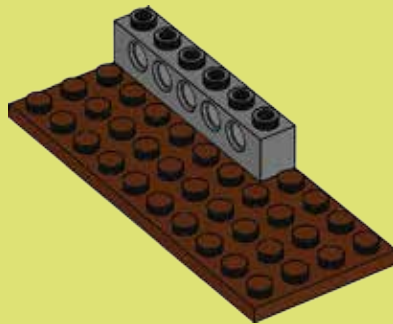

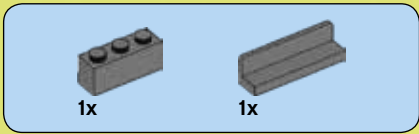

2

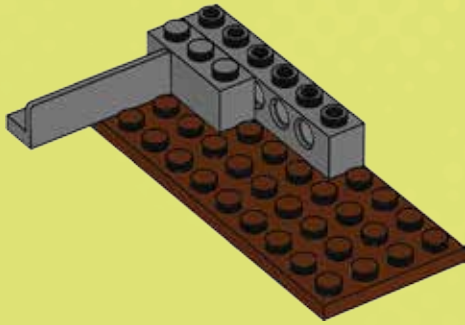

3

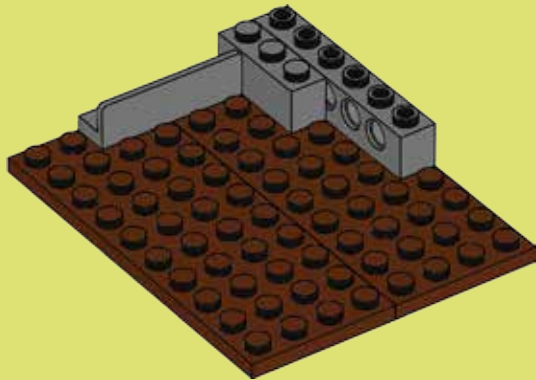

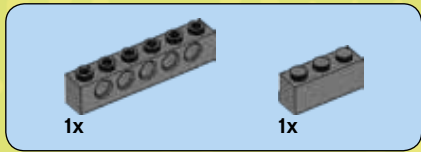

4

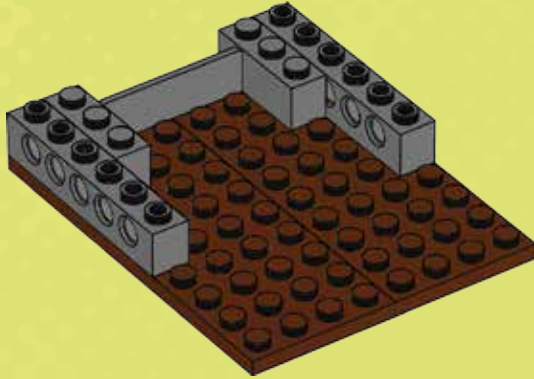

5

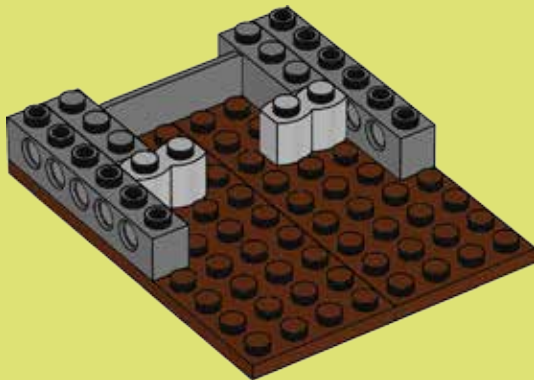

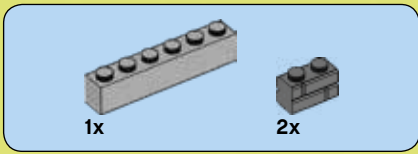

6

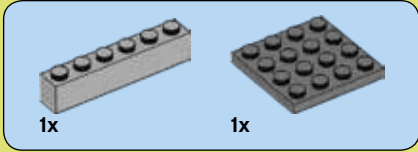
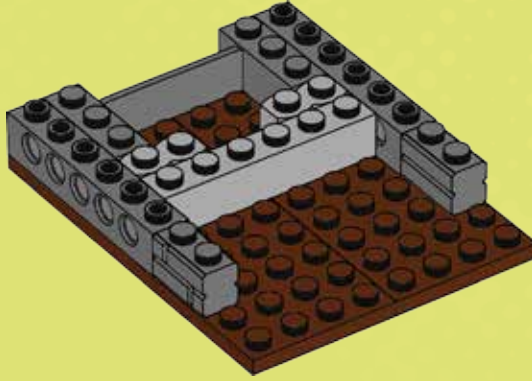

7

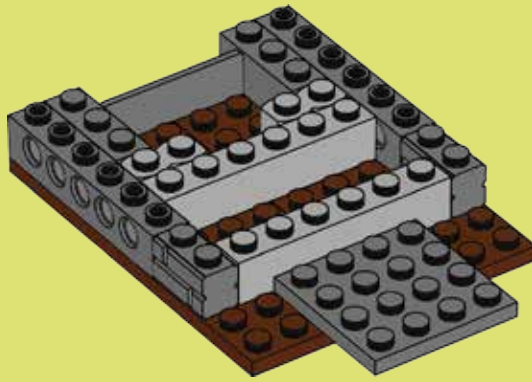



2x

8

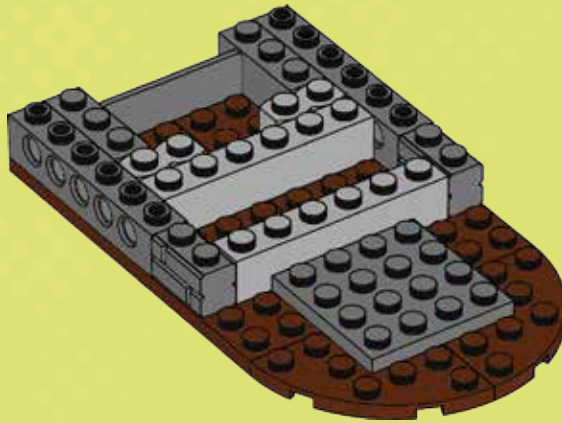

2x



1x



2x

9

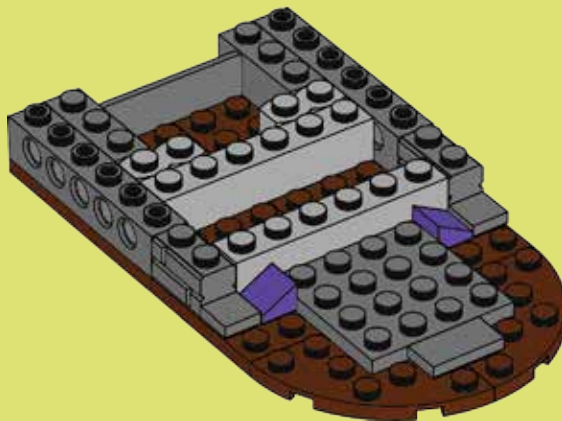

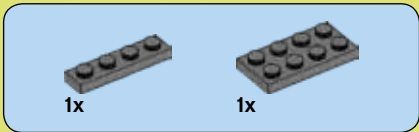

10

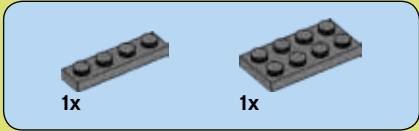
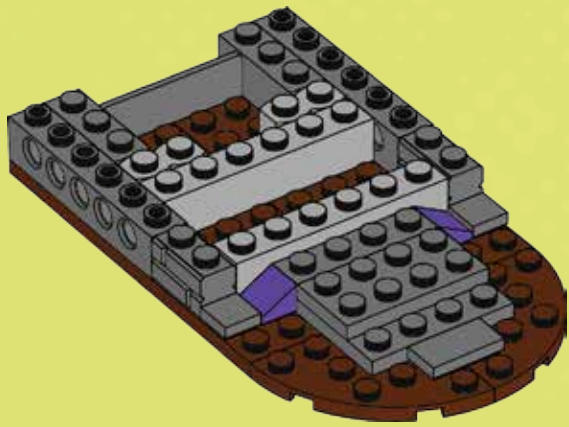

11

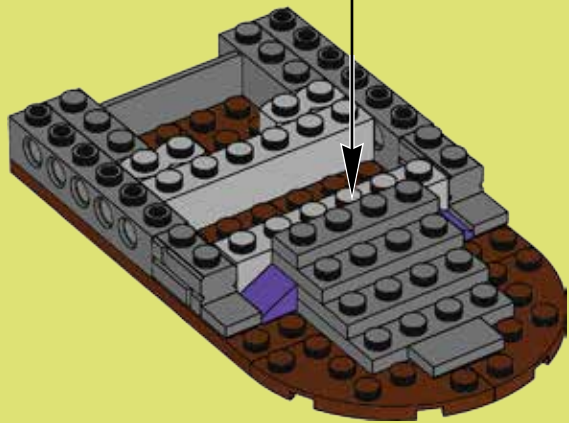
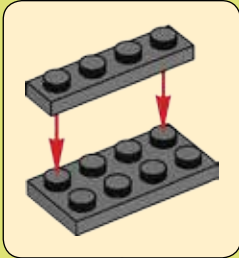



2x

12

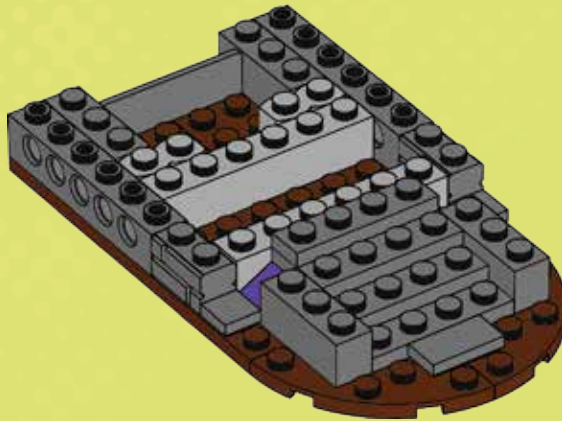

4x

13

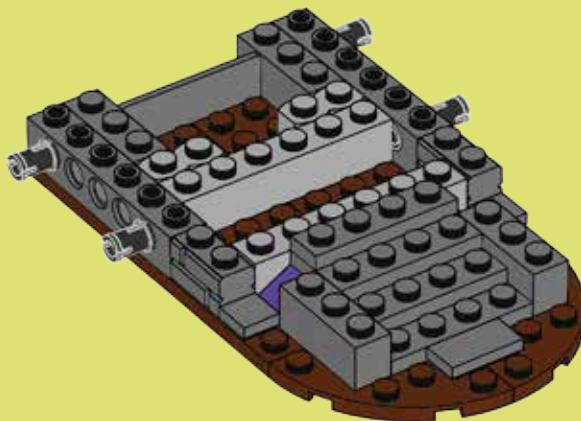

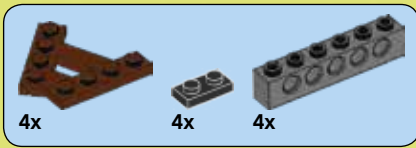

14

1 

2 

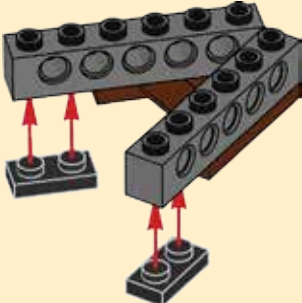
3 

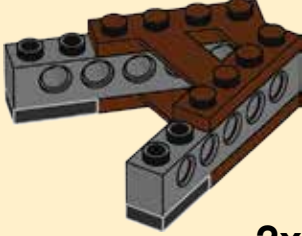
4 

2x

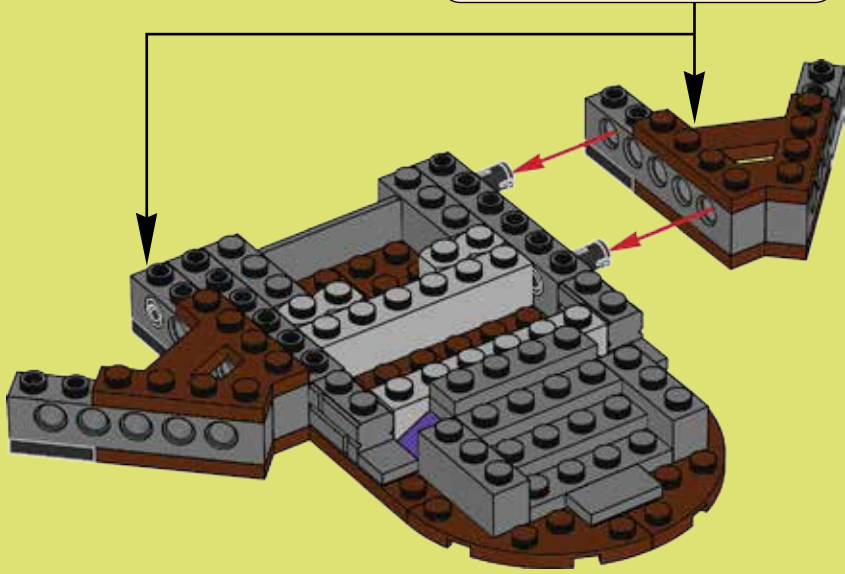

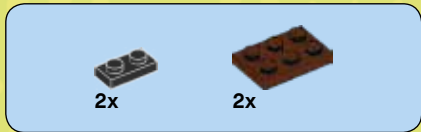

15

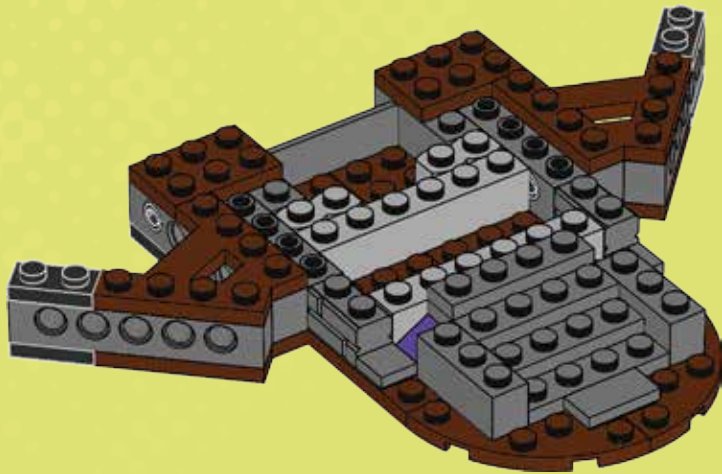

16





17

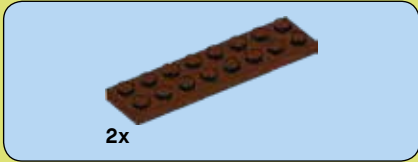
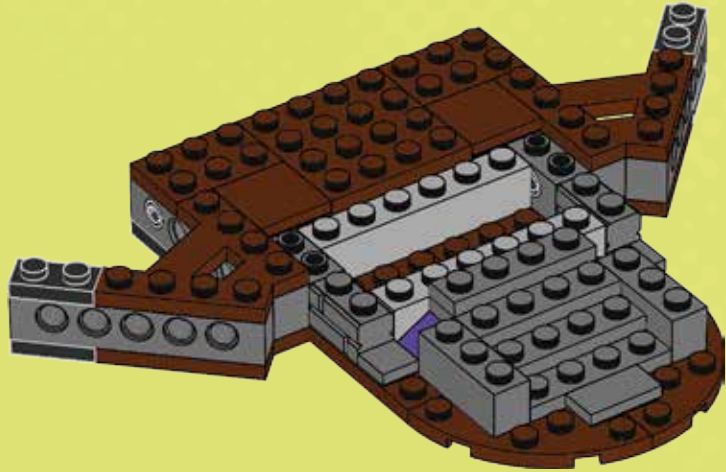

18





4x

19

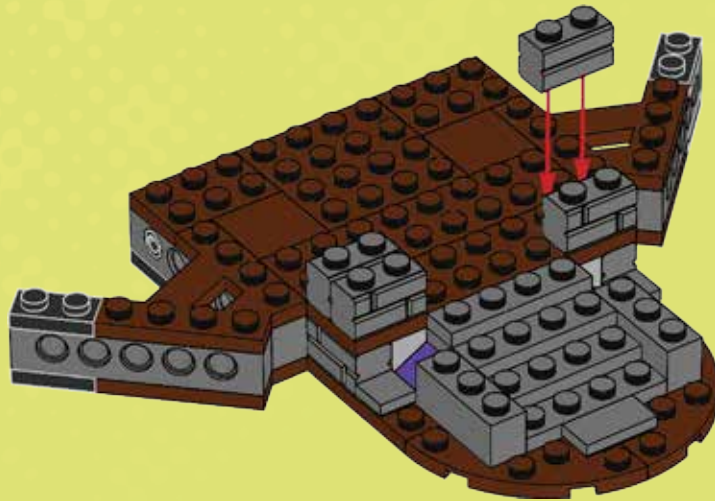

2x

20





2x



2x

21

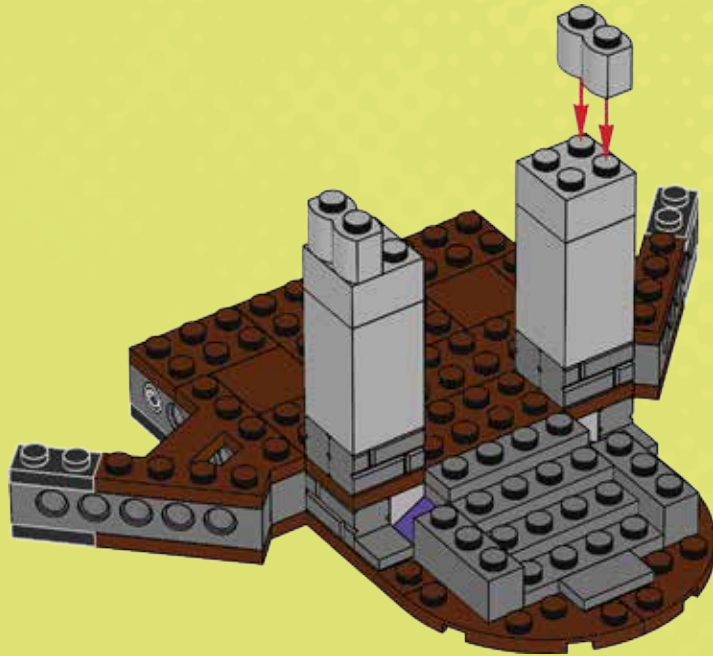

2x



2x

22

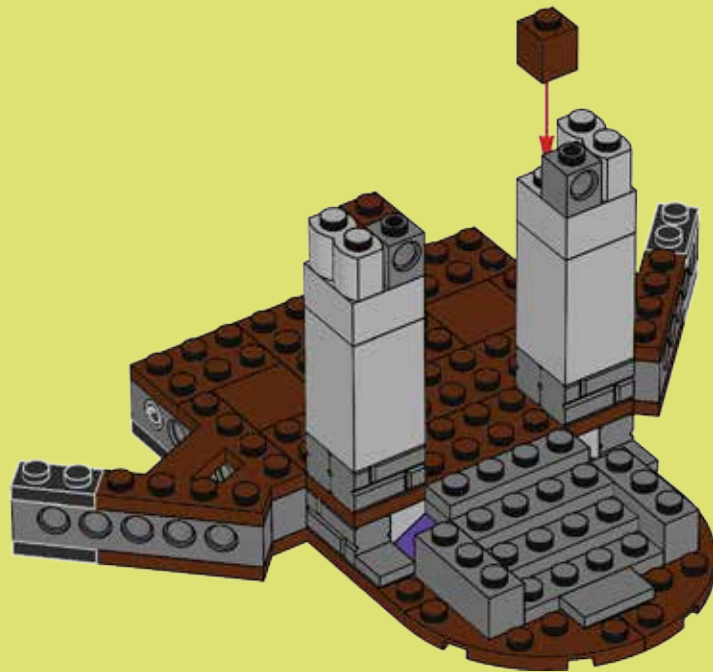

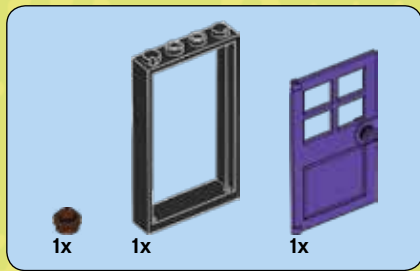

23

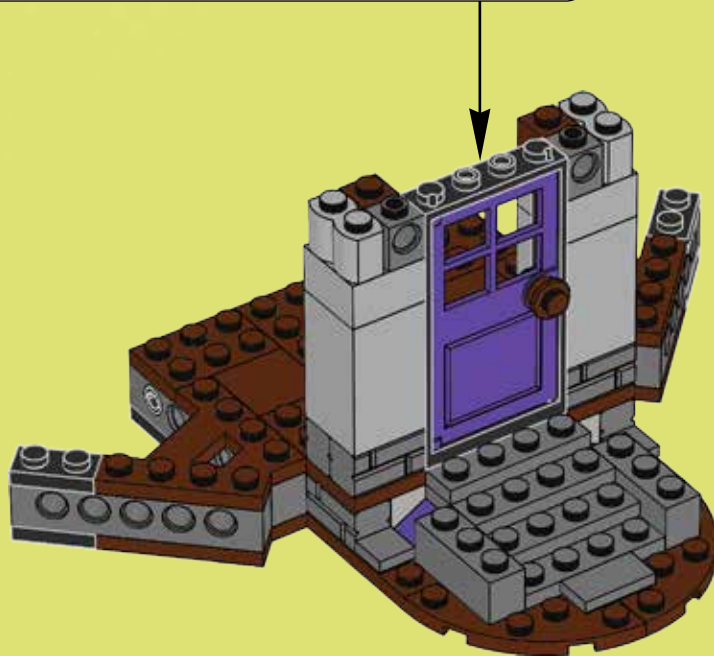
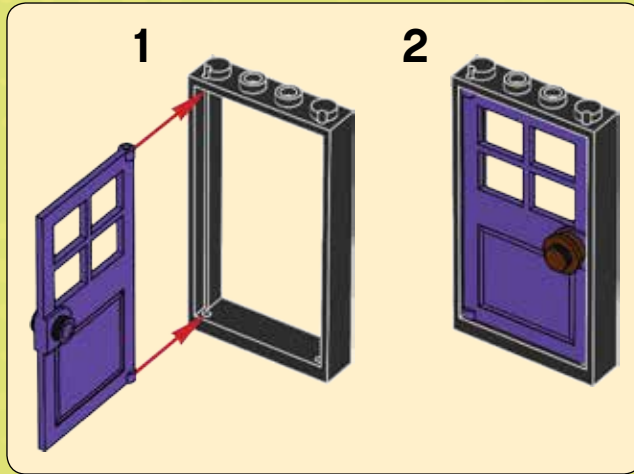

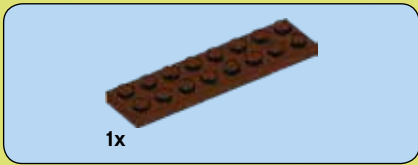

24



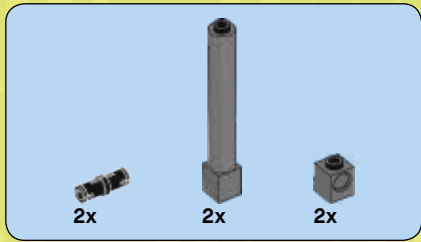

25

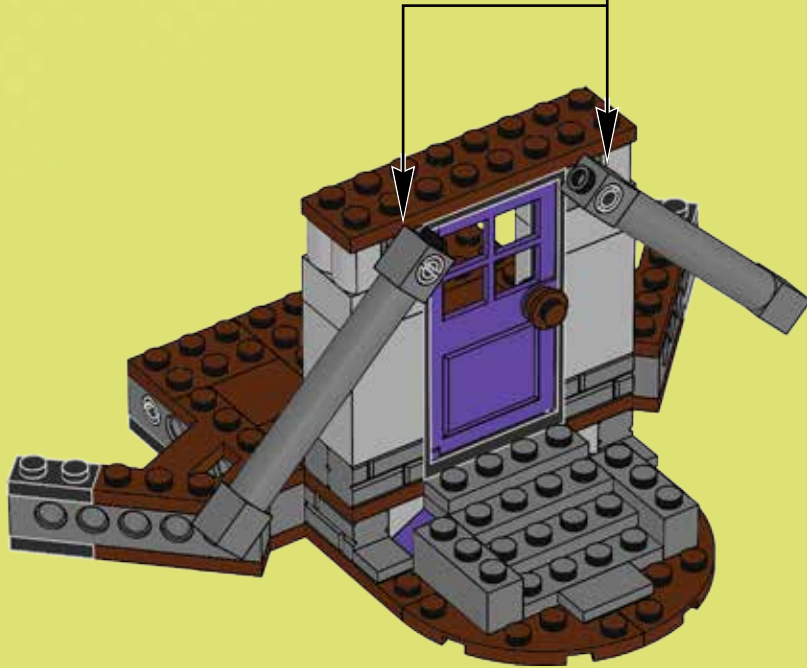
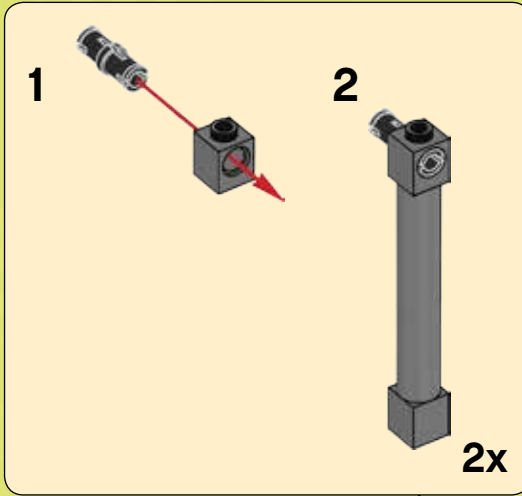

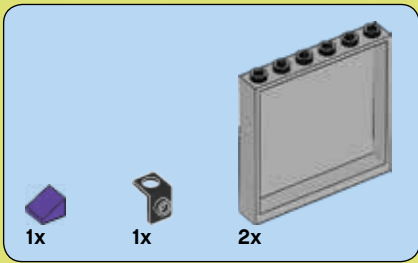

26

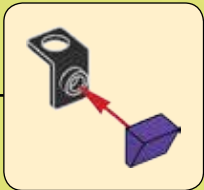
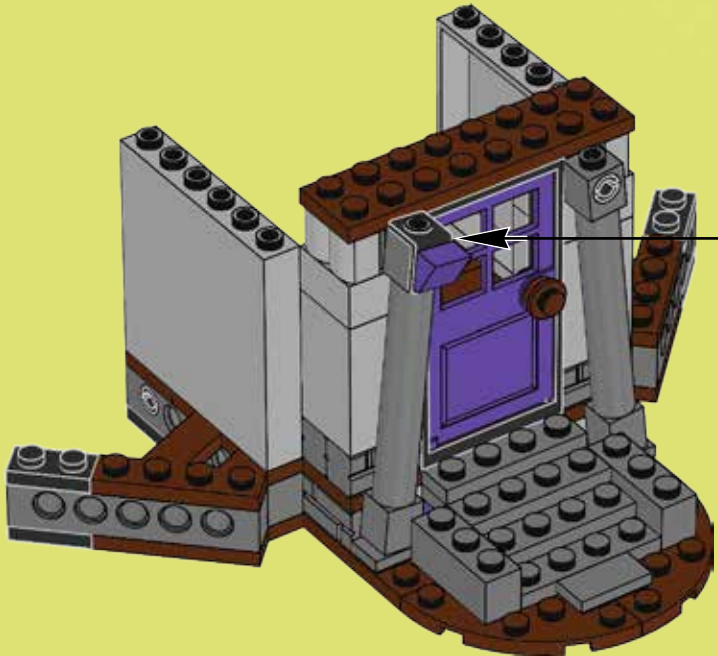

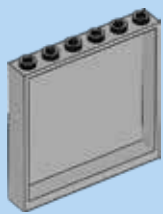

2x

27

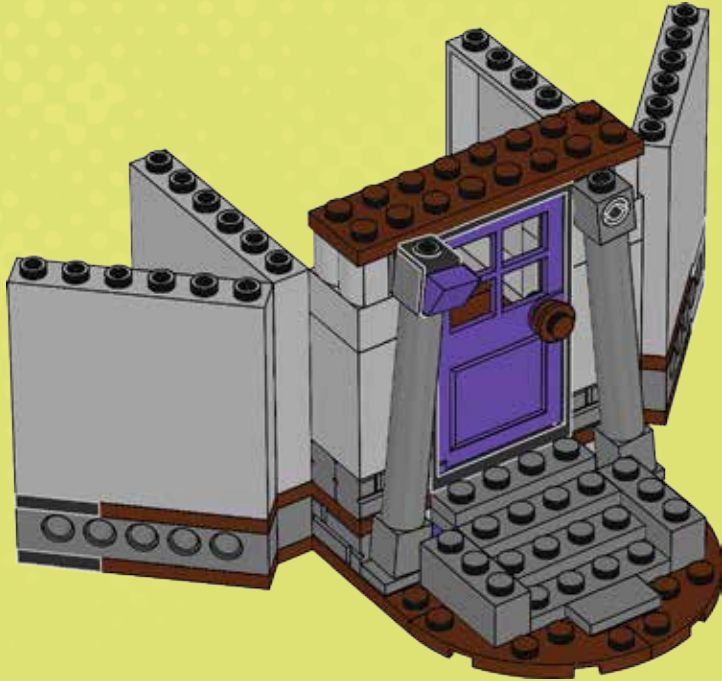

2x

28

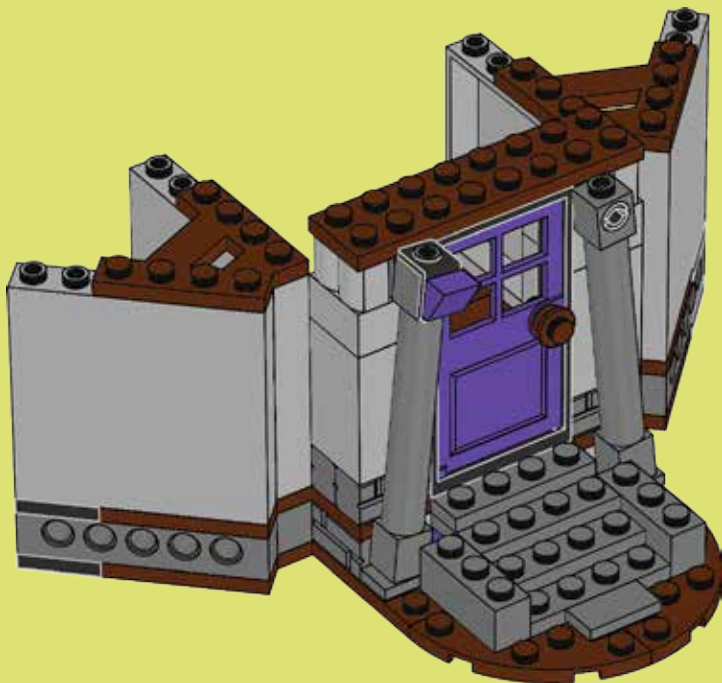



4x

29

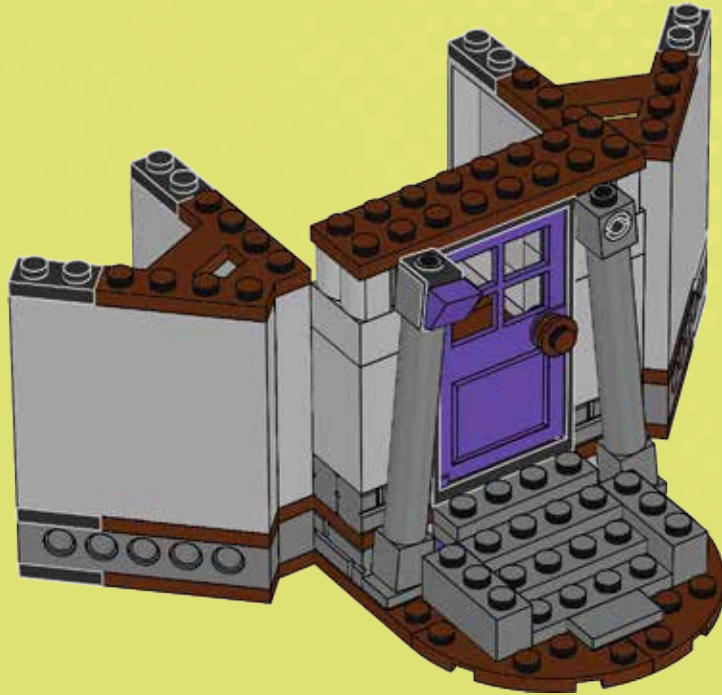

2x

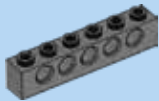

2x

30

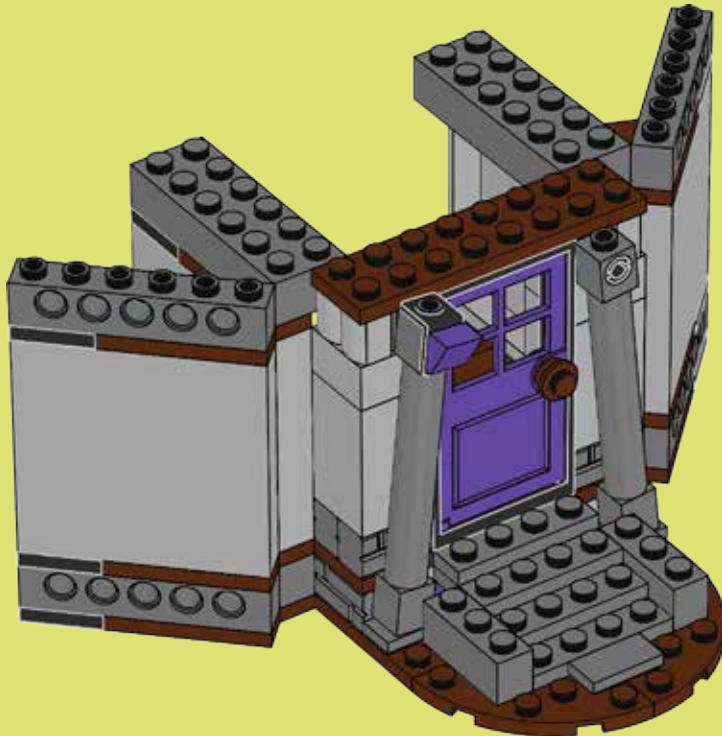



2x

31

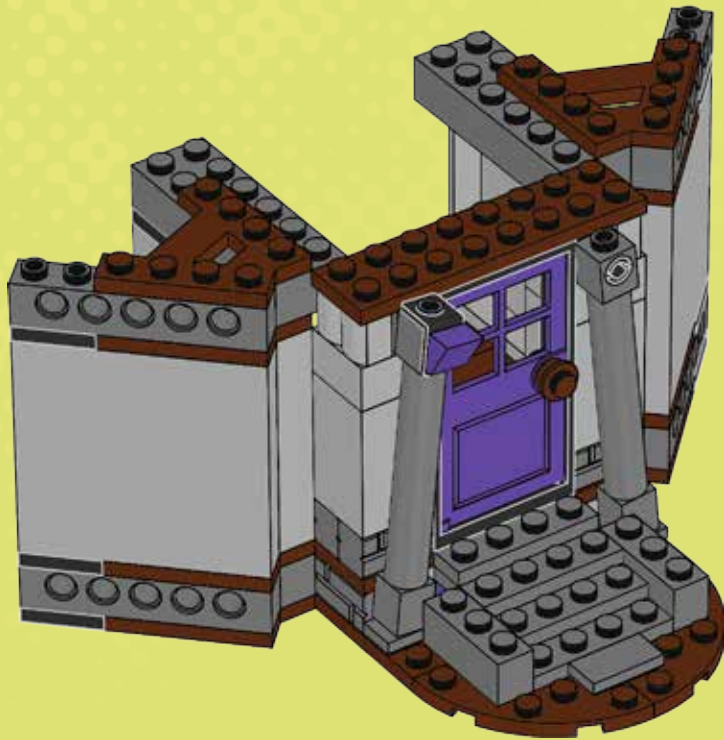

4x

32

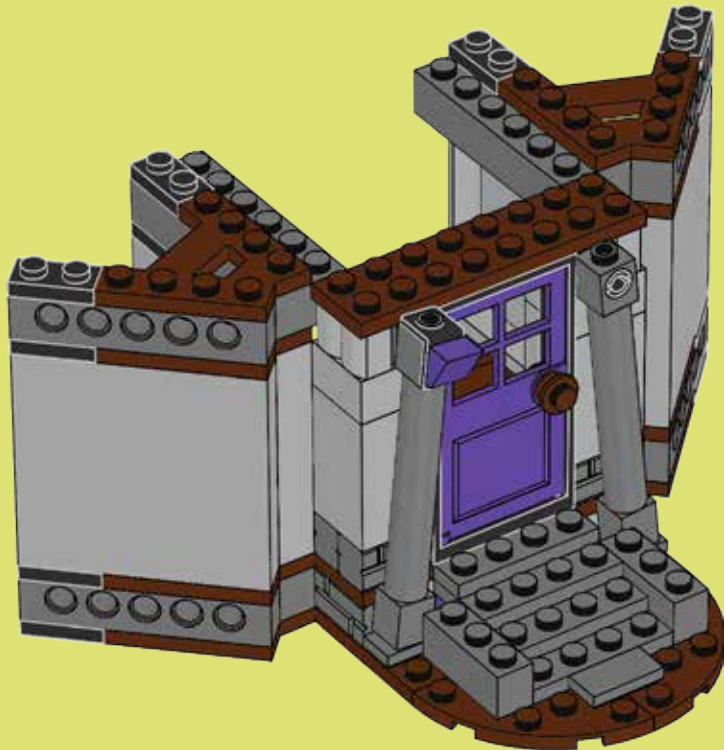

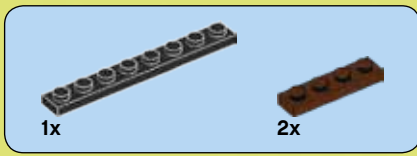

33

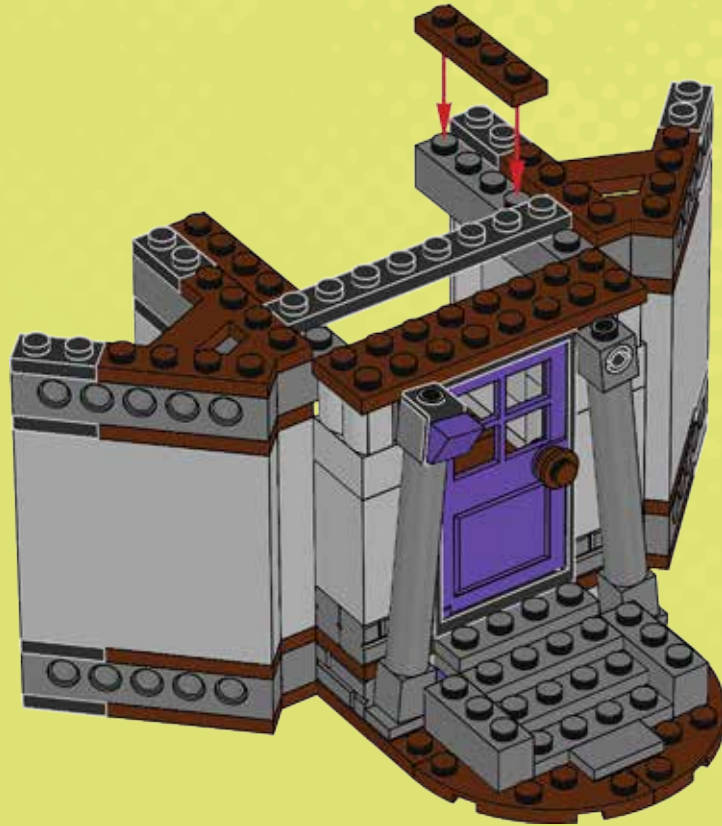

34

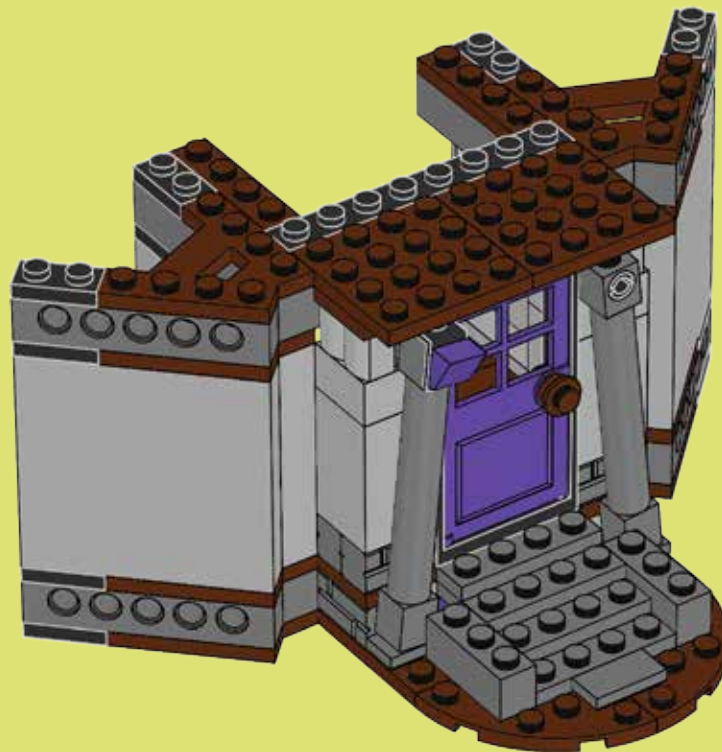

-  1x
-  1x
-  1x

35

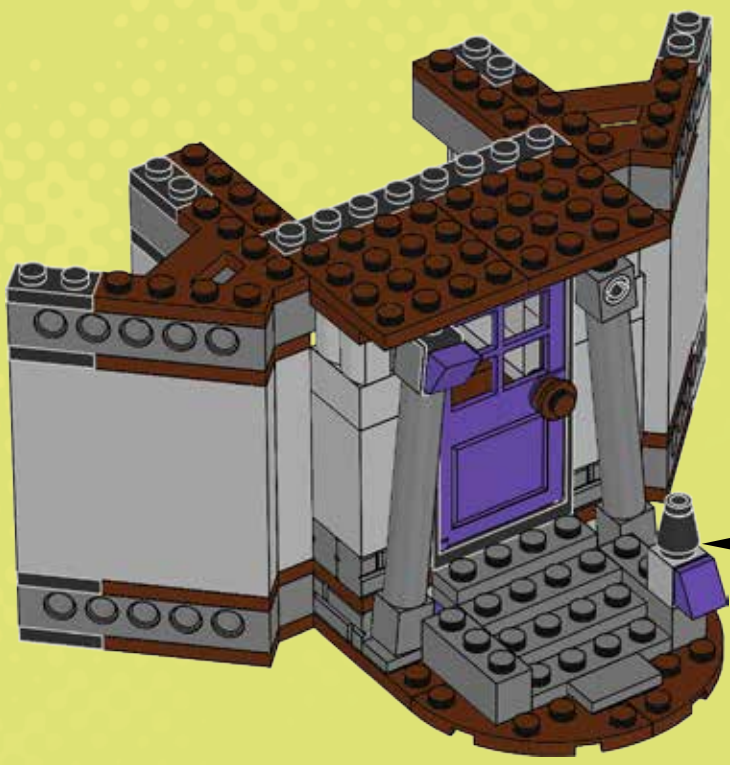

1



2



-  1x
-  1x
-  1x

36

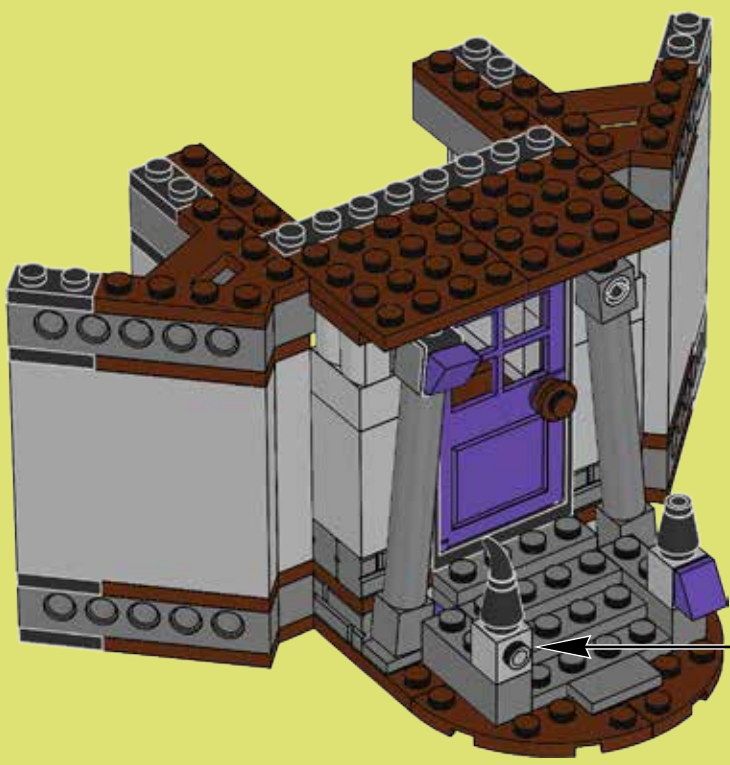

1



2



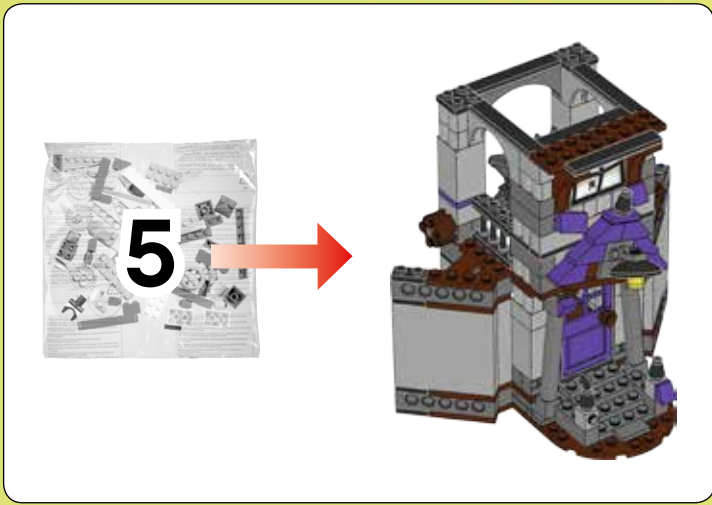

37

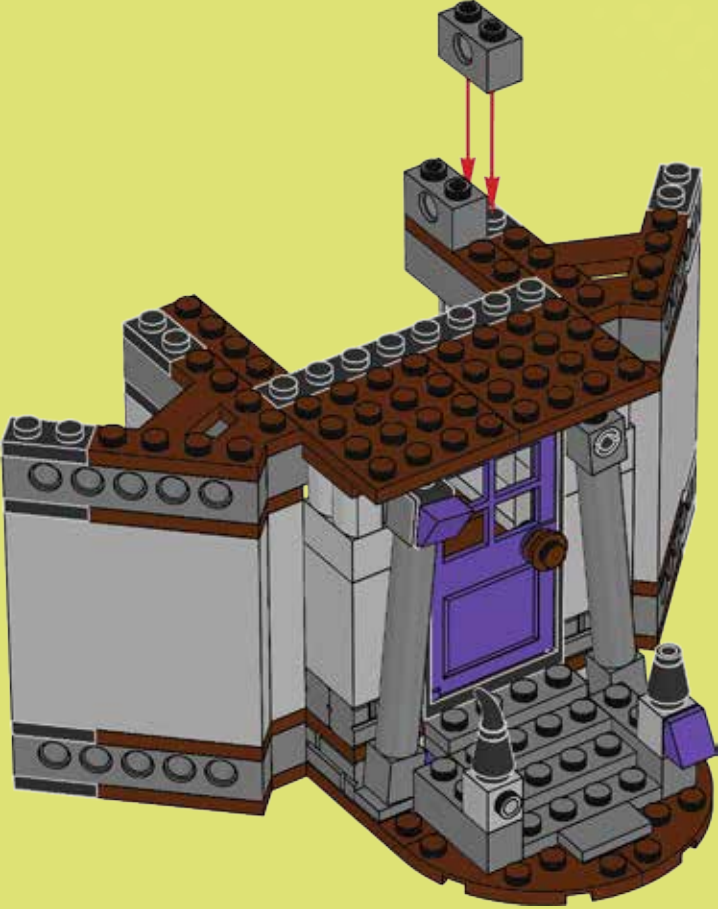

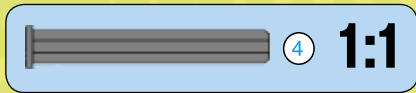

38

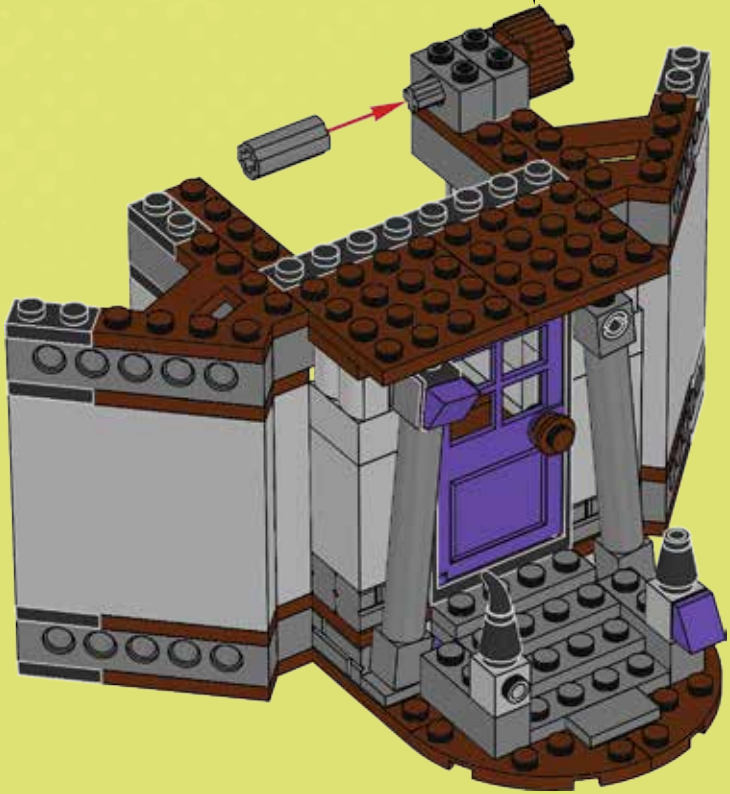
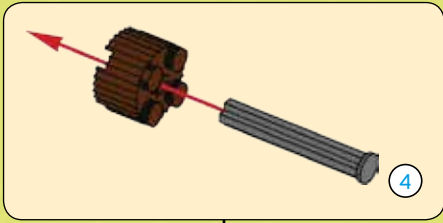

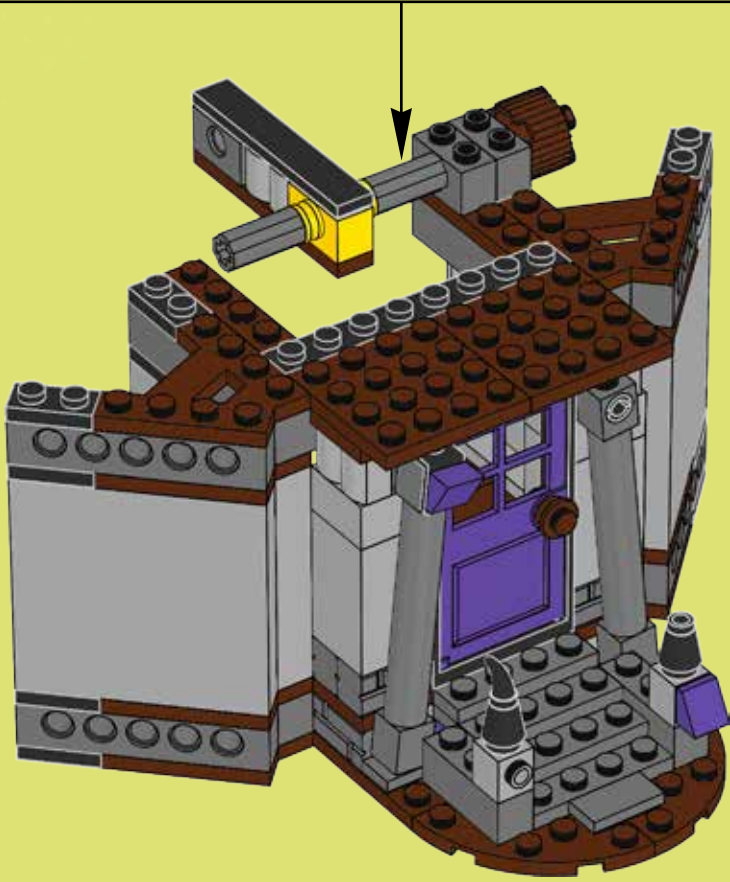
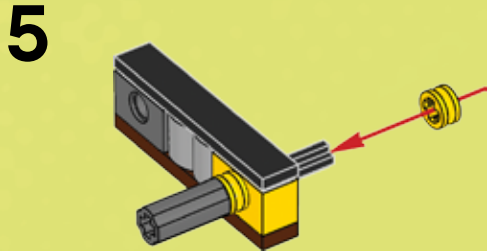
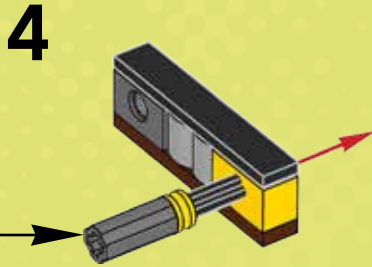
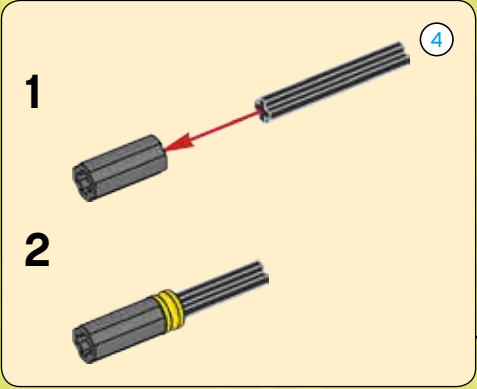



2x

40

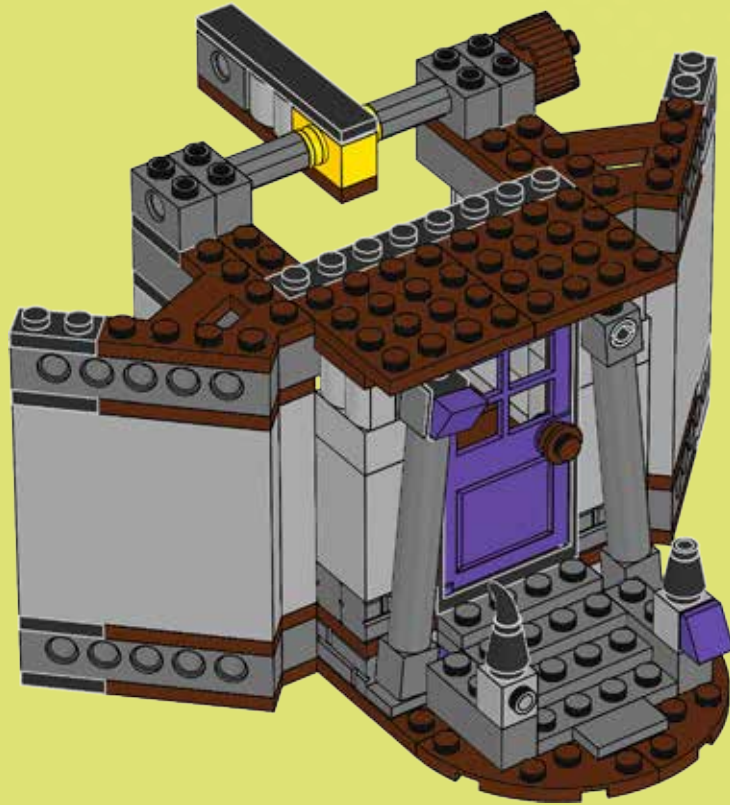

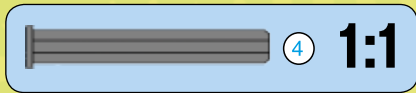
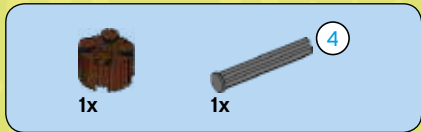

41

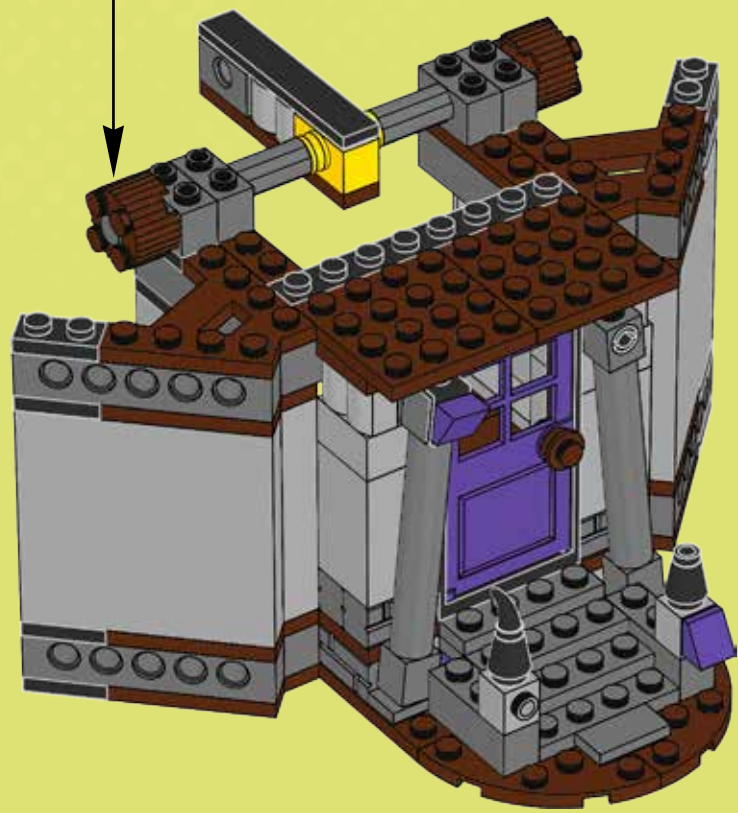
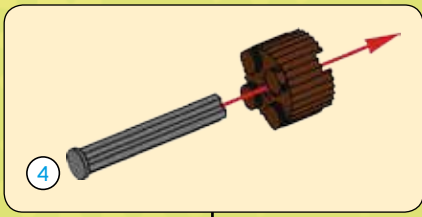

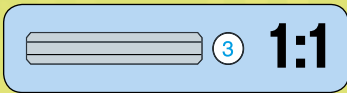
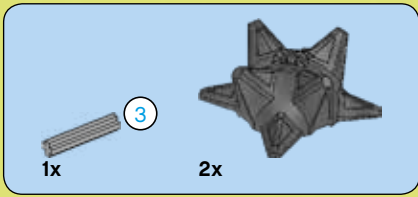

42

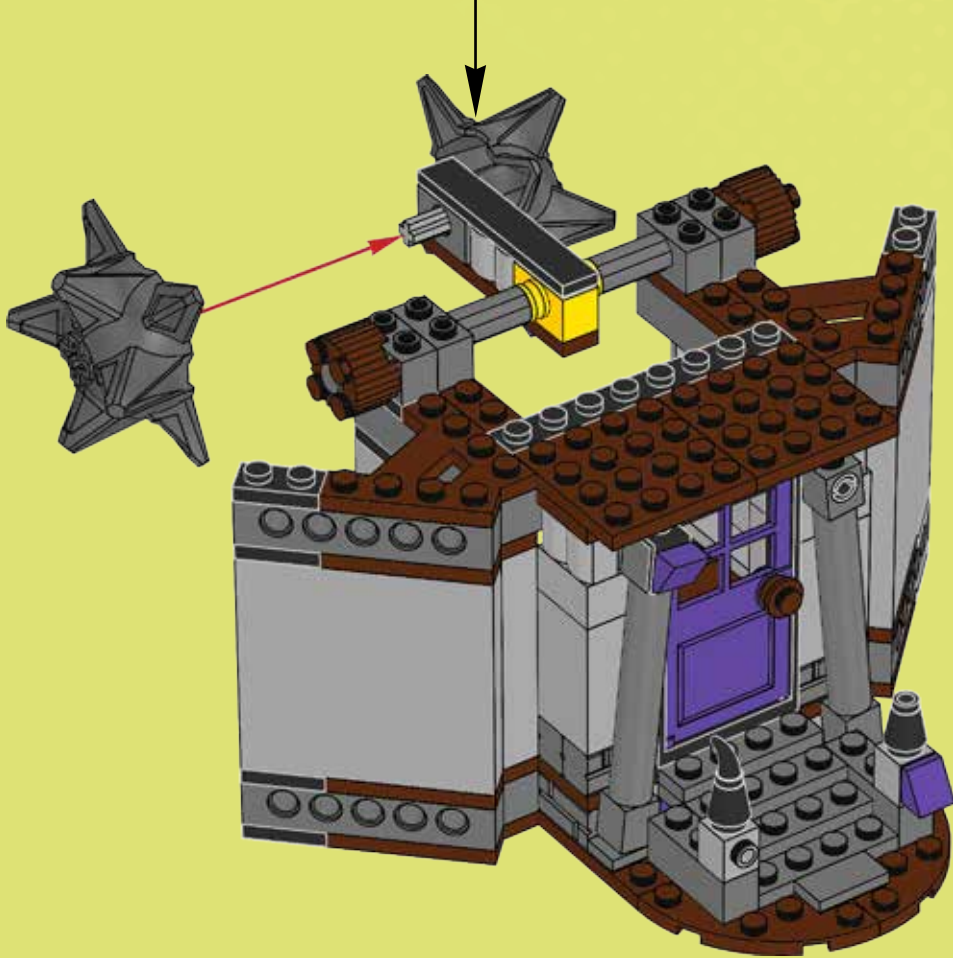
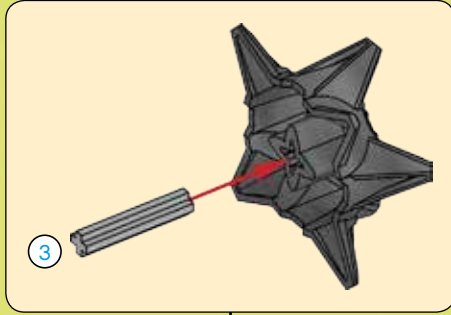

43

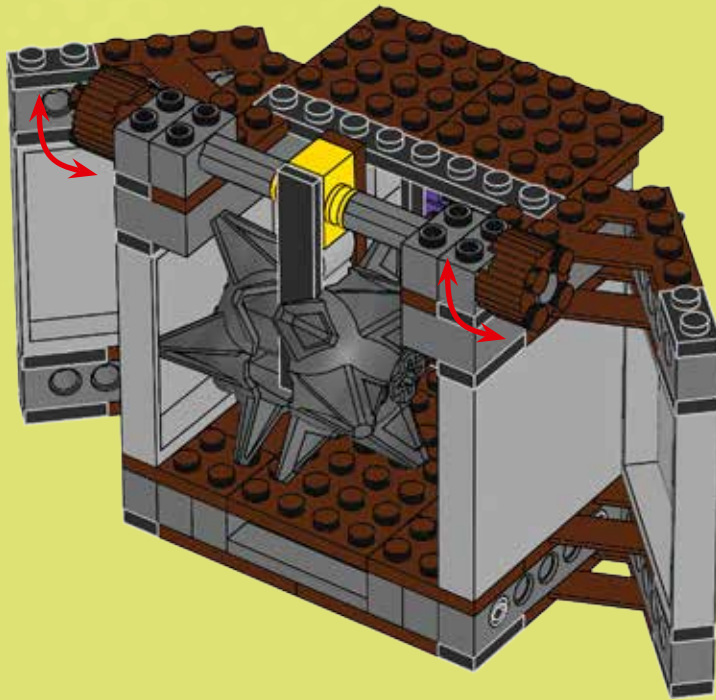

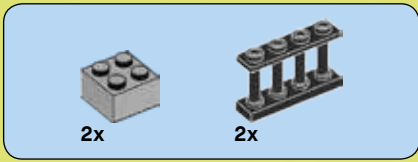

44

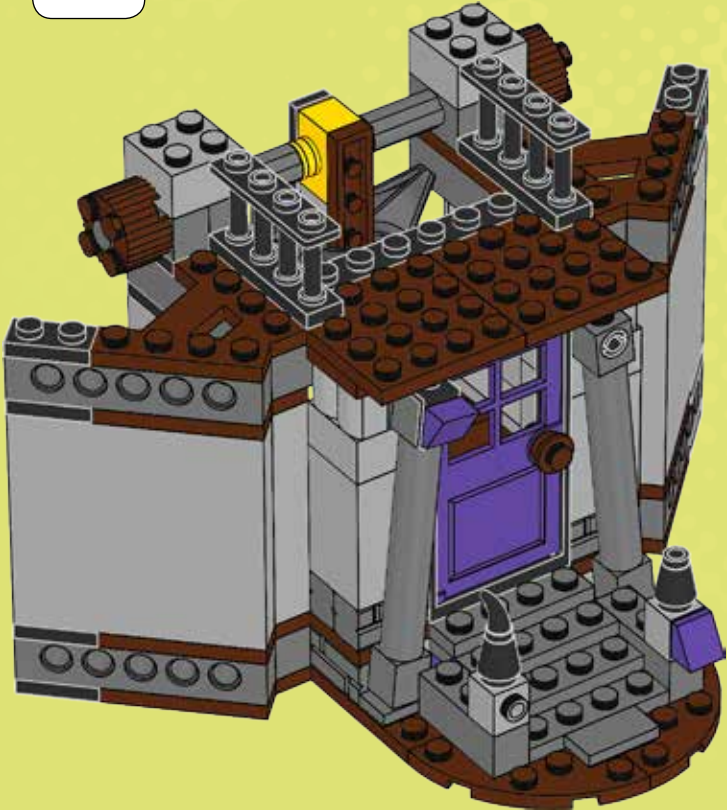

45

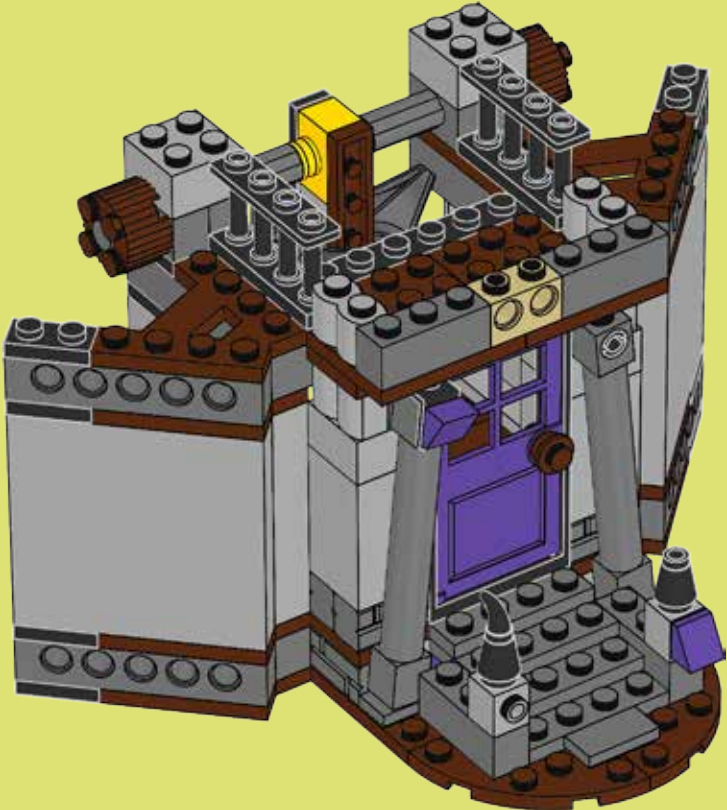

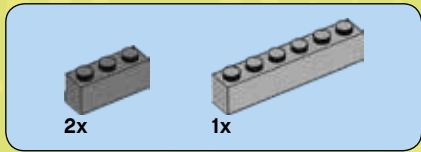

46

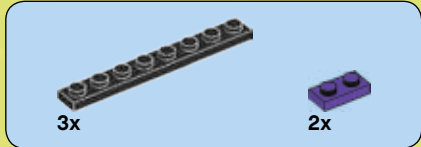
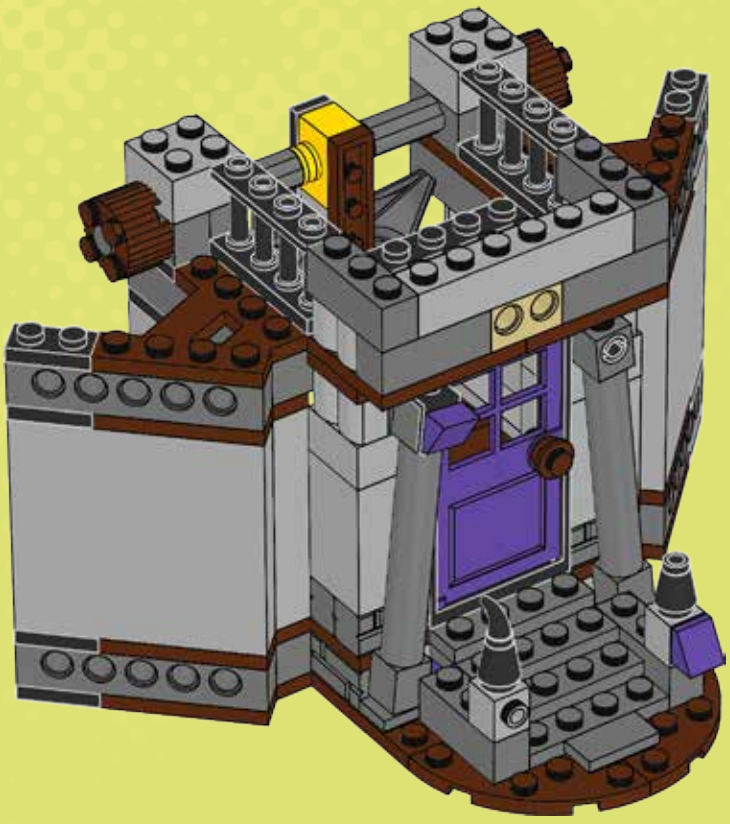

47

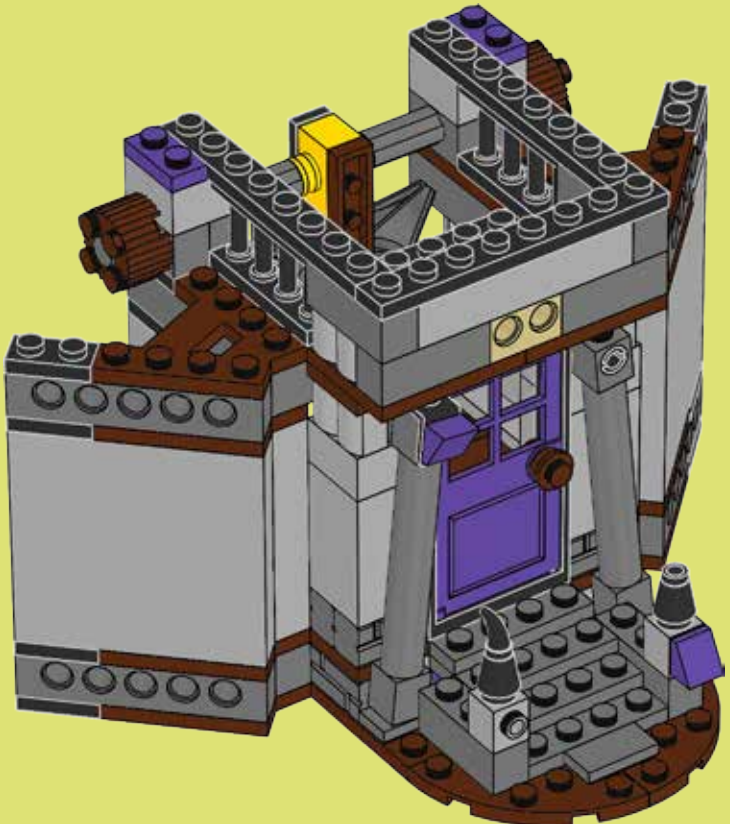

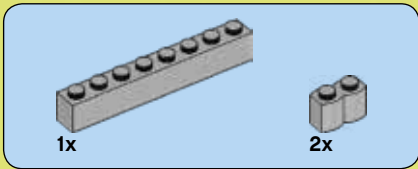

48

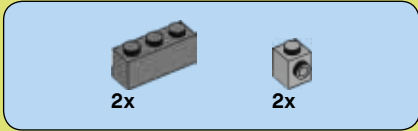
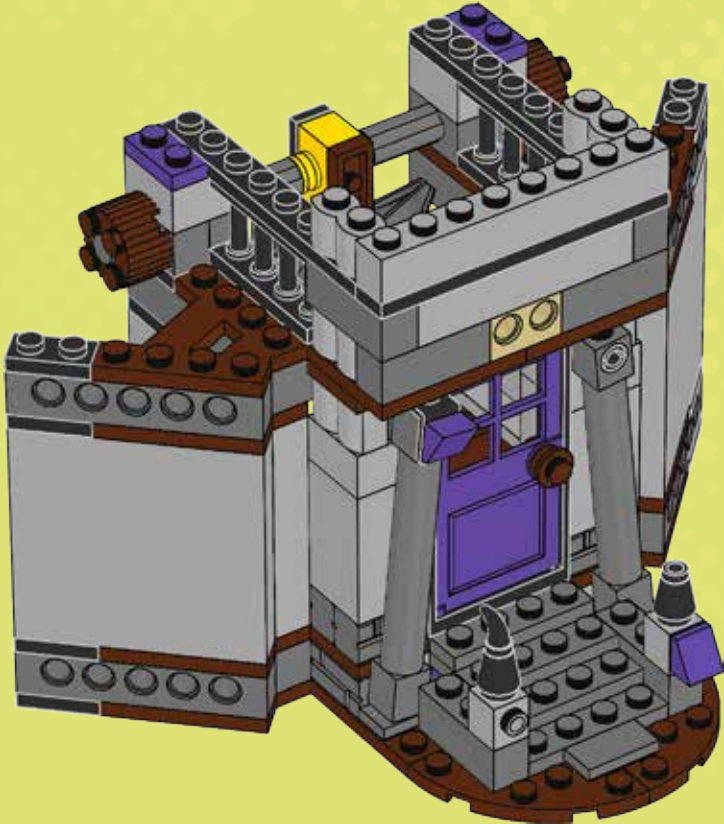

49

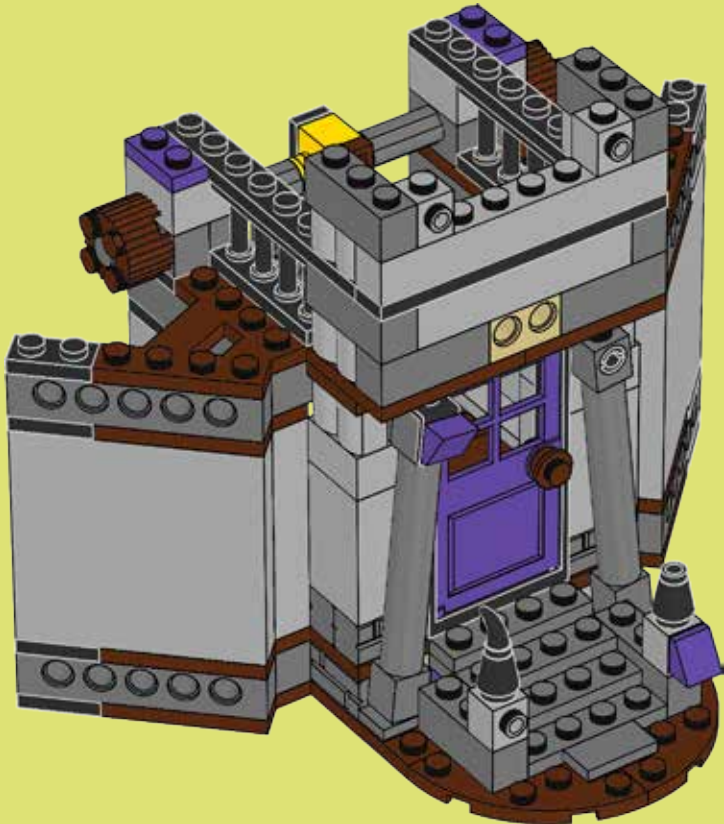



1x



2x

50

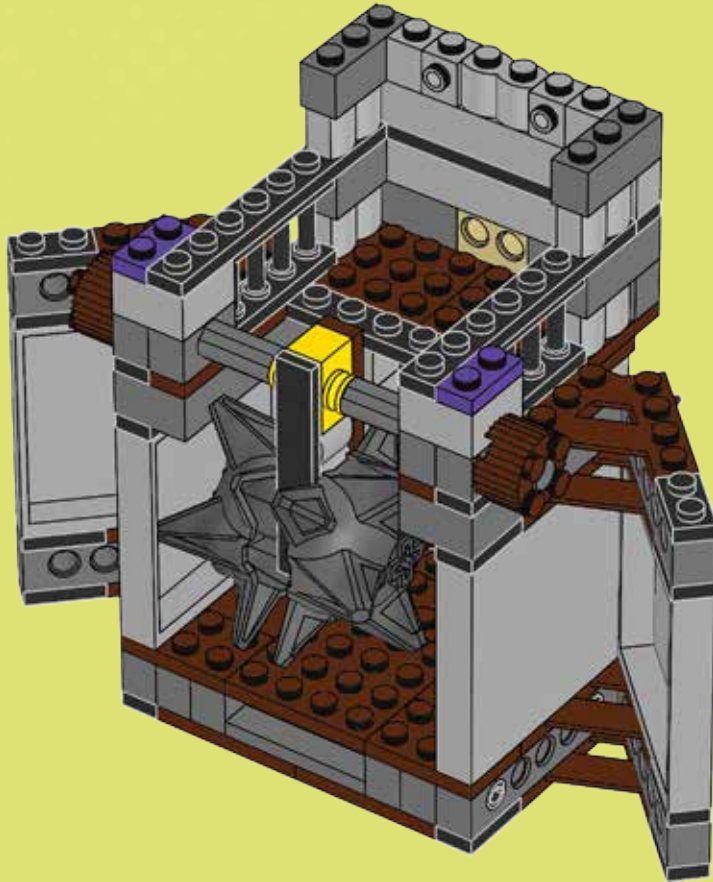

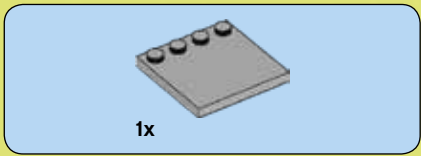

51

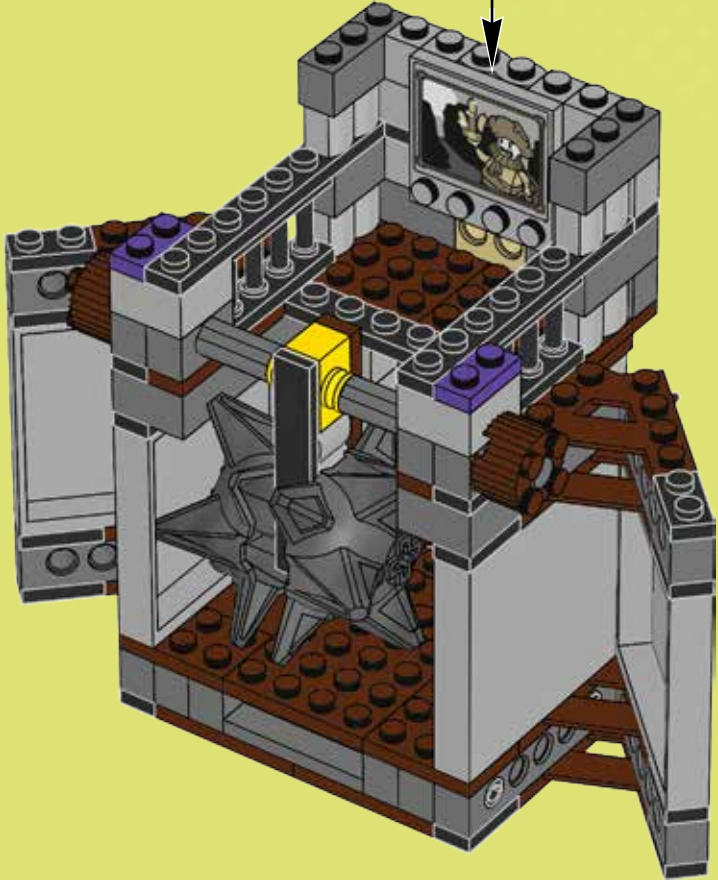
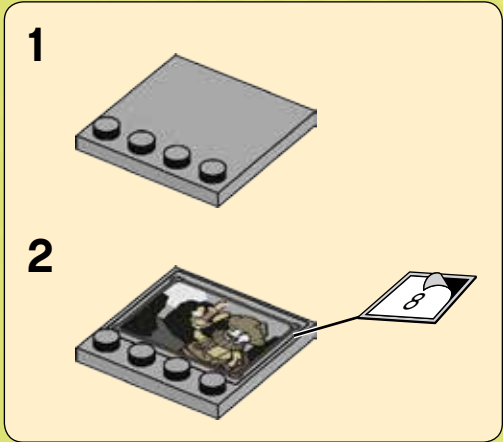

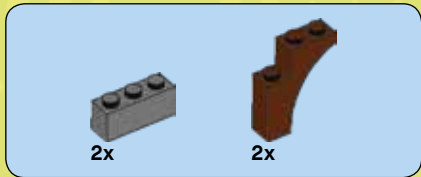

52

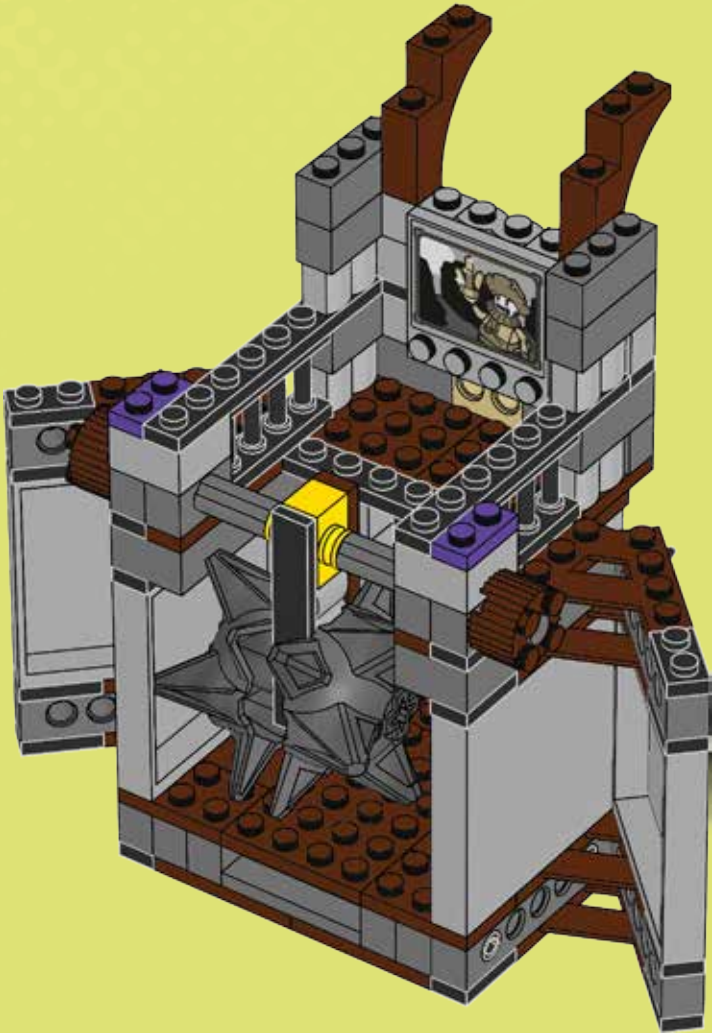

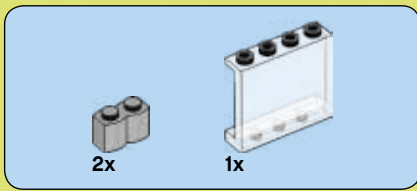

53

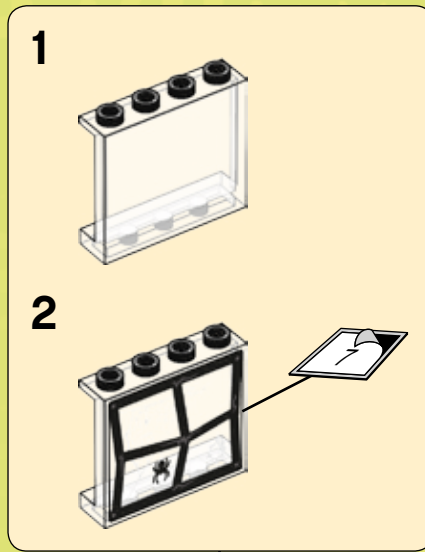

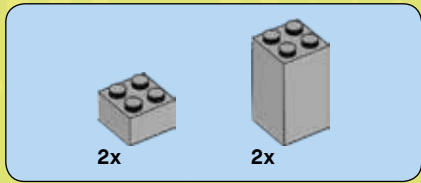

54



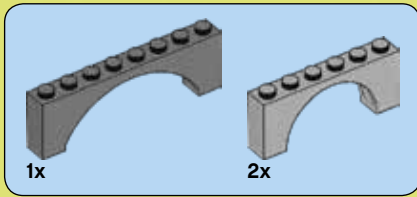

55

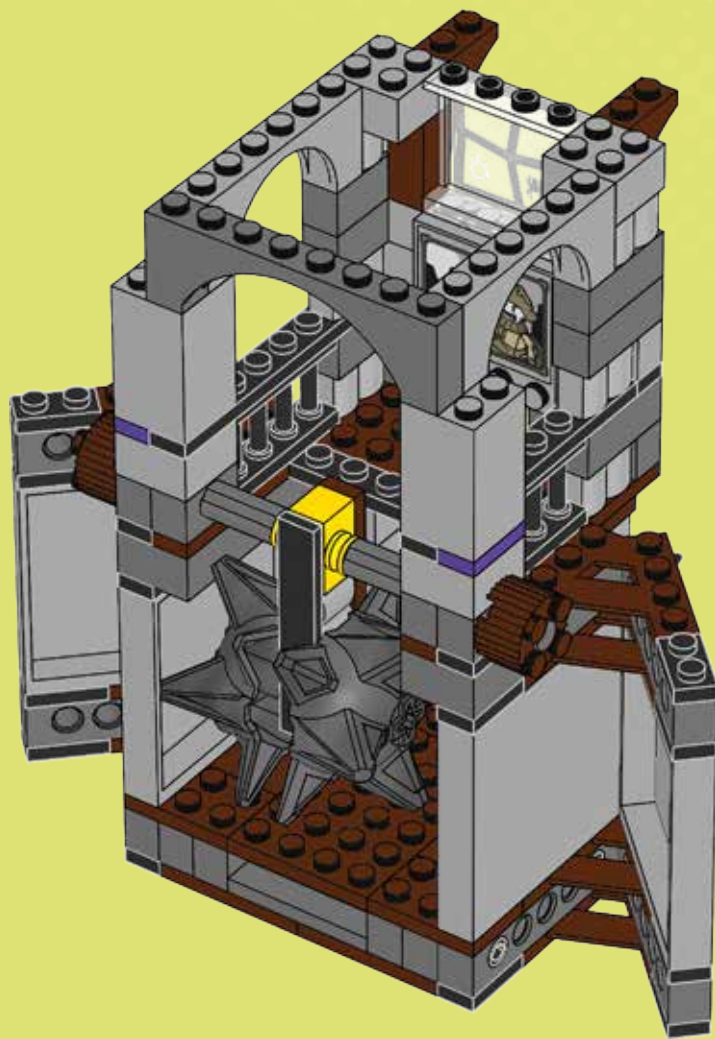



4x

56

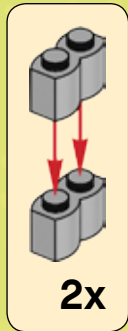

2x

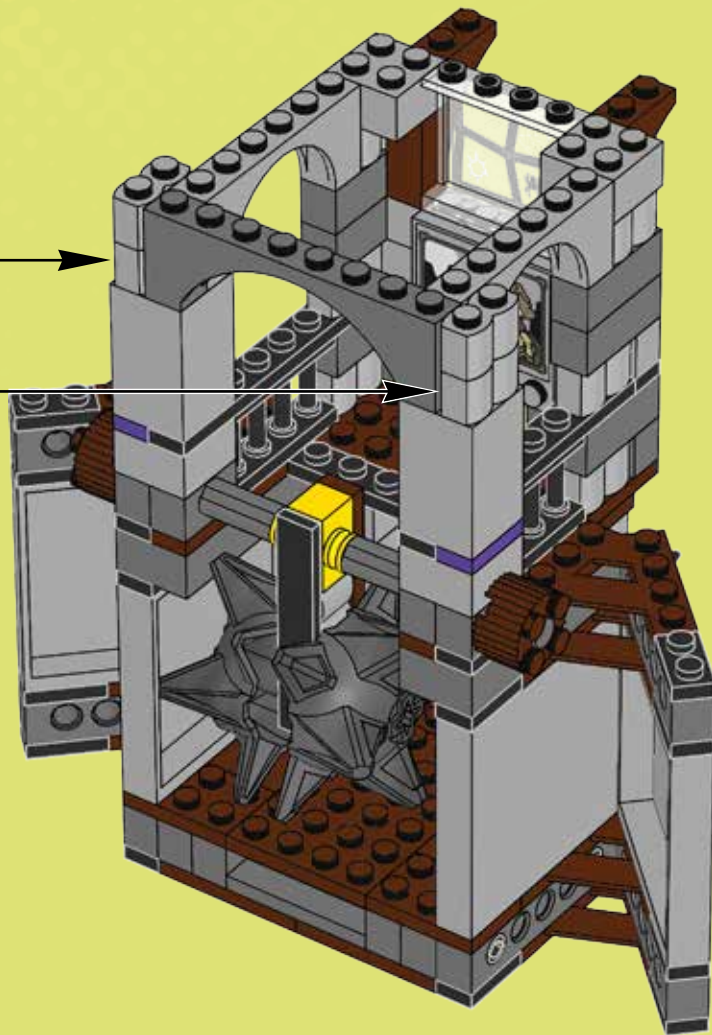



2x

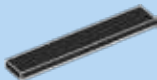

4x

57

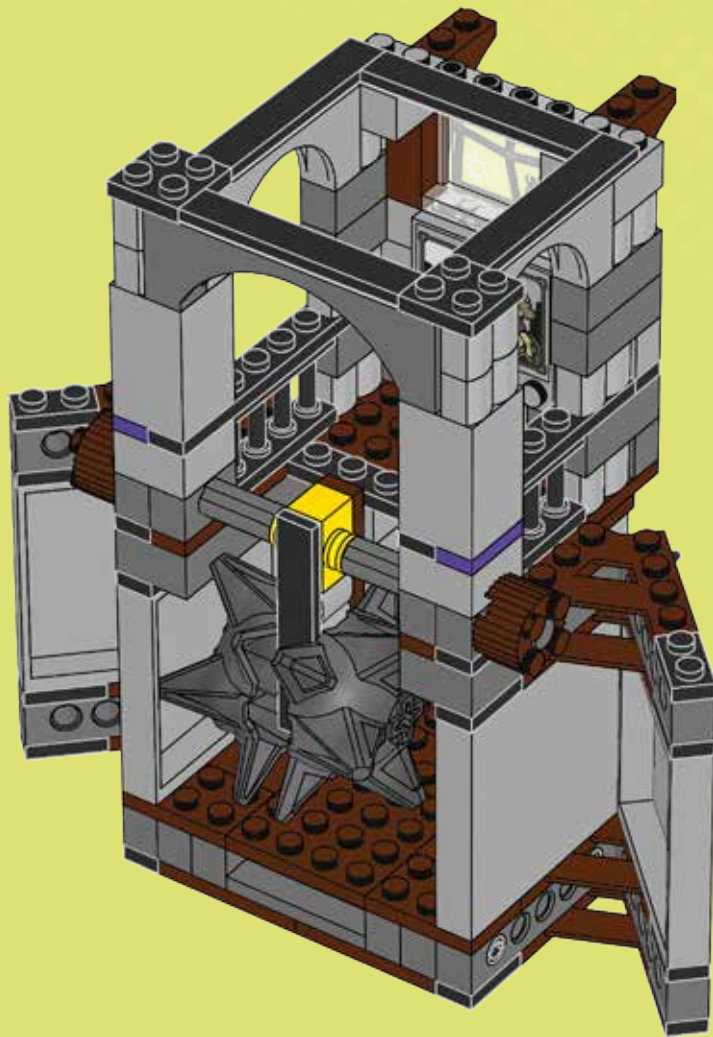

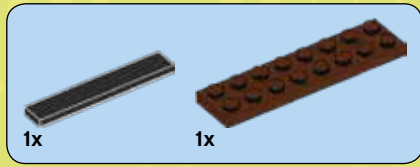

58

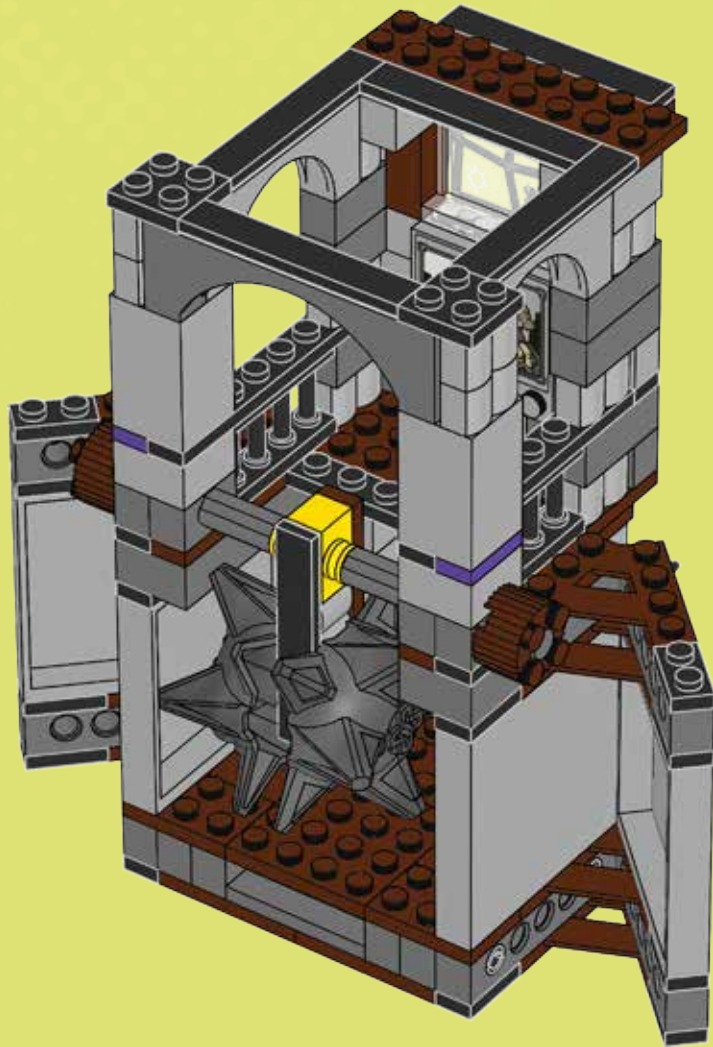



59

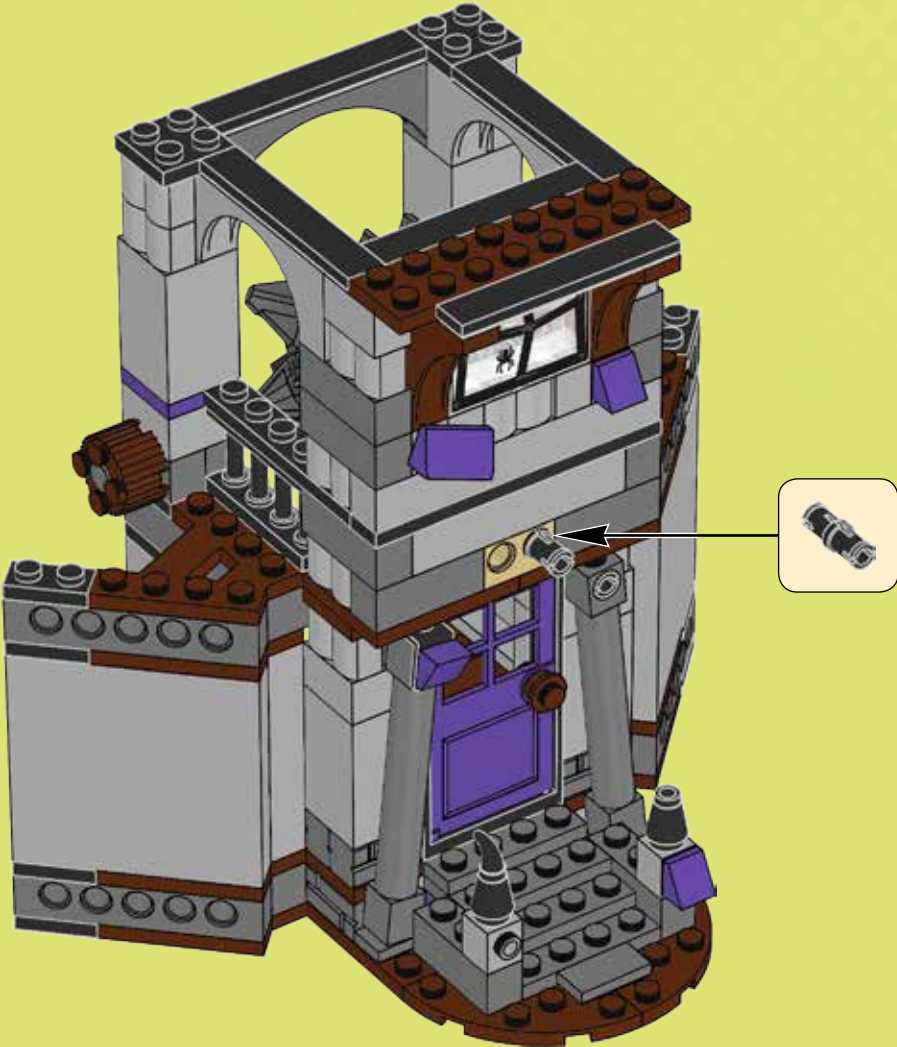



1

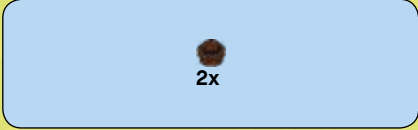

2



3

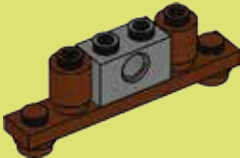

4

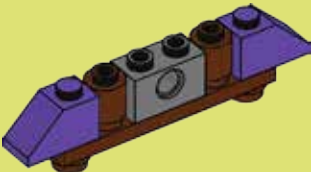



1x



2x

5

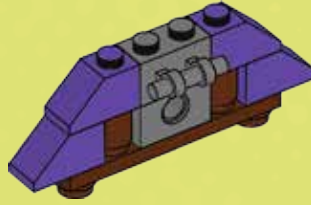

2x

6

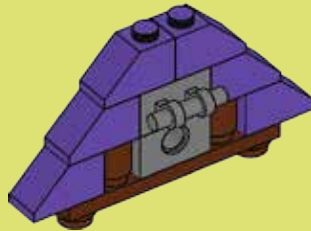

1x



1x

7

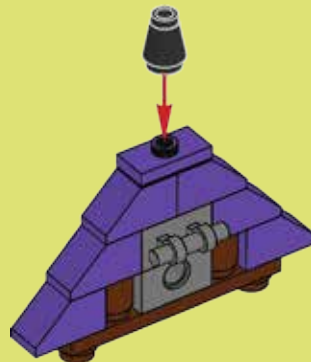



8

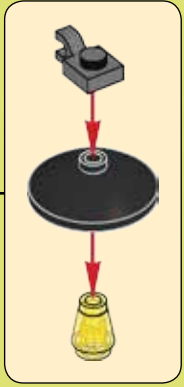
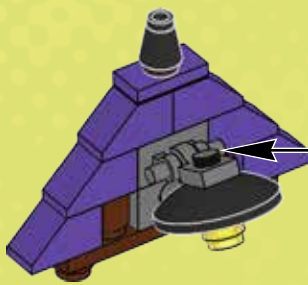

60

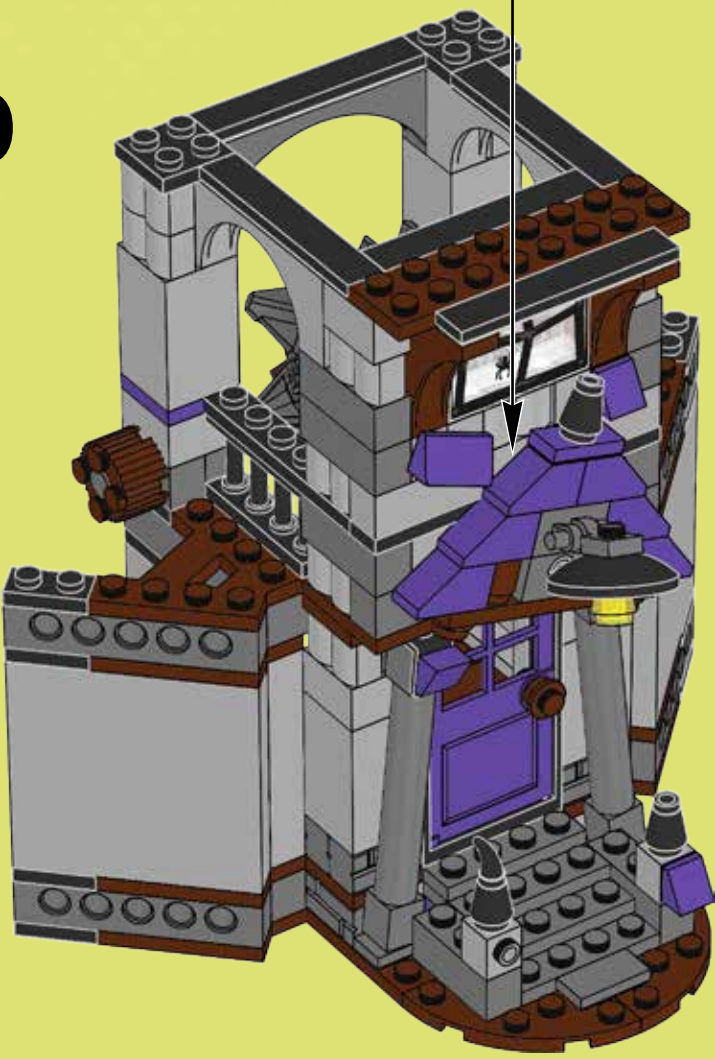

61

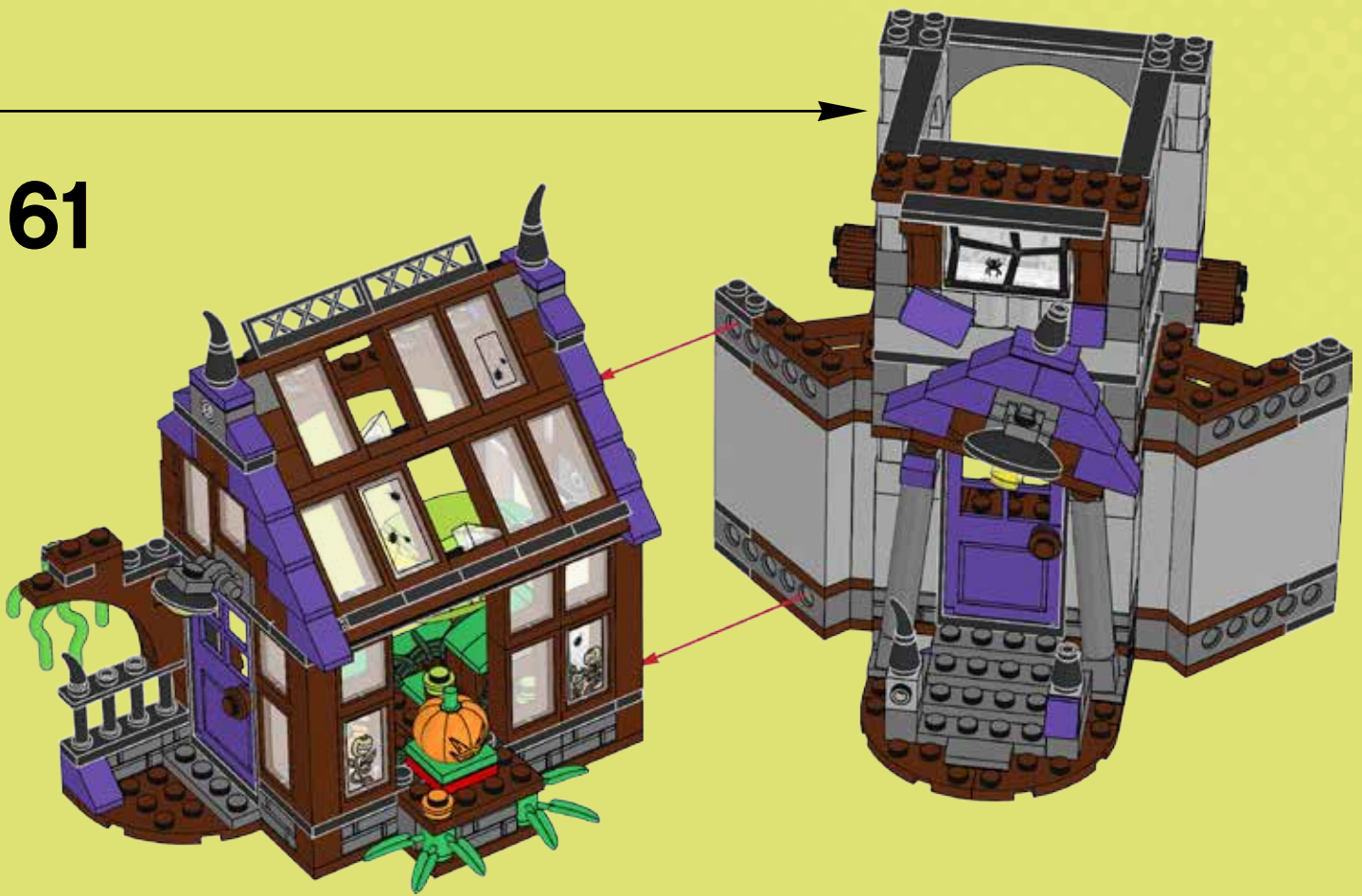

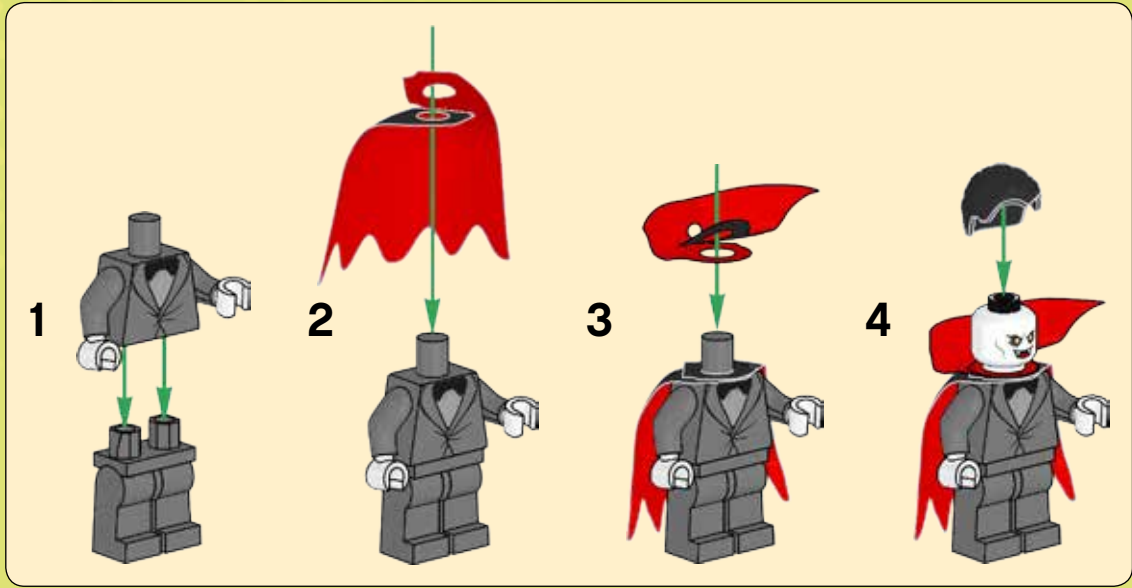
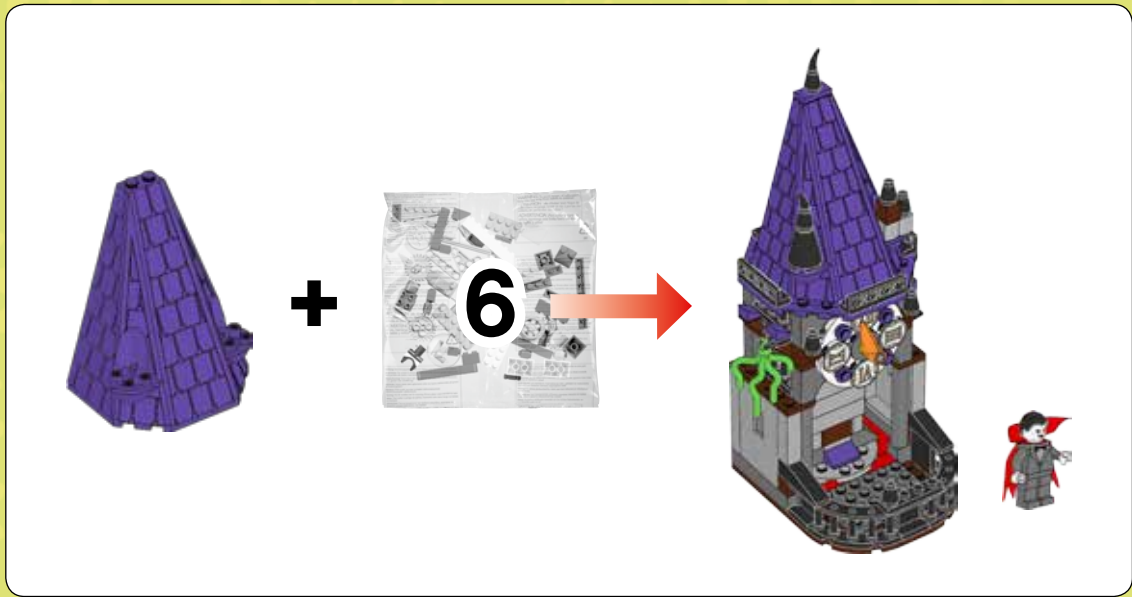

1



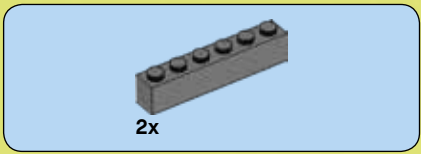

2

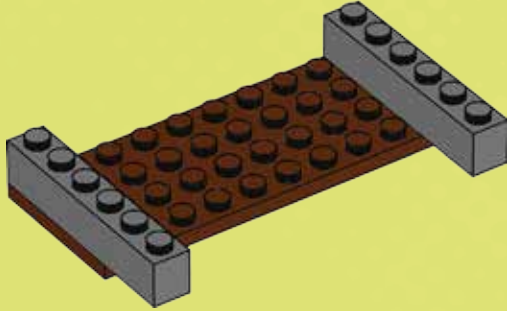

3

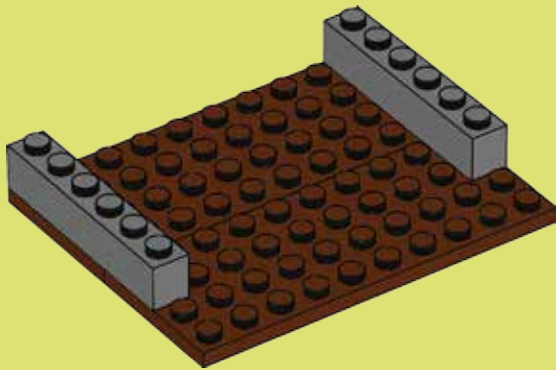

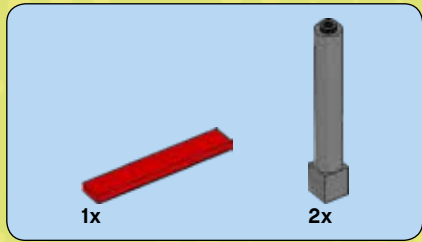

4

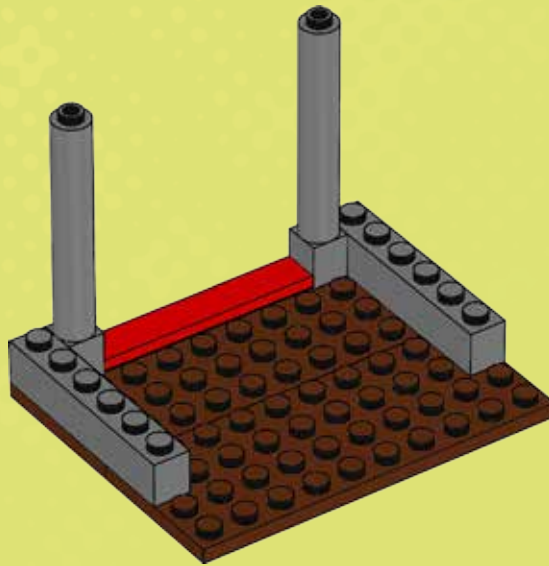

5

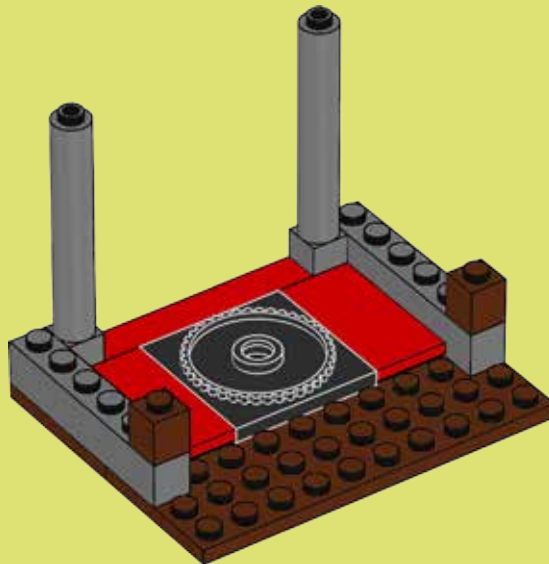

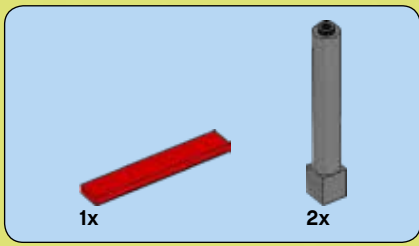

6

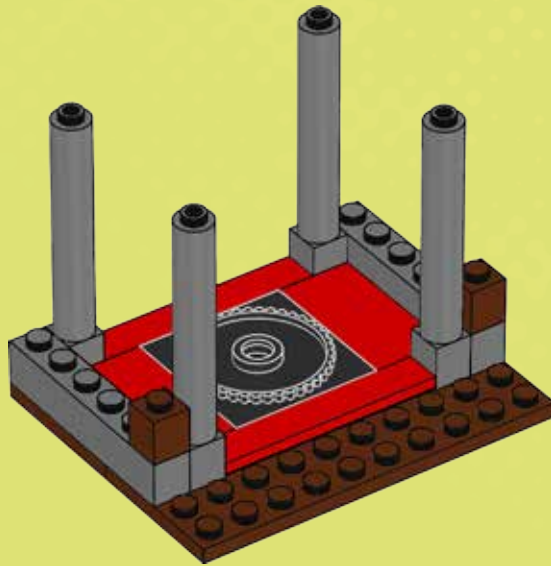

7

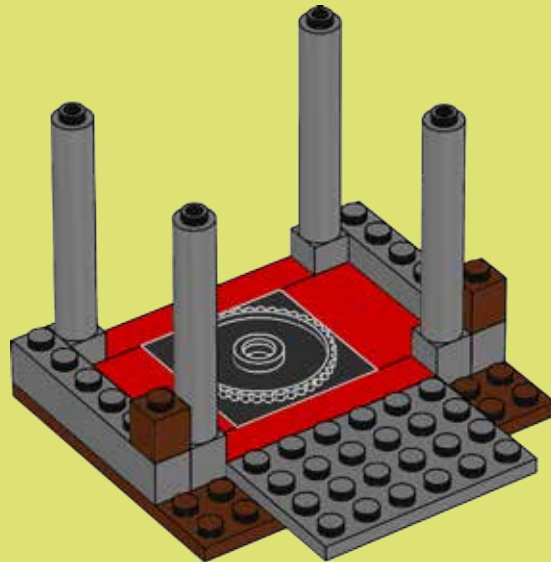



1x

8

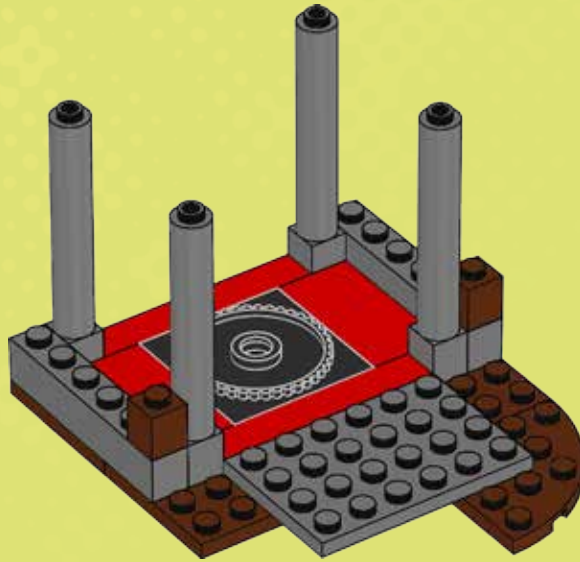

1x



1x

9

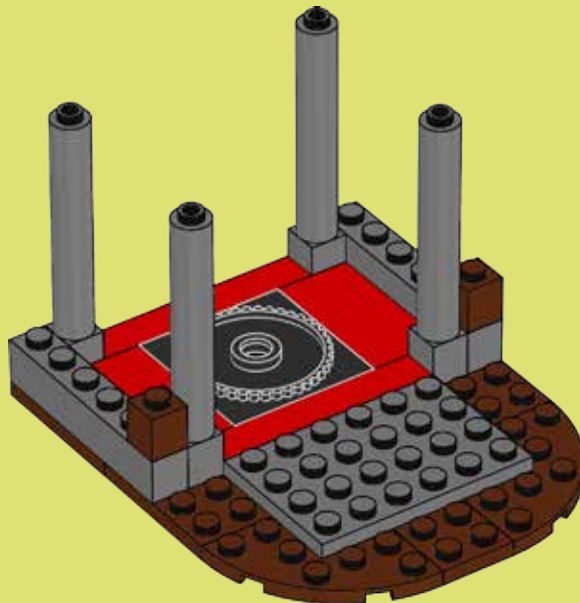



10

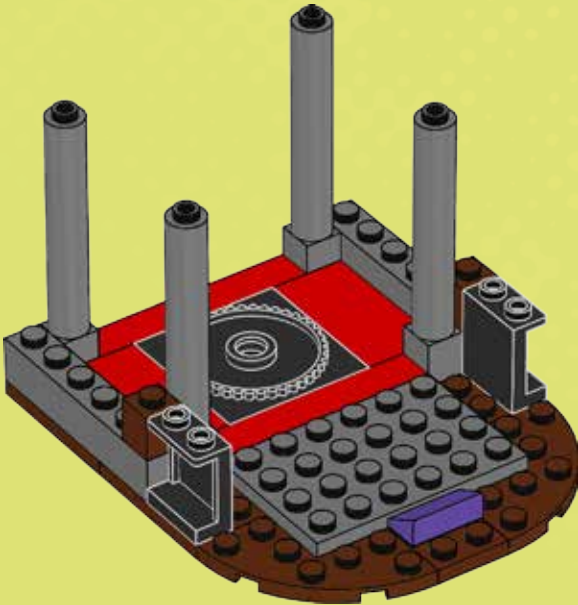

11

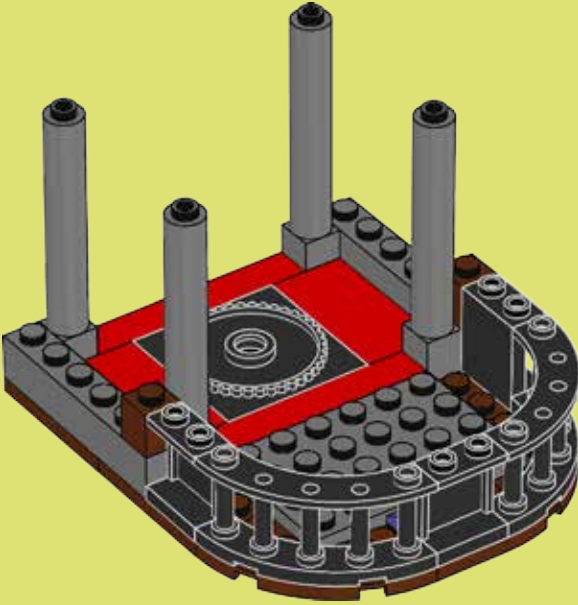



12

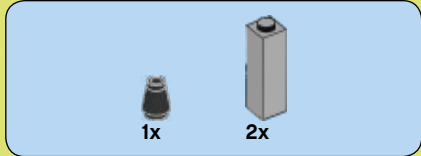
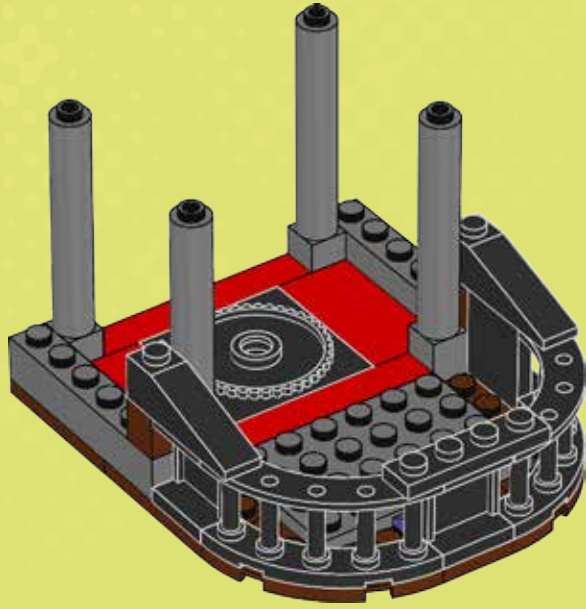

13

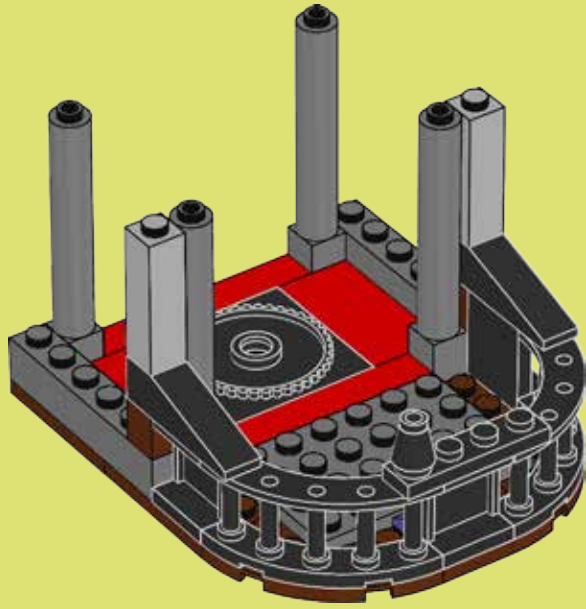

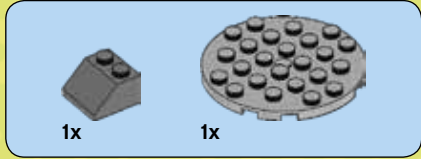
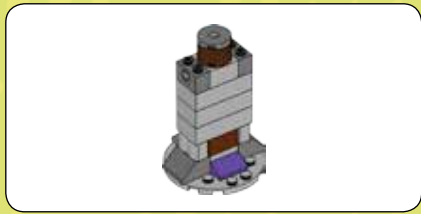

1

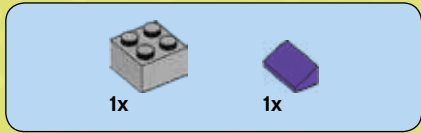
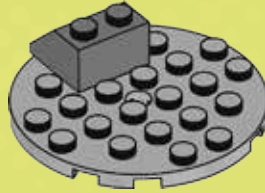

2

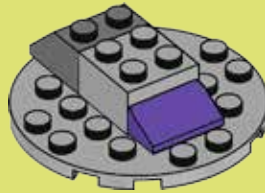

3



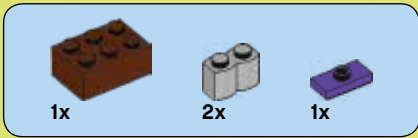

4

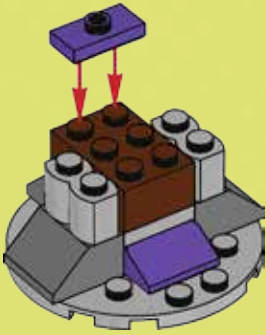

5

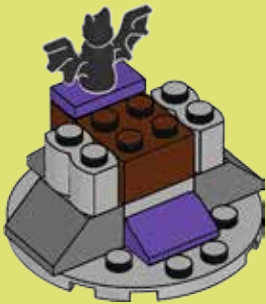



3x

6

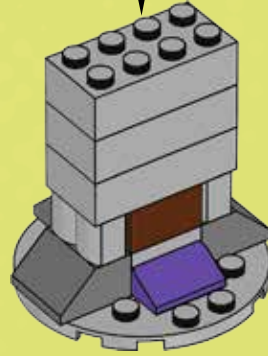
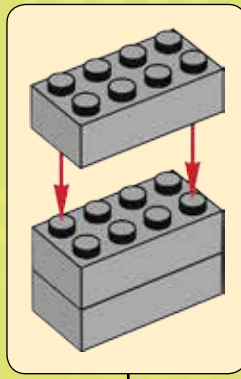

2x

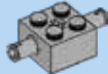

1x

7

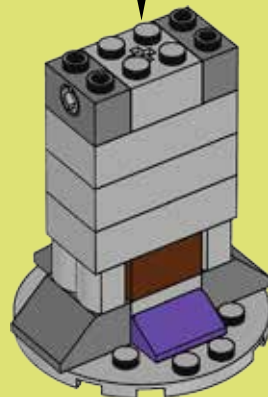
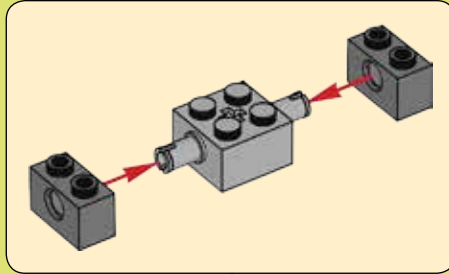



1x



1x

8

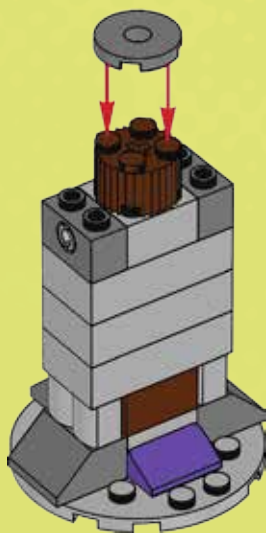

16

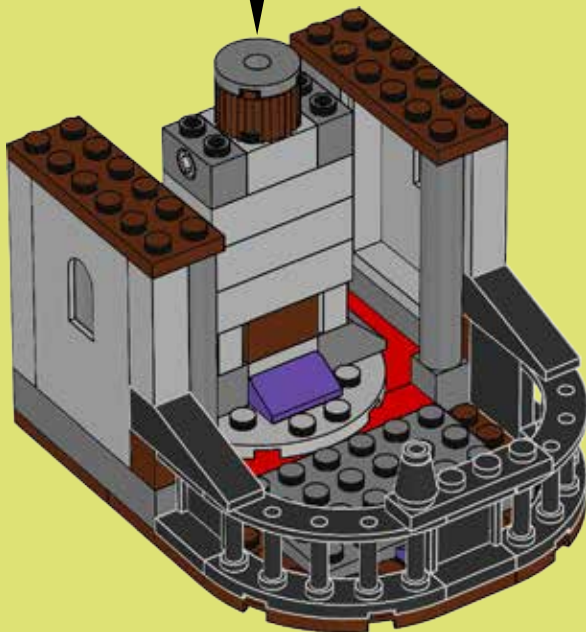

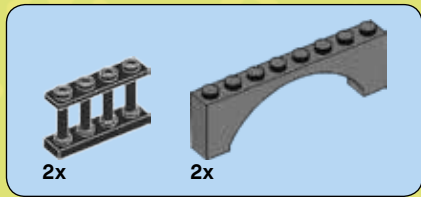

17

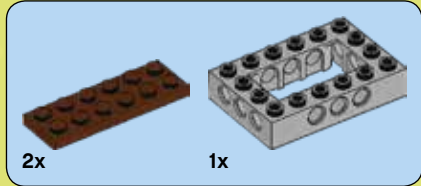
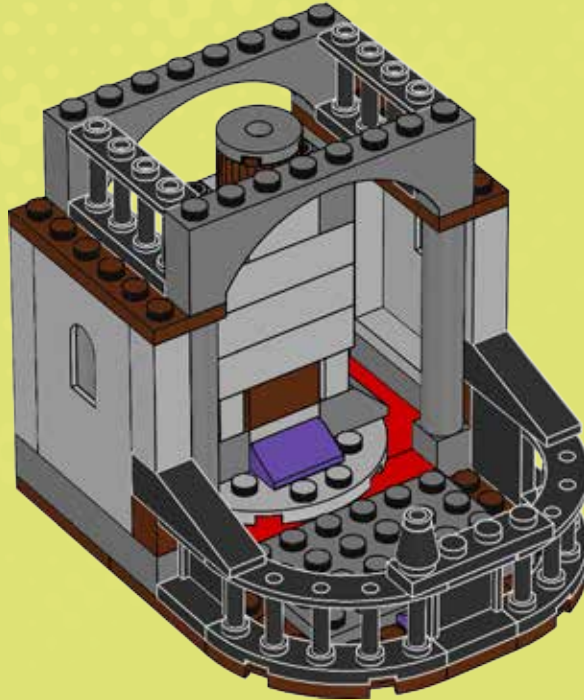

18

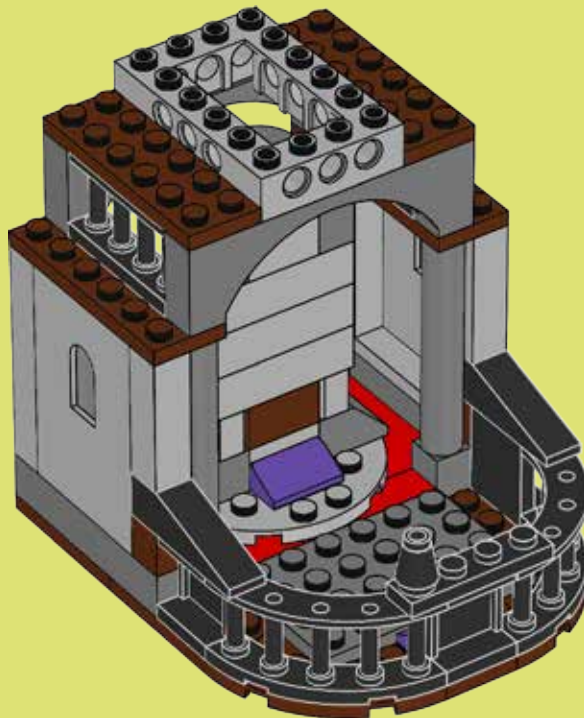



1x

19

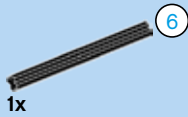
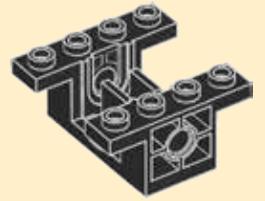
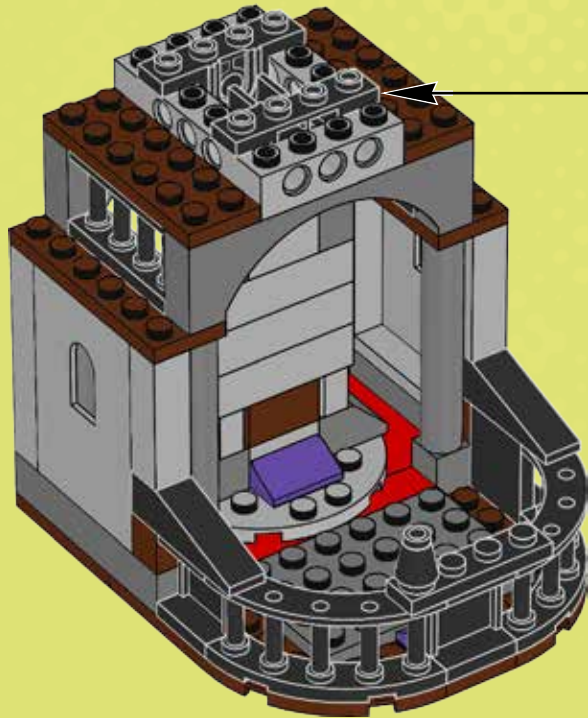

1x

20

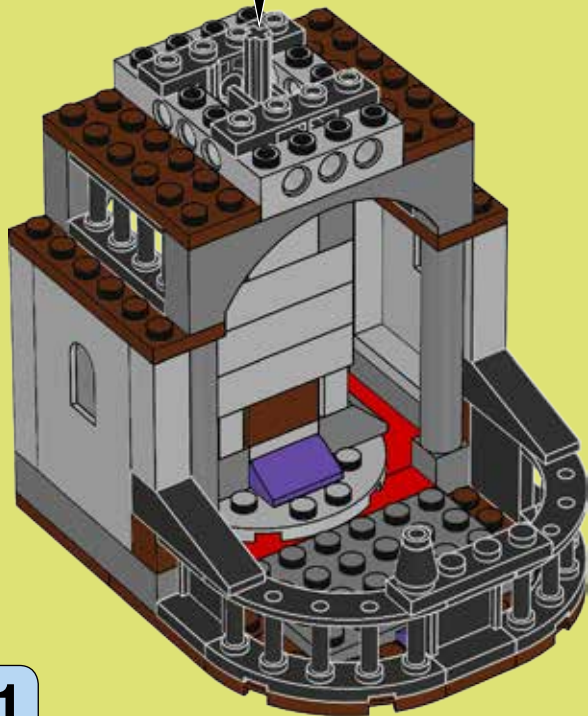

6



6

1:1



2x

21

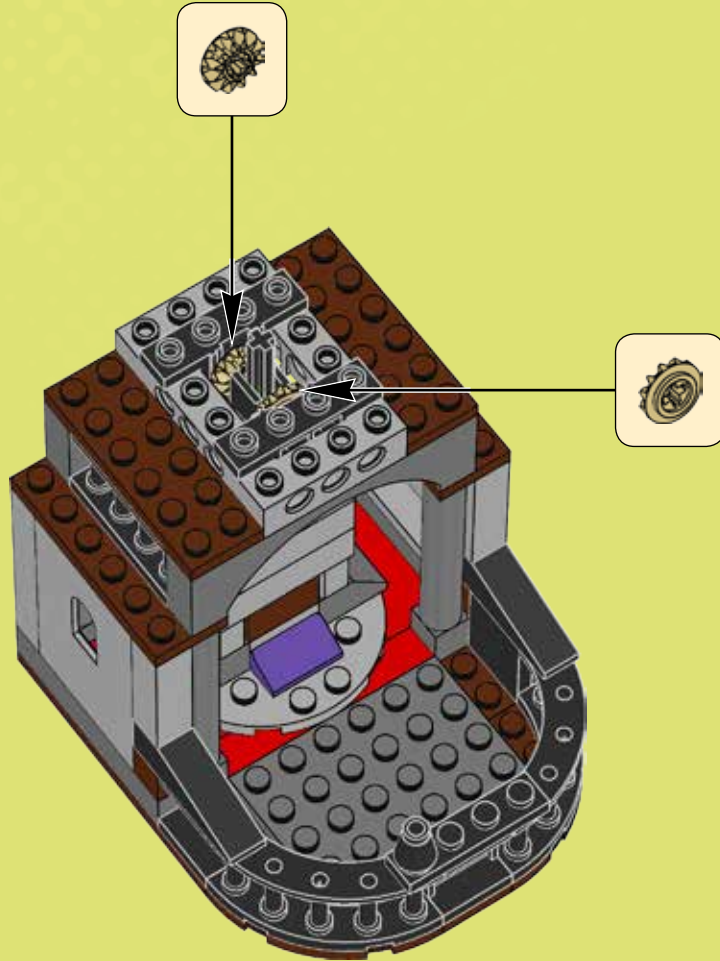



1x

22

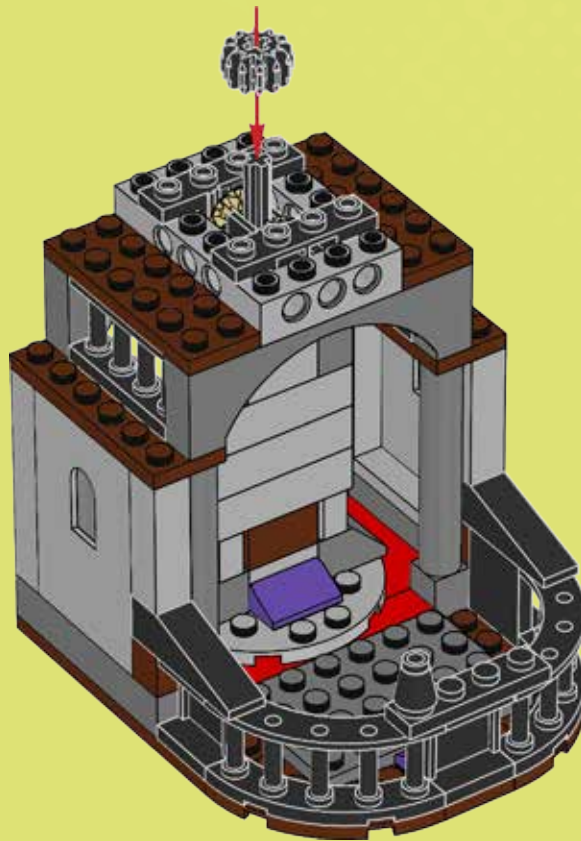

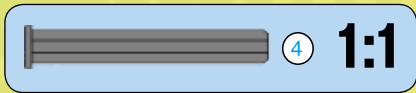

23

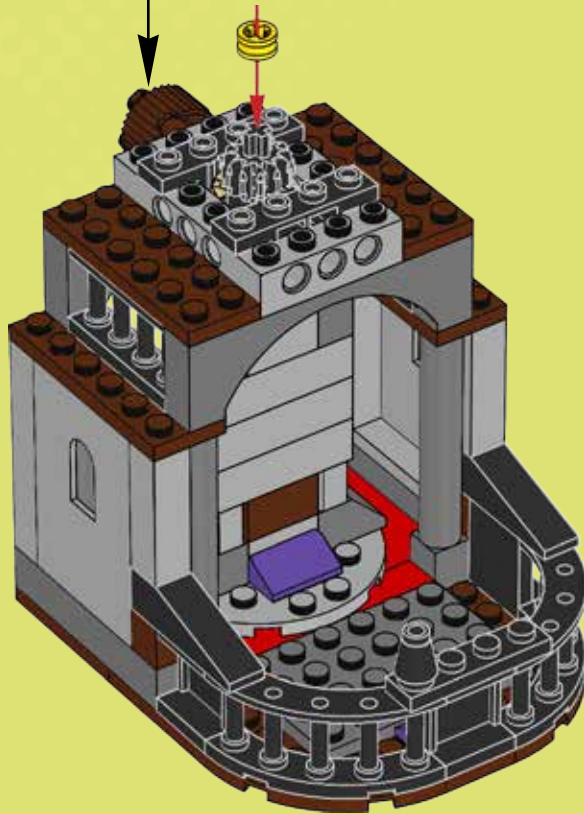
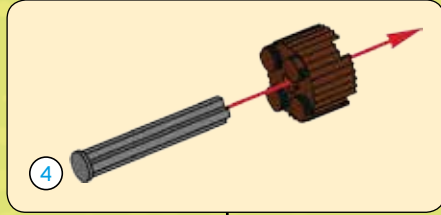



2x

24

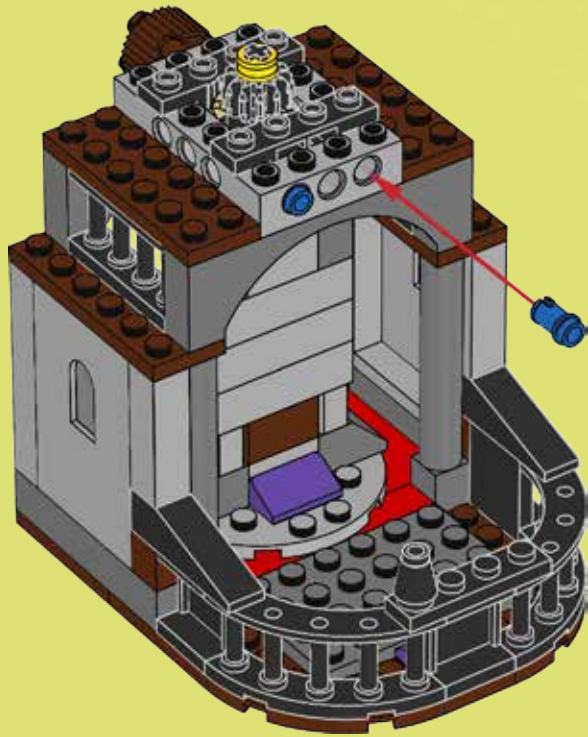

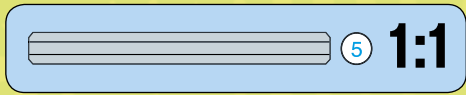
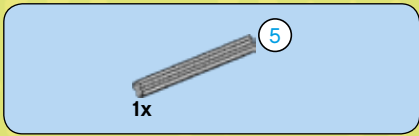

25

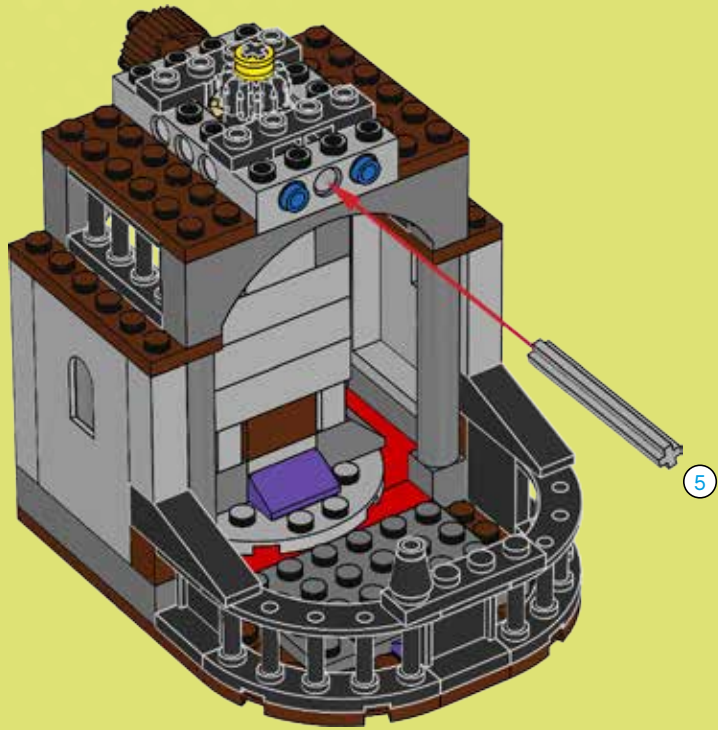



2x

26

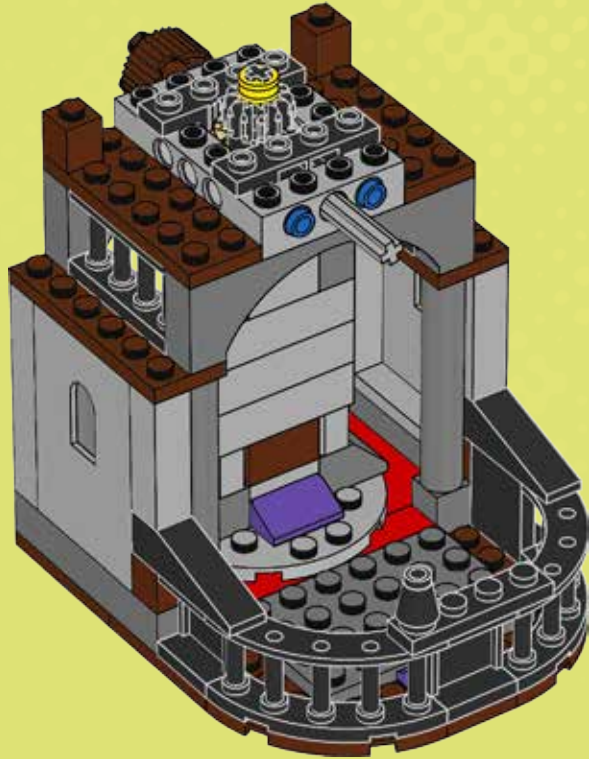

2x



2x

27

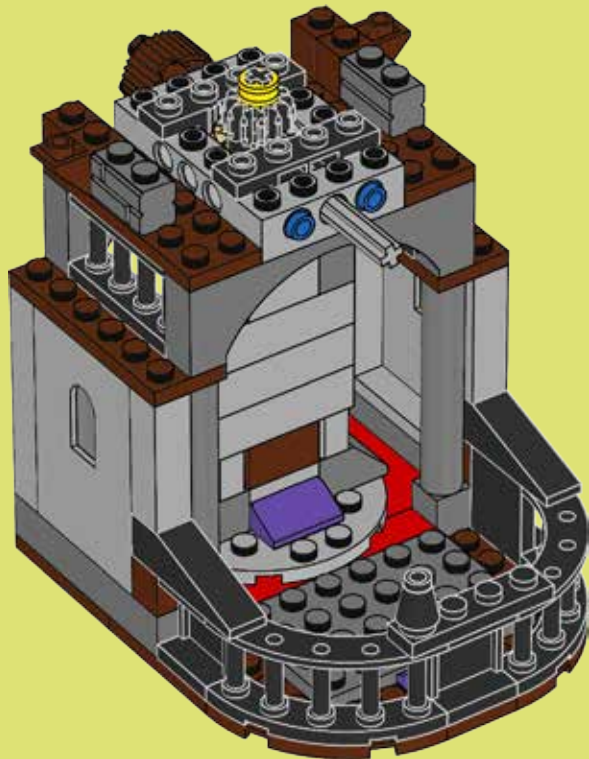



4x

28

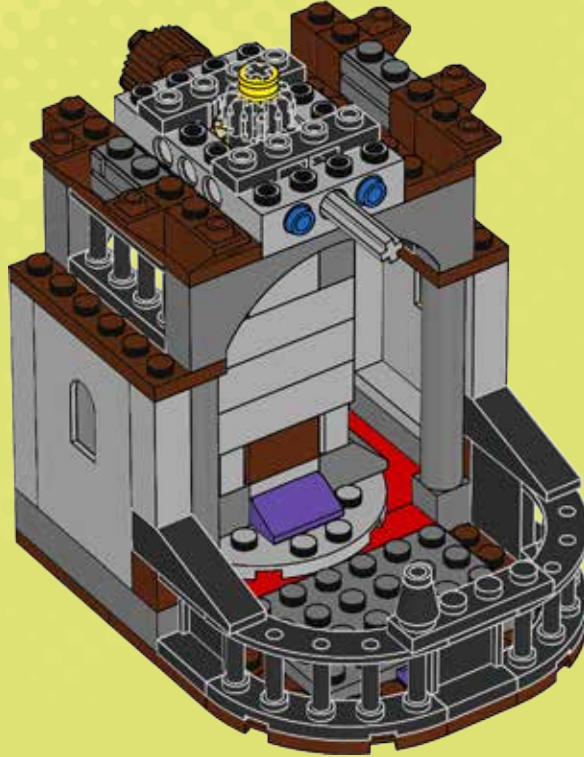

2x



2x

29

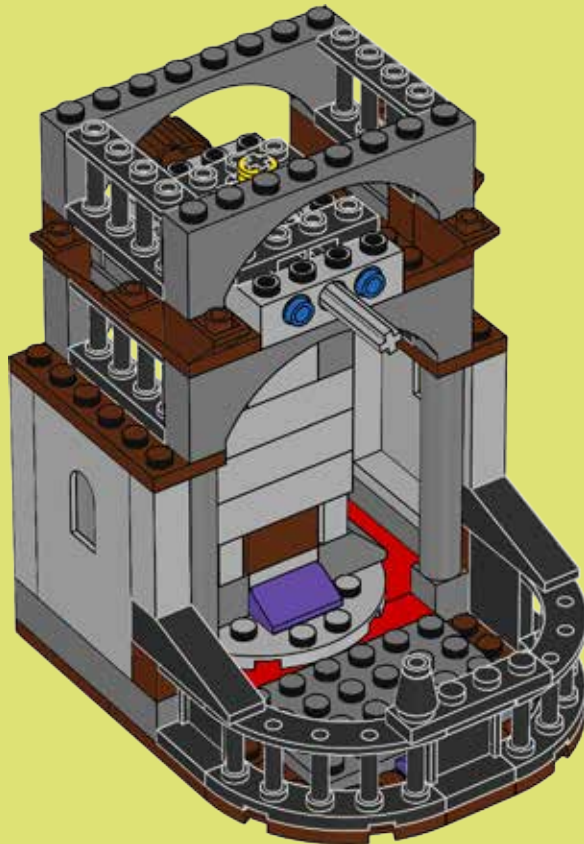



1x



4x

30

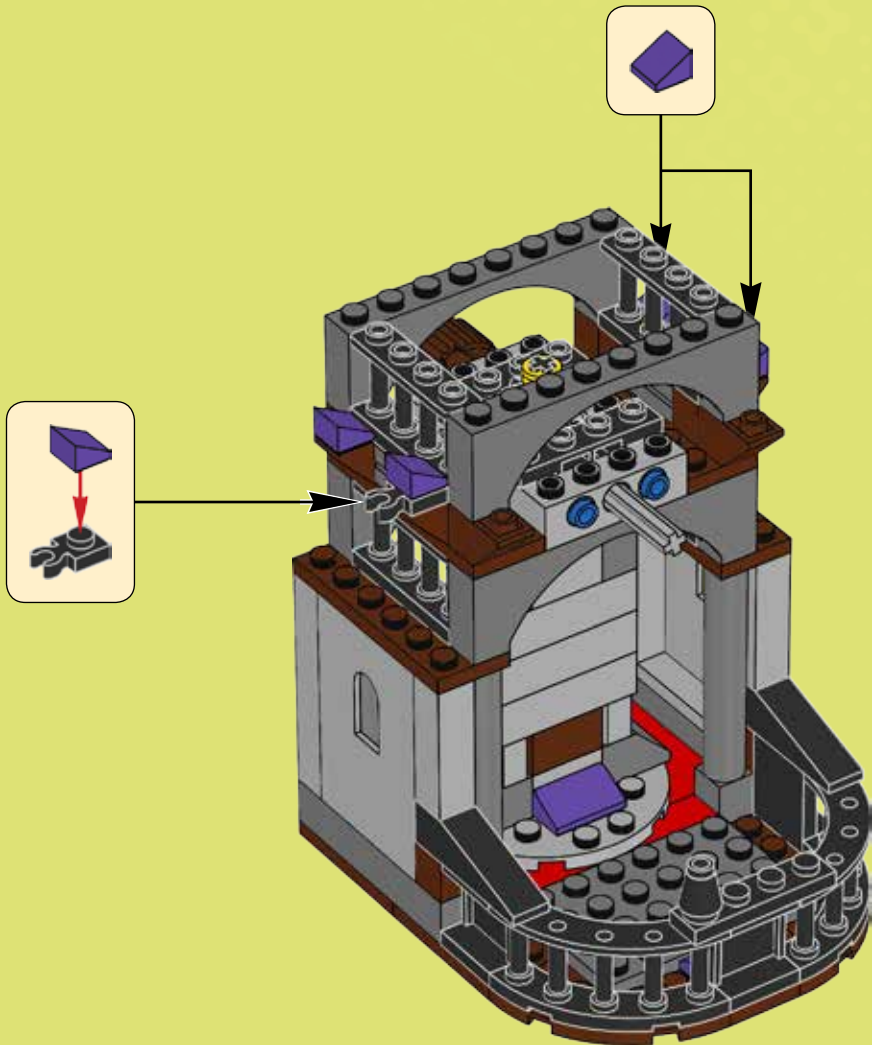

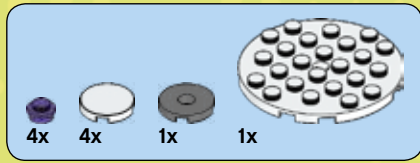

31

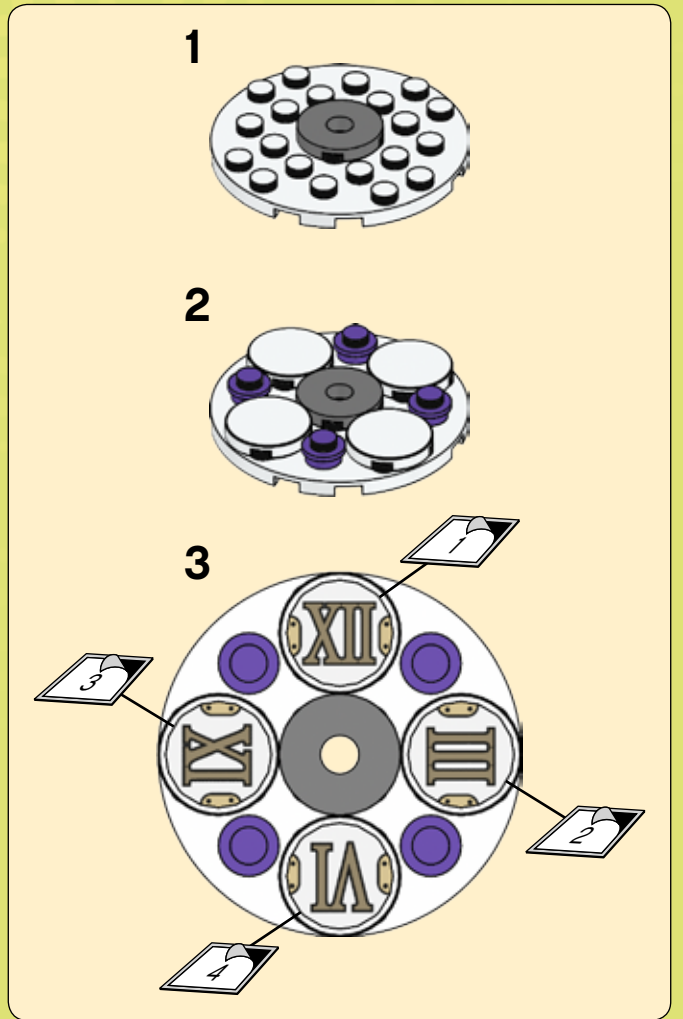
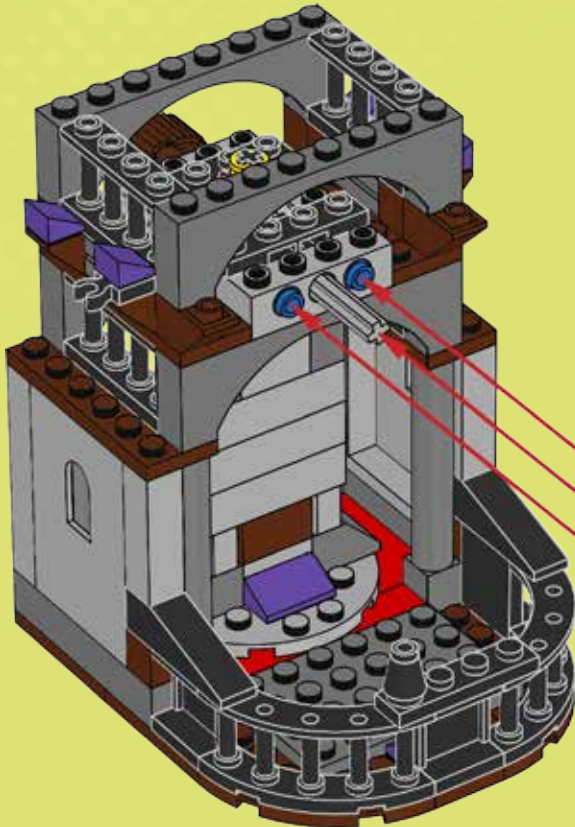



1x



1x

32

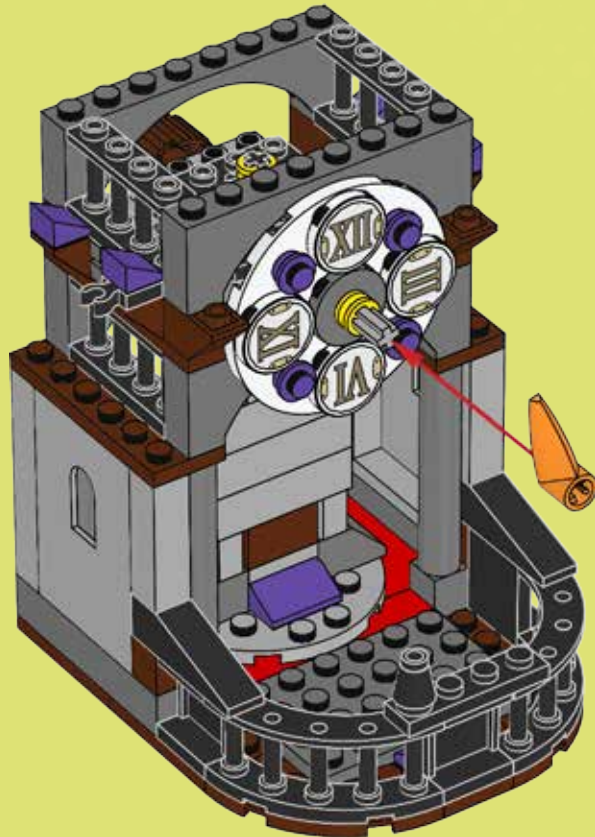

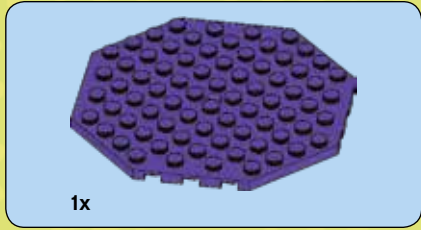

1

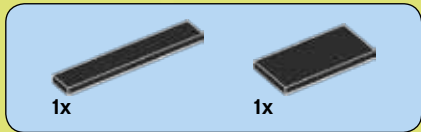
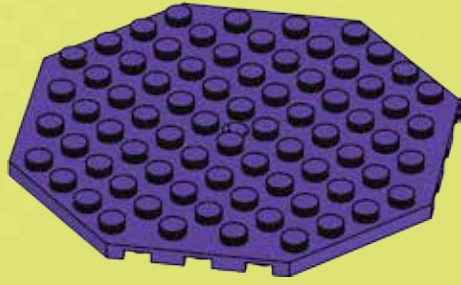

2

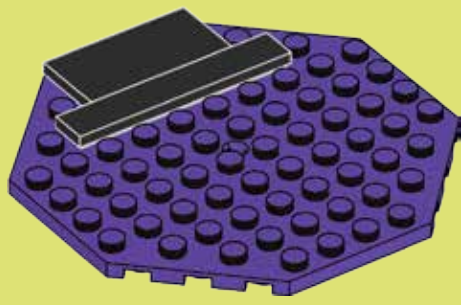



3

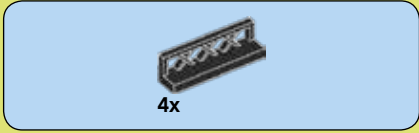
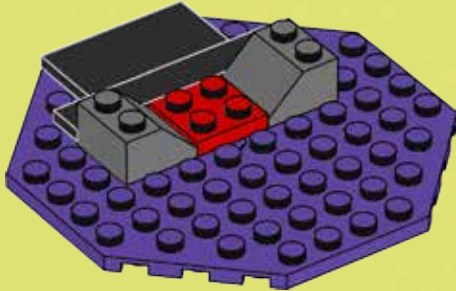

4

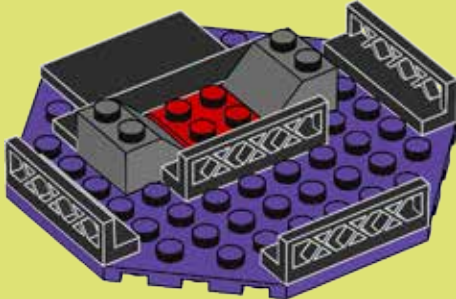

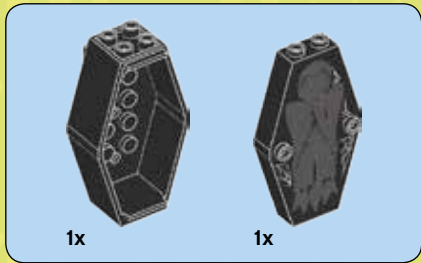

5

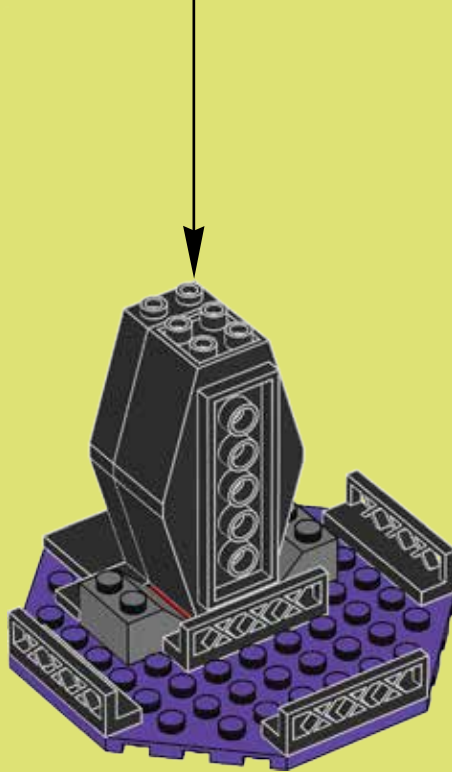
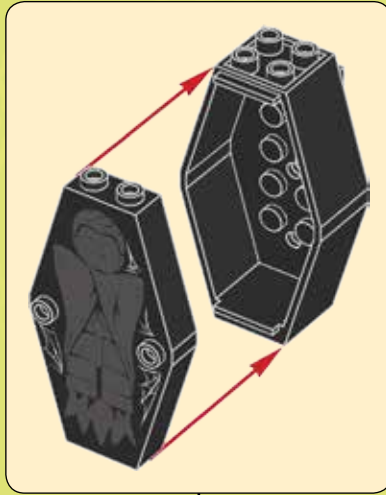

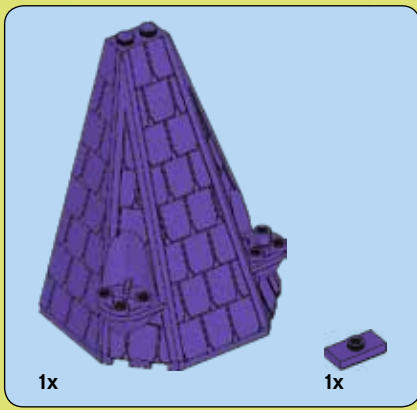

6

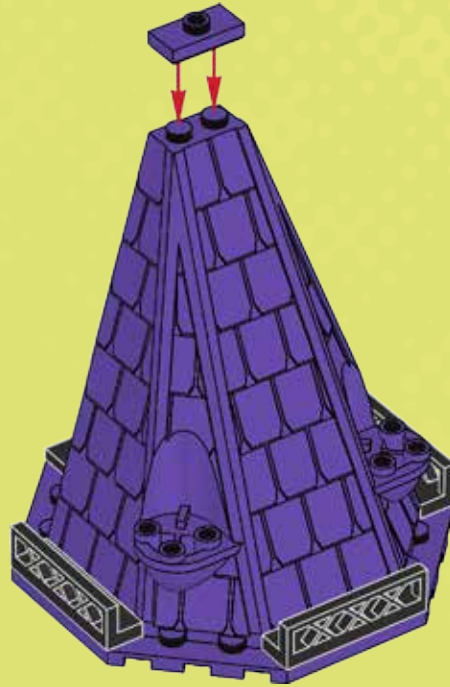

7

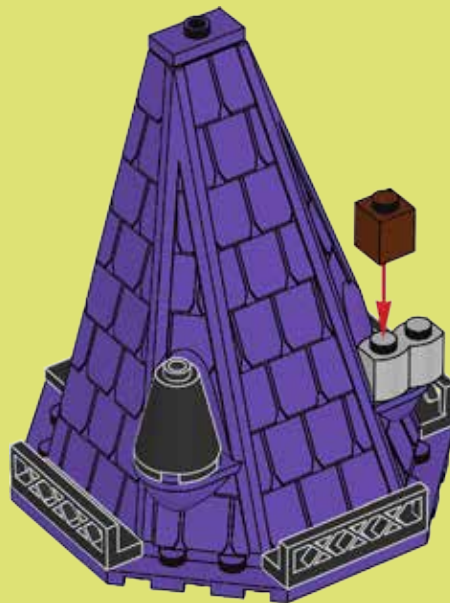



4x

8



2x

9

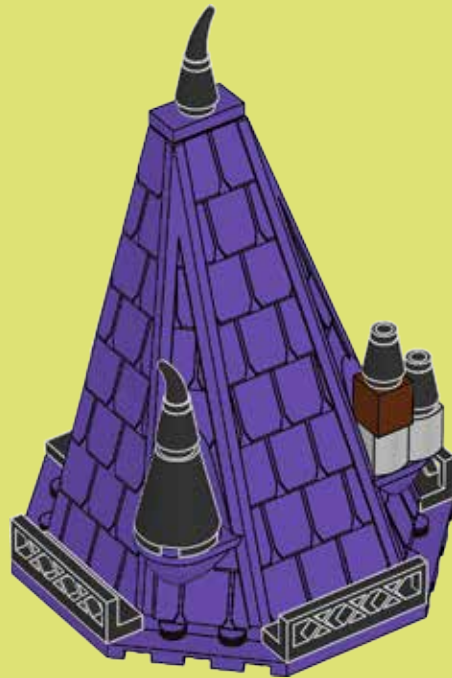

33

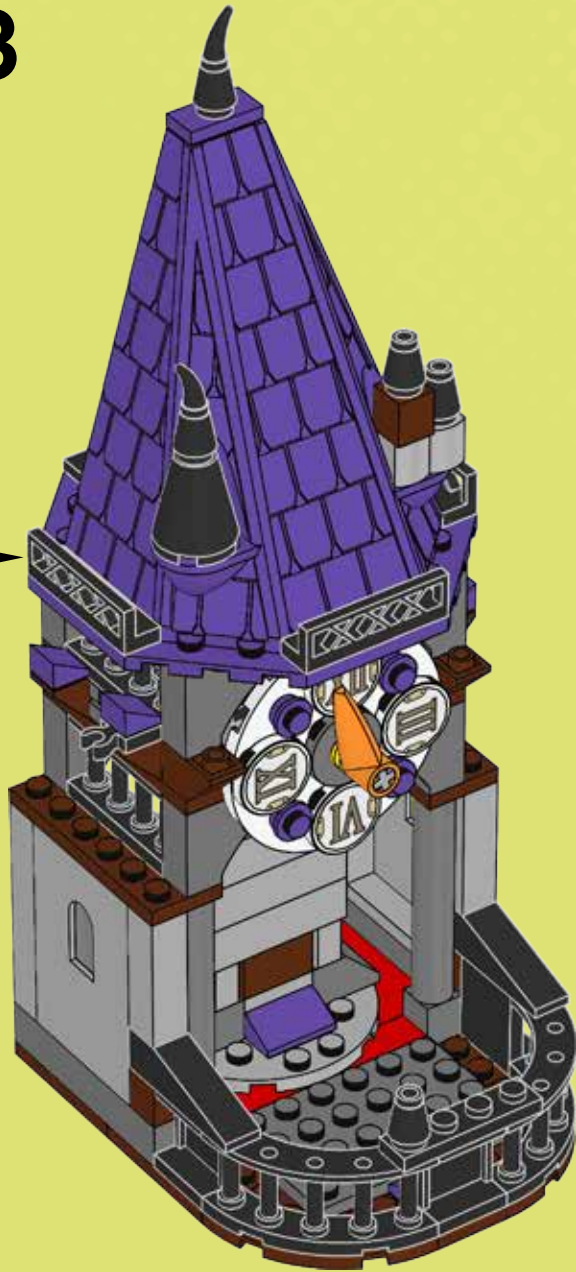



34



35

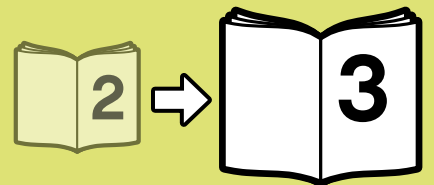



SCOOBY-DOO!

WE'VE GOT A MYSTERY TO SOLVE
NOUS AVONS UN MYSTÈRE À RÉSOUDRE
TENEMOS UN MISTERIO QUE RESOLVER

75900



75901



75902



75903



75904



LEGO.COM/scoobydoo



- 3x 300401
- 1x 300301
- 1x 6123703
- 3x 306801
- 3x 346001
- 4x 6044691
- 1x 6109817
- 2x 623101
- 1x 434601
- 1x 4261470
- 1x 434501
- 1x 4619665
- 1x 9327
- 1x 6009516
- 1x 6122261
- 1x 4651445
- 1x 4600294
- 2x 4143005
- 1x 4523145
- 1x 4113233
- 1x 6115248
- 1x 6122533
- 2x 4565452
- 1x 302221
- 2x 4560179
- 2x 4113858
- 2x 614121
- 2x 4278275
- 1x 6122968
- 1x 4540552
- 1x 4520952
- 1x 368021
- 1x 6119513
- 1x 6119515
- 1x 6012466
- 1x 4541496
- 1x 4233484
- 1x 302224
- 4x 6047218
- 4x 4239601
- 1x 6081988
- 18x 4529236
- 2x 6092664
- 1x 4500978
- 2x 4515362
- 2x 6053077
- 6x 306926
- 15x 302326
- 2x 302226
- 1x 362326
- 5x 371026
- 1x 4560182
- 1x 302026
- 4x 366626
- 7x 663626
- 1x 6066102
- 2x 4550017
- 5x 4107761
- 4x 614126
- 1x 474026
- 1x 4180087
- 1x 4227684
- 3x 4593678
- 1x 4521681
- 2x 4535834
- 1x 6123711
- 1x 6121348
- 1x 4106552
- 1x 4177431
- 8x 346026
- 1x 244526
- 8x 6066113
- 8x 4187209
- 2x 4294570
- 1x 6122408
- 1x 6122463
- 1x 4654944
- 1x 452926
- 1x 6020192
- 9x 4568385
- 1x 4106513
- 1x 4617848
- 2x 6064174
- 1x 393826
- 1x 4517986
- 1x 4500902
- 1x 6055308
- 19x 4121715
- 1x 370526
- 1x 370626
- 1x 6122411
- 1x 4617224
- 2x 4613958
- 1x 6021363
- 2x 6014026
- 2x 4521948
- 2x 4616581
- 1x 4633693
- 1x 6121349
- 1x 6119136
- 1x 6117569
- 1x 6117589
- 1x 6092599
- 2x 4157103
- 1x 6122416
- 1x 6122725
- 2x 6122207
- 1x 4281515
- 1x 4654448

4

6

2x
6047426
 1x
6021539
 3x
306928
 1x
302328
 2x
4565321
 1x
371028
 2x
243128
 1x
4296081
 2x
4556159
 2x
4521931
 2x
4114348
 3x
6059027
 1x
6092601
 3x
4179825
 4x
4581079
 2x
4255624
 1x
4569217
 1x
4505066
 2x
4294148

4x
4216581
 8x
6084573
 5x
4636170
 2x
4211189
 3x
4211190
 6x
4211194
 3x
4211186
 1x
4211204
 2x
4221590
 5x
4243838
 7x
4211247
 4x
4211211
 2x
4217848
 3x
4223683
 4x
4223729
 4x
4225715
 1x
4225700

30x
4211242
 3x
4226966
 9x
4211180
 1x
4216668
 2x
4225469
 2x
4211183
 4x
6036503
 1x
4504376
 1x
4270470
 6x
4211222
 1x
6121737
 1x
4598713
 1x
4211202
 2x
4211197
 4x
6055086
 2x
6044725
 3x
6096379

3x
4211150
 1x
4211151
 2x
4271949
 1x
4211257
 1x
4211152
 13x
6058084
 6x
4595814
 2x
6061702
 2x
4211362
 42x
4550325
 2x
4211564
 8x
4211387
 4x
4211650
 7x
4211394
 5x
4211385
 10x
4211393
 1x
4211392

12x
4558953
 2x
4533772
 1x
4211752
 1x
4211716
 2x
6007894
 2x
6106189
 1x
6063898
 1x
4211395
 1x
4211837
 1x
6043656
 4x
4211376
 1x
6015349
 2x
4537056
 4x
4527174
 1x
4211503
 1x
4610112

- 1x 4512743
- 2x 4590443
- 1x 4540203
- 1x 4211469
- 1x 4563045
- 1x 4211758
- 1x 4211807
- 1x 4211815
- 1x 4211639
- 1x 4164022
- 2x 4212446
- 2x 6023954
- 1x 4164037
- 1x 4537936
- 9x 4183133
- 1x 6117683
- 2x 4619513
- 2x 4625036
- 1x 6070379
- 1x 6070380

- 23x 6000311
- 22x 4211104
- 1x 4211085
- 2x 4211100
- 2x 4210875
- 2x 4211128
- 1x 4210725
- 6x 4180811
- 6x 4210639
- 23x 4211111
- 8x 4210917
- 5x 4211054
- 5x 6079721
- 1x 6092649
- 2x 4210848
- 1x 4211052
- 2x 4211001
- 3x 4211065

- 1x 4243831
- 1x 4211115
- 3x 4579354
- 1x 6039479
- 1x 6039482
- 2x 6055313
- 2x 4222693
- 1x 6122280
- 2x 4516546
- 4x 6083620
- 2x 6109820
- 1x 6109819
- 4x 6109812
- 1x 6029584
- 1x 6056448

- 15x 4567509
- 7x 4566607
- 6x 6022070
- 25x 6109814
- 2x 6055877
- 2x 4655695
- 6x 6092604
- 4x 4566522
- 1x 6122746
- 1x 6122736
- 1x 6123944
- 1x 6122731
- 1x 6122133
- 1x 6004714
- 1x 6022033
- 3x 6051823
- 1x 6005030

- 2x 4244362
- 2x 3005740
- 13x 4536998
- 6x 6024020
- 2x 6000740
- 3x 6010737
- 1x 6054554
- 1x 4594686
- 1x 4504229
- 1x 4567332
- 1x 3005744
- 2x 6039180
- 1x 6055651



Customer Service
Kundenservice
Service Consommateurs
Servicio Al Consumidor

LEGO.com/service or dial
: 00800 5346 5555
: 1-800-422-5346



More spooky fun at LEGO.com/scoobydoo
Plus d'amusement effrayant sur LEGO.fr/scoobydoo
Más diversión tenebrosa en LEGO.com/scoobydoo



SCOOBY-DOO!

LEGO and the LEGO logo are trademarks of the/son des marques de commerce du/son marcas registradas de LEGO Group. ©2015 The LEGO Group. 6132711

TM/MC & © Hanna-Barbera.
WB SHIELD: TM/MC & © Warner Bros. Entertainment Inc.
MR y © Hanna-Barbera.
WB SHIELD: MR y © Warner Bros. Entertainment Inc.
(s15)

Apple, the Apple logo, iPad, iPhone and iPod touch are trademarks of Apple Inc. Apple, le logo Apple, iPad, iPhone et iPod touch sont des marques de commerce d'Apple Inc. Apple, el logotipo de Apple, iPad, iPhone e iPod touch son marcas comerciales de Apple Inc. Google Play is a trademark of Google Inc. Google Play est une marque de commerce de Google Inc. Google Play es una marca comercial de Google Inc.

