



**MARVEL**

76296



Q LEGO® Builder



### **Get excited about our new packaging!**

We're switching from plastic to paper-based packaging. That's why you might find a mix of paper and plastic in our boxes!

### **Nos nouveaux emballages vous emballeront !**

Nous passons des emballages en plastique aux emballages à base de papier. C'est pourquoi vous pourriez trouver un mélange de papier et de plastique dans nos boîtes !

### **¡Te presentamos nuestros nuevos empaques!**

Estamos sustituyendo las bolsas de plástico por bolsas con base de papel. ¡Por eso, puedes encontrar una mezcla de papel y de plástico en nuestras cajas!

**[LEGO.com/sustainable-packaging](https://www.lego.com/sustainable-packaging)**

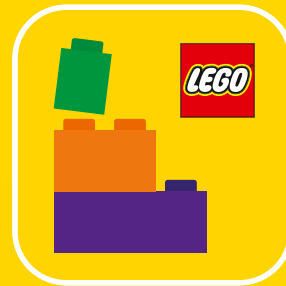

# BUILDER



Apple and the Apple logo are trademarks of Apple Inc., registered in the U.S. and other countries and regions. App Store is a service mark of Apple Inc. Google Play and the Google Play logo are trademarks of Google LLC. Tencent and the Tencent logo are trademarks of Tencent Inc.

[LEGO.com/devicecheck](https://www.lego.com/devicecheck)

**EN** Ask parents' permission before going online | **DE** Eltern um Erlaubnis bitten, bevor du online gehst | **FR** Demande l'autorisation d'un parent avant d'aller en ligne | **IT** Chiedi il permesso ai tuoi genitori prima di andare online | **ES** Pídeles permiso a tus papás antes de conectarte a Internet | **PT** Peça autorização aos pais antes de acederes online | **ZH** 上网前应先征得父母的同意 | **PL** Poproś rodziców o zgodę, zanim wejdiesz do Internetu | **CS** Než půjdeš na internet, požádej rodiče o svolení | **SK** Skôr než pôjdeš na internet, vypýtaj si povolenie od rodičov | **HU** Kérj szülői engedélyt, mielőtt online csatlakoznál! | **RO** Cere permisiunea părinților înainte de a te conecta online | **BG** Поискайте разрешение от родител, преди да влезете онлайн | **LV** Pirms došanās tiešsaistē palūdz atļauju vecākiem | **ET** Enne Interneti kasutamist küsi vanematelt luba | **LT** Prieš prisijungdami prie interneto, atsklauskite tėvų

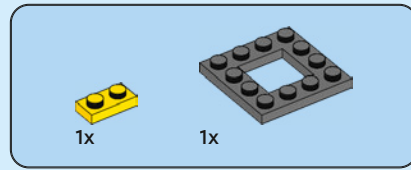

1

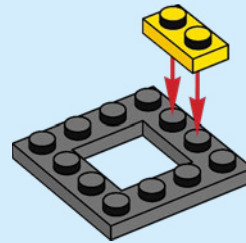

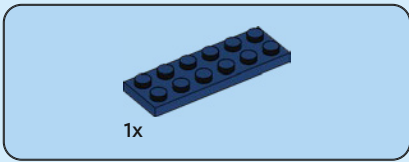

2

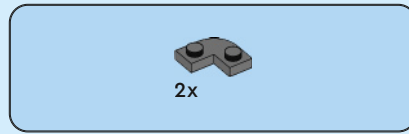
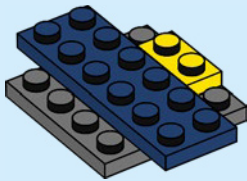

3

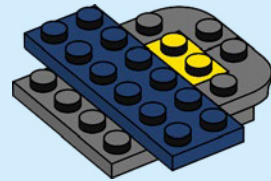

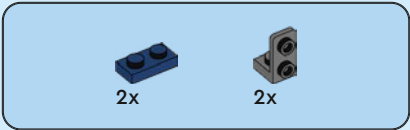

4

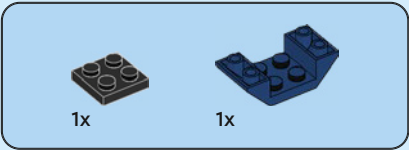
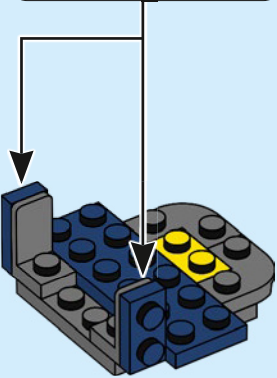
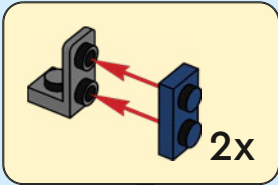

5

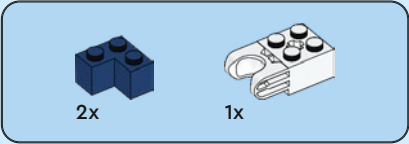
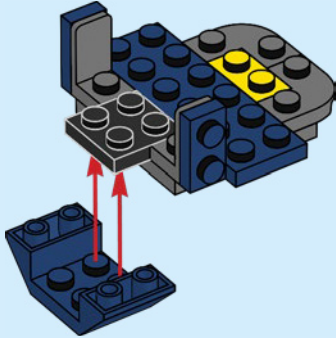

6

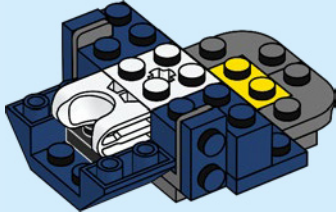



2x

7

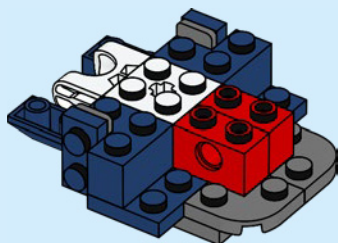

4x

8

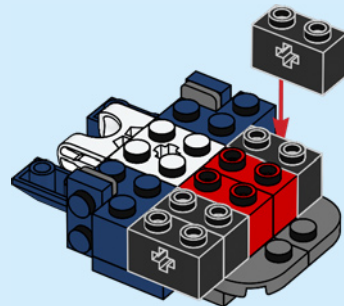

1x

9

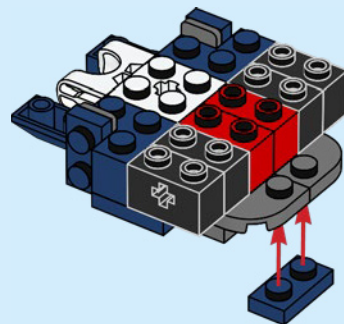



10

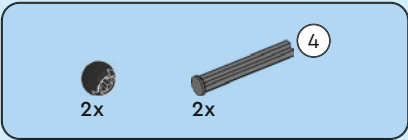
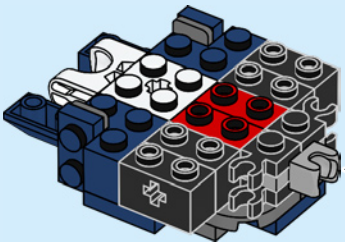
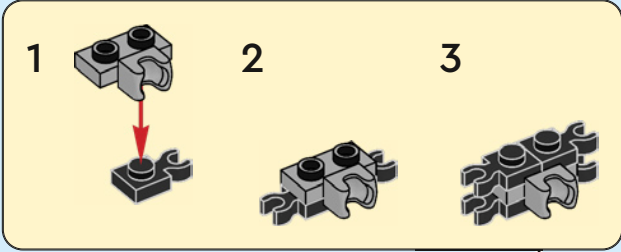

11

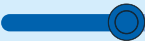
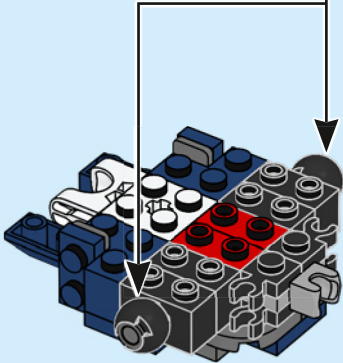
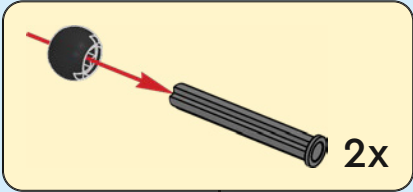



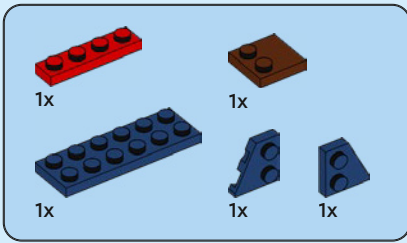

12

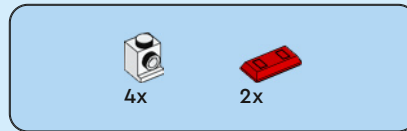
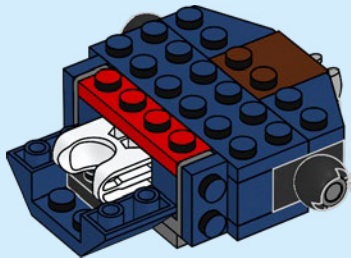

13

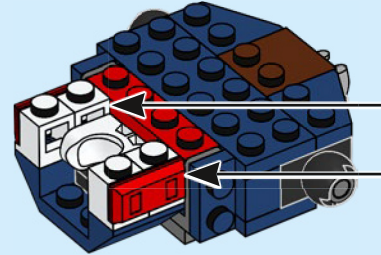
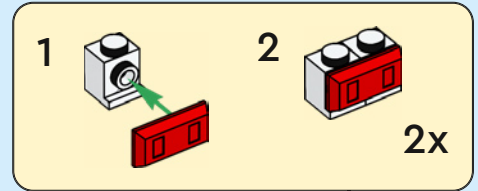

14

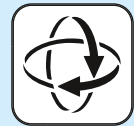
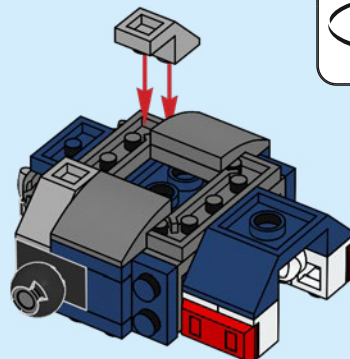

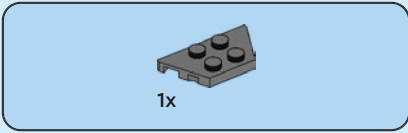

15

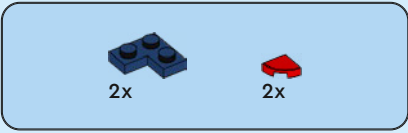
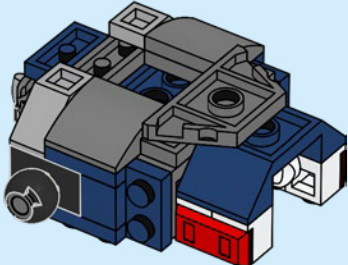

16

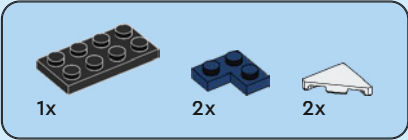
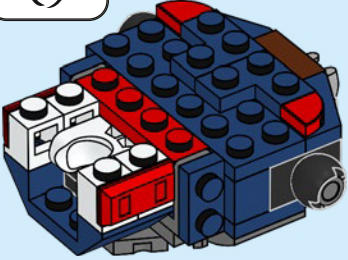

17

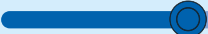
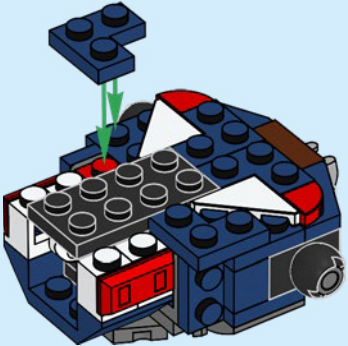

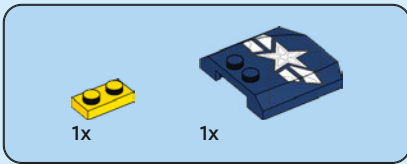

18

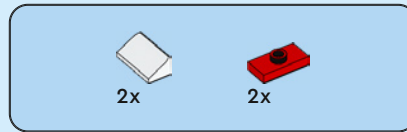
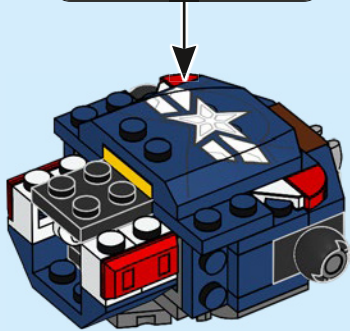
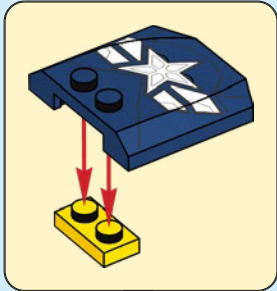

19

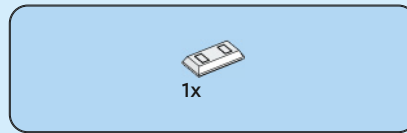
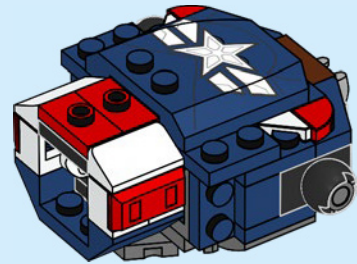

20

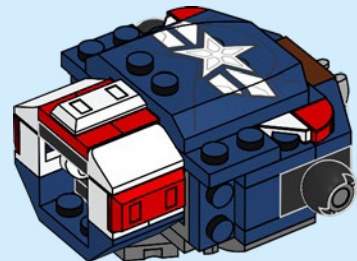

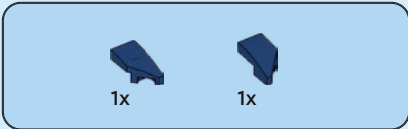

21

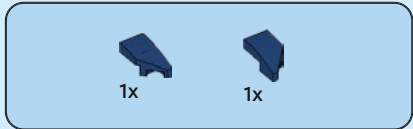
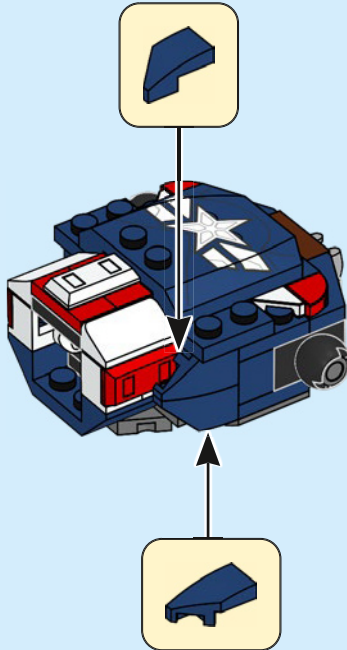

22

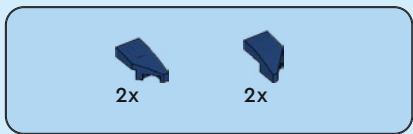
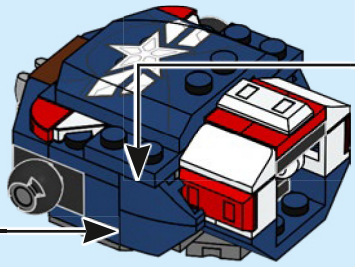

23

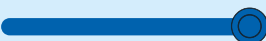
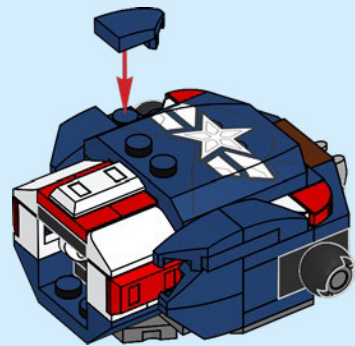

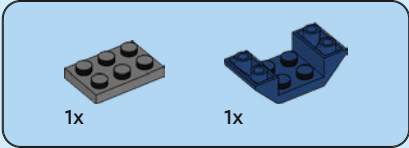

24

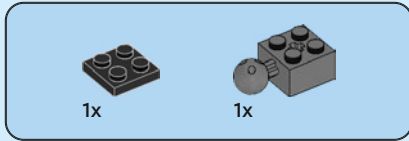
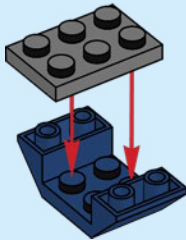

25

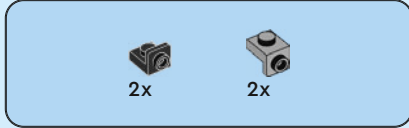
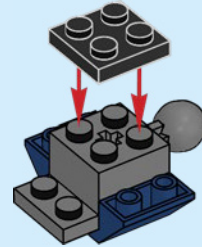

26

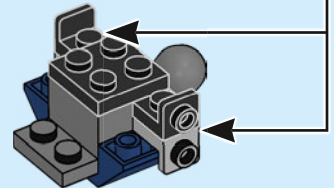
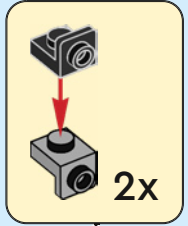



2x

27

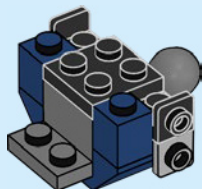

1x

28

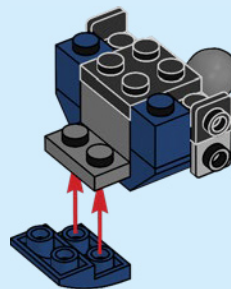

2x

29

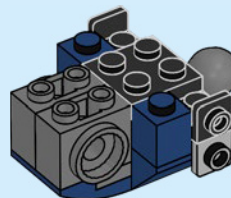



1x

30

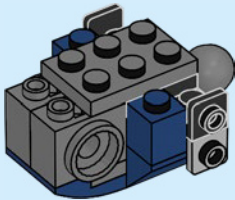

2x

31

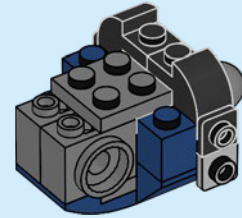

1x



1x



1x



1x

32

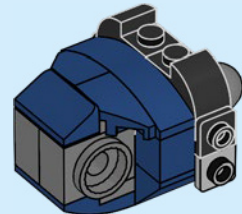



2x

33

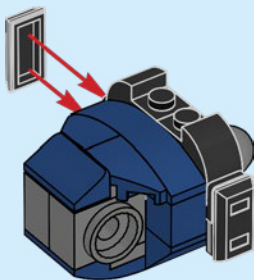

1x

34

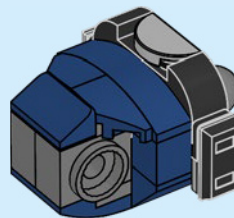



35

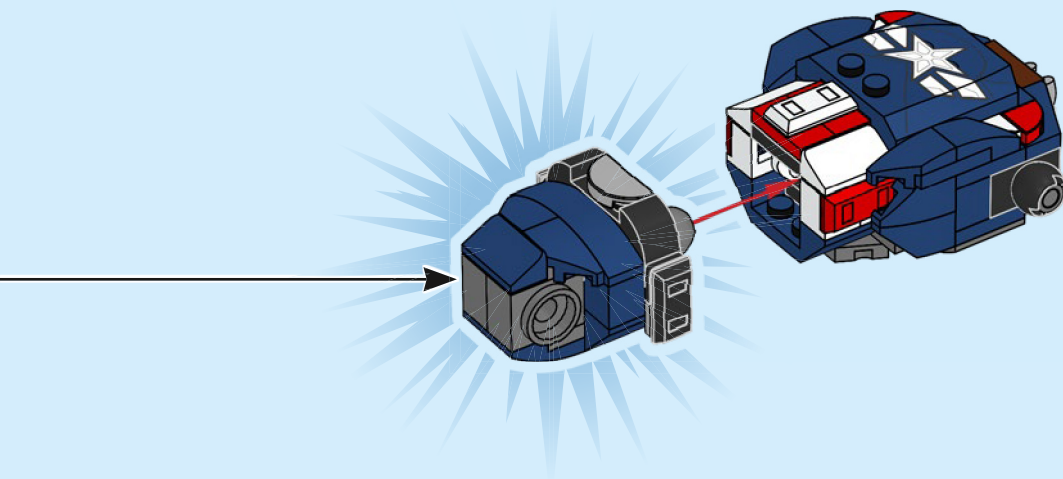

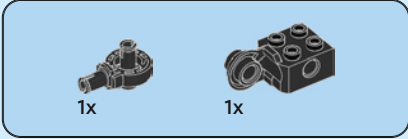
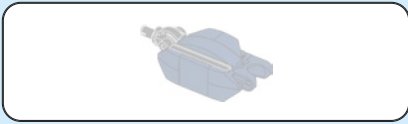

36

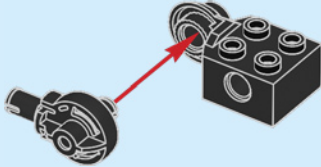

37

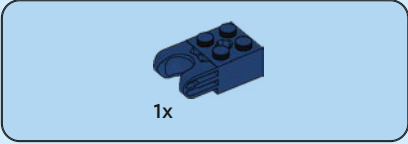
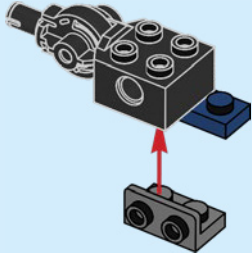

38

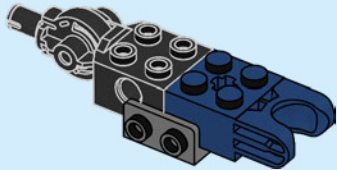

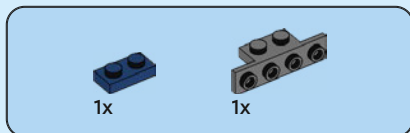

39

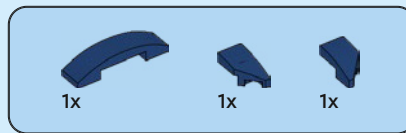
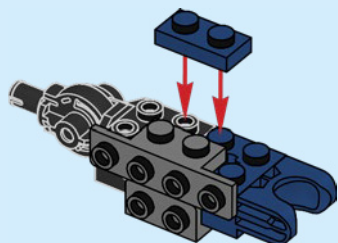

40

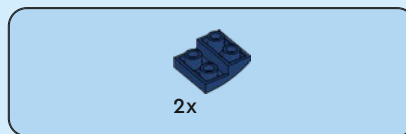
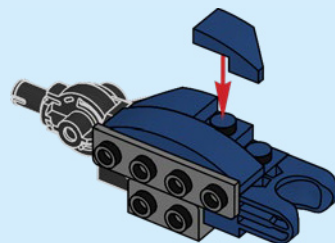

41

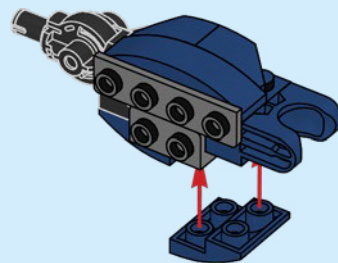

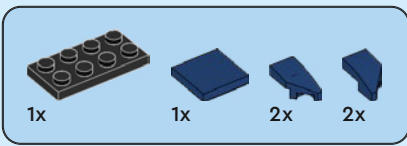

42

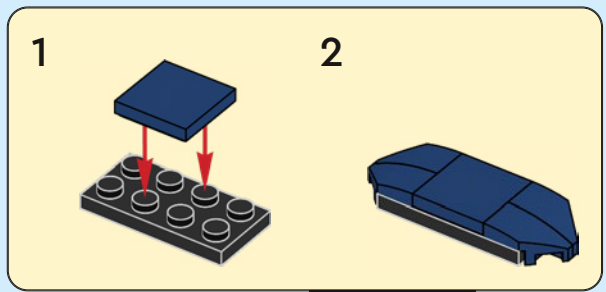

2

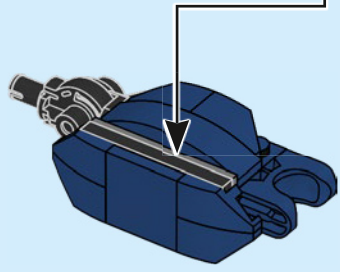
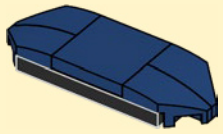

43

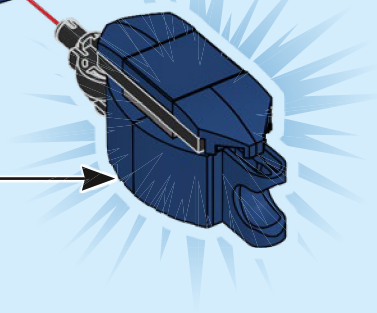
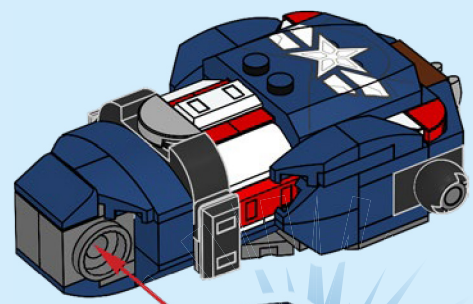

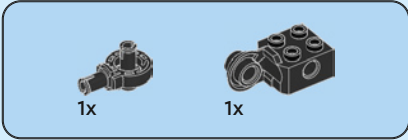
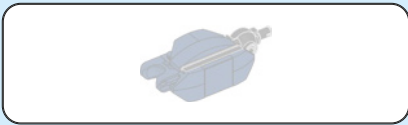

44

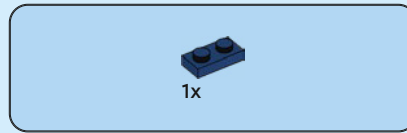
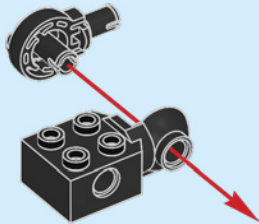

45

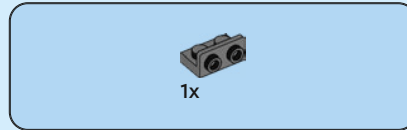
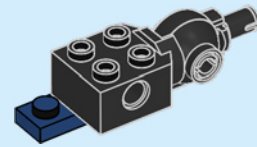

46

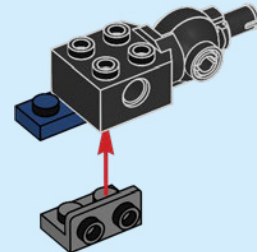

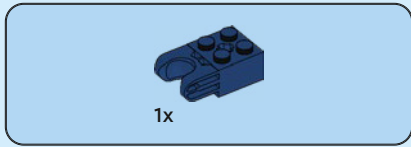

47

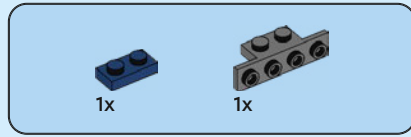
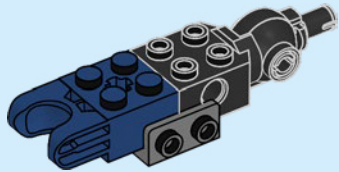

48

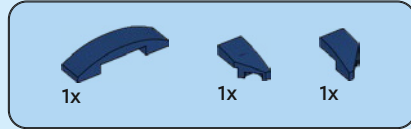
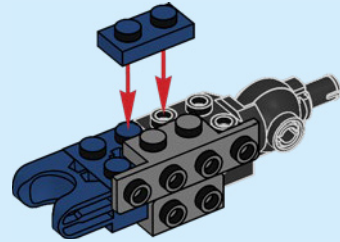

49

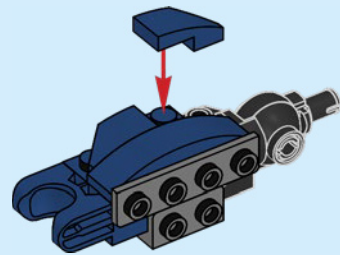



50

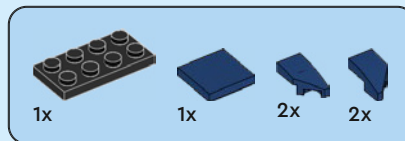
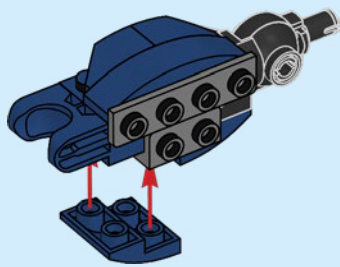

51

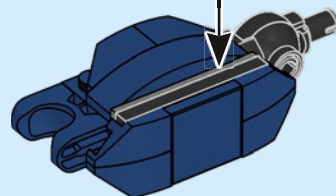
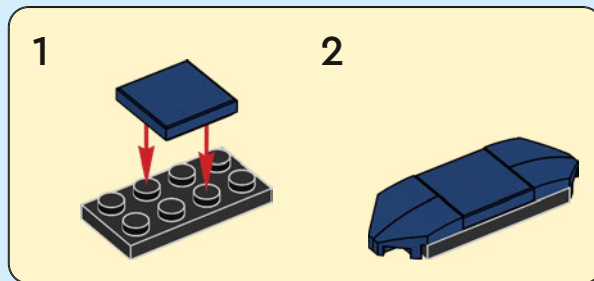

52

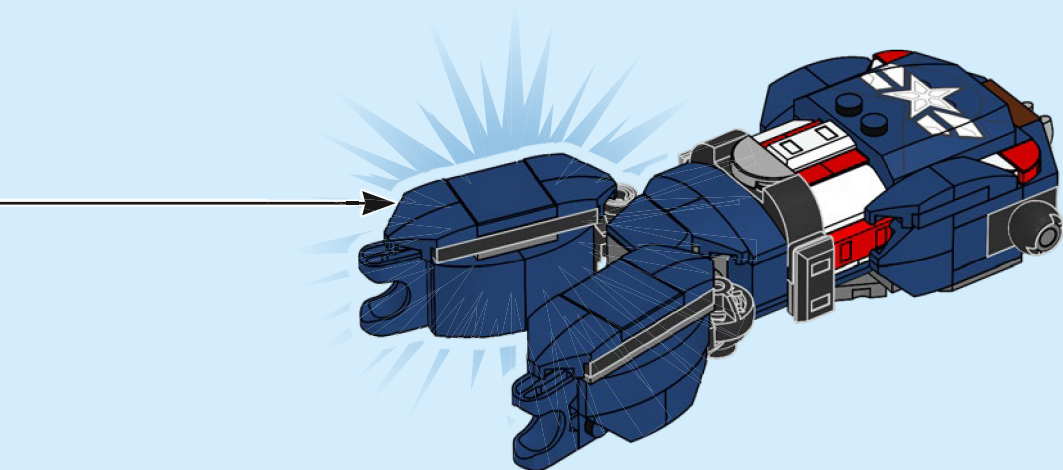



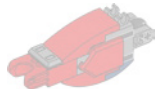

2x



1x



1x

53

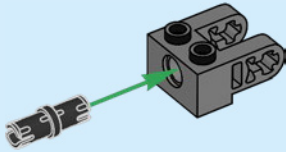

1x

54

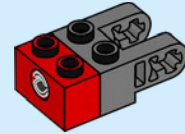

2x

55

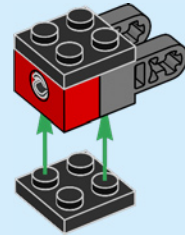



1x

56

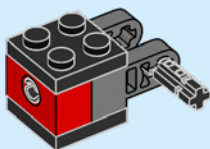

1x

57

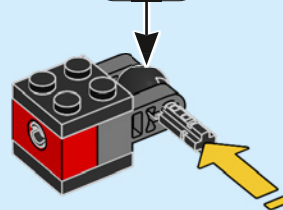

2x

58

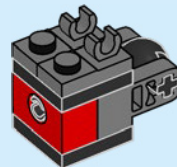

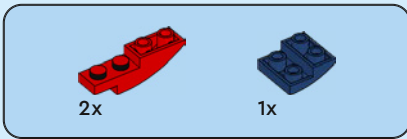

59

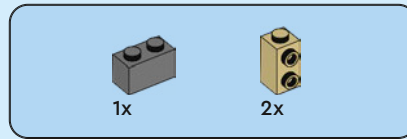
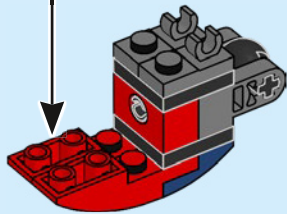
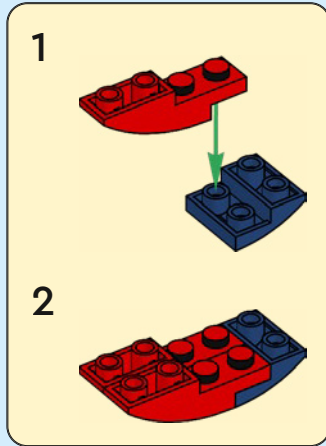

60

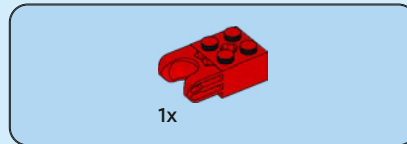
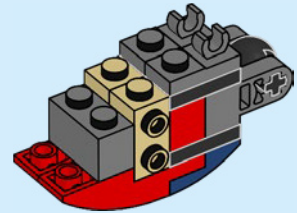

61

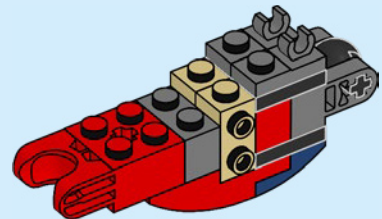

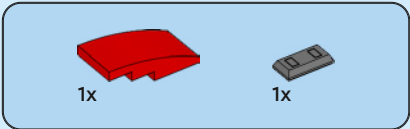

62

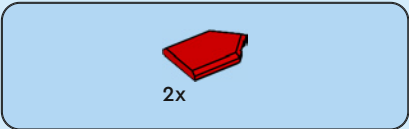
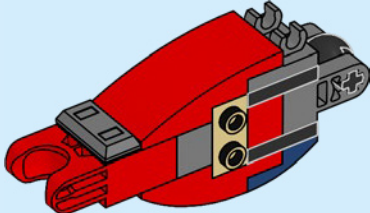

63

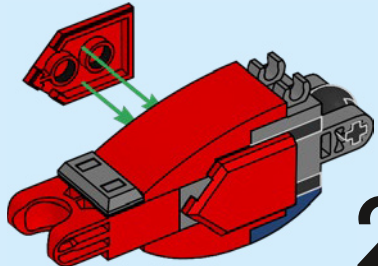

2x



64

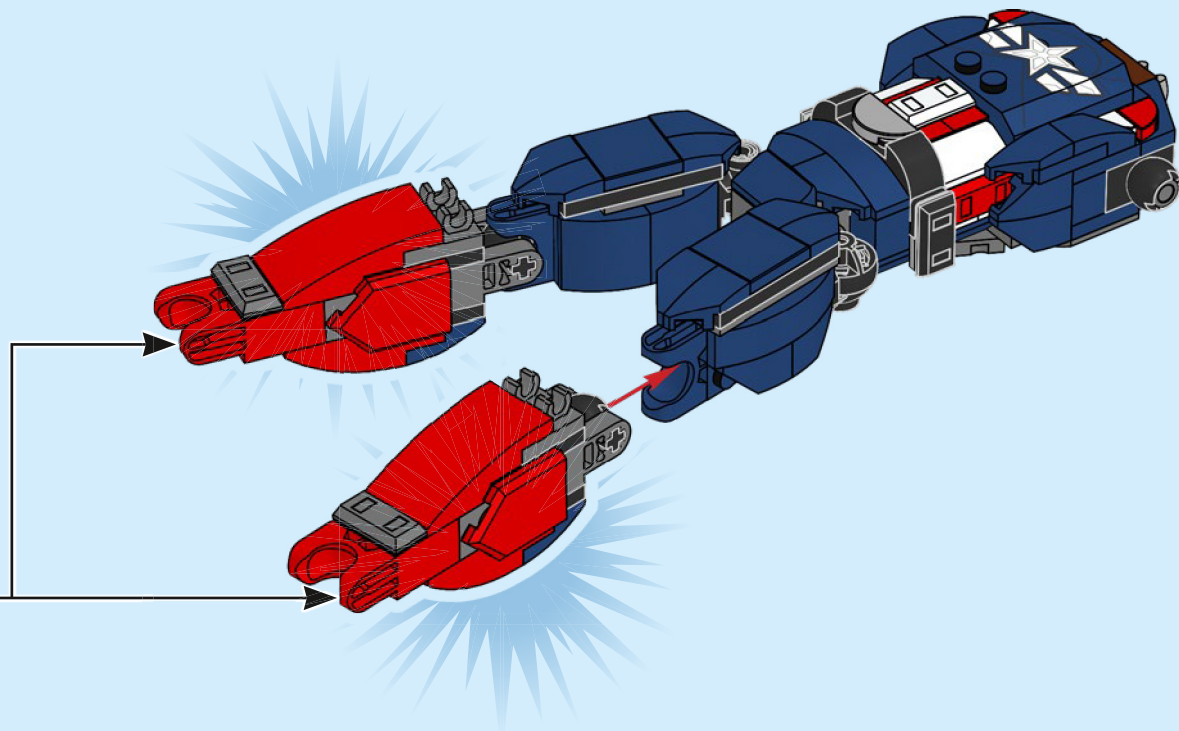

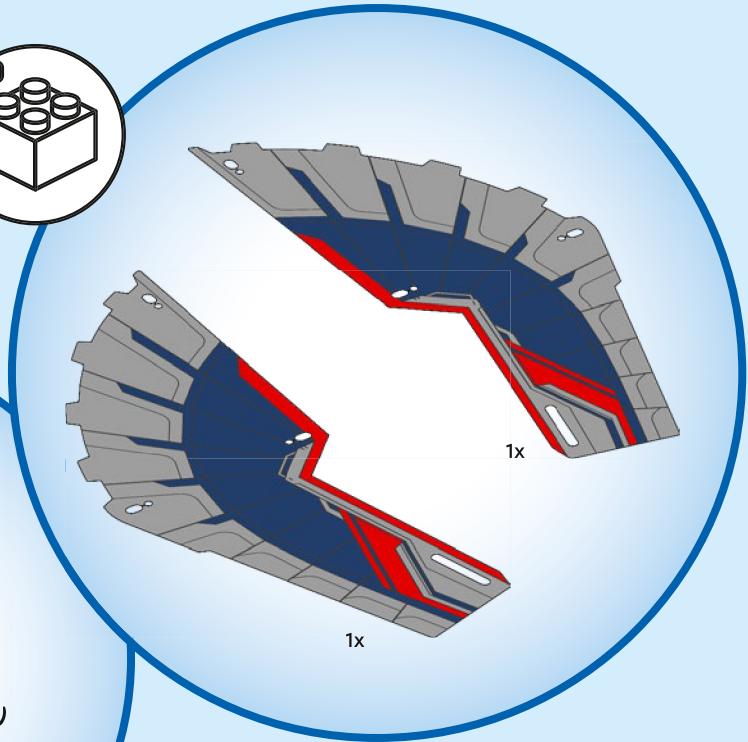
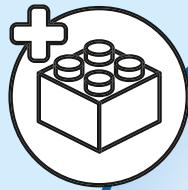

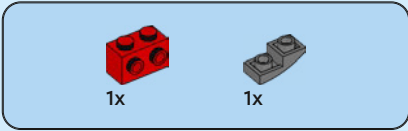
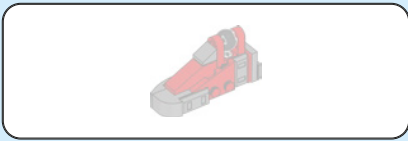

65

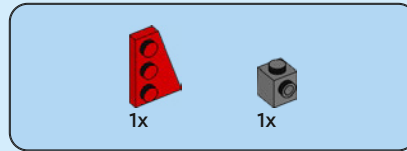
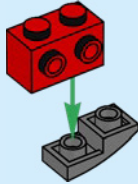

66

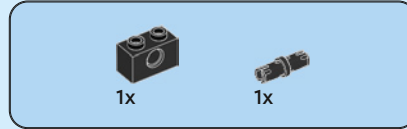
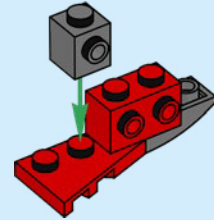

67

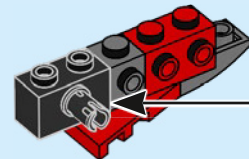
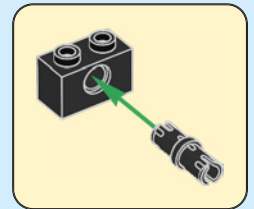



68

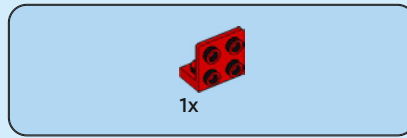
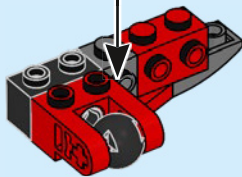
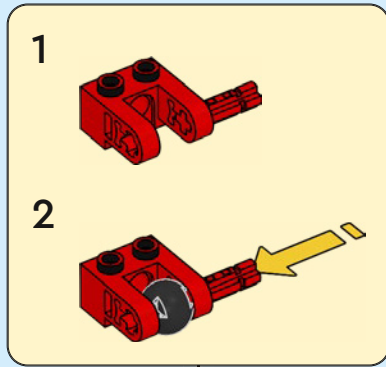

69

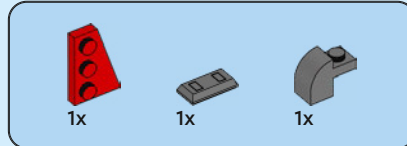
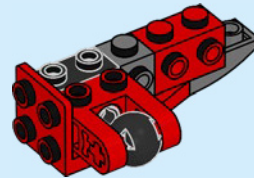

70

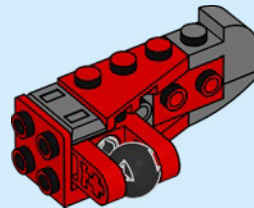



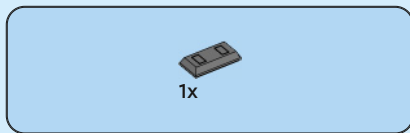

71

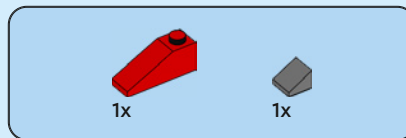
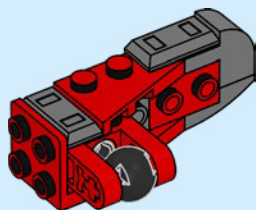

72

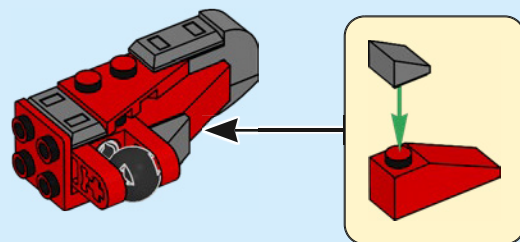

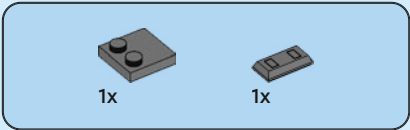

73

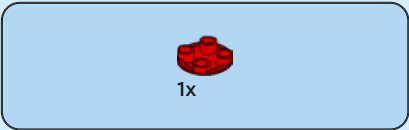
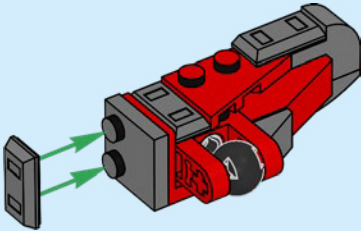

74

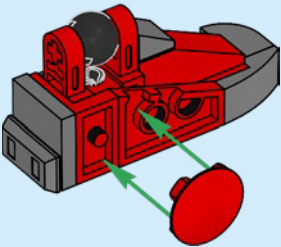

75

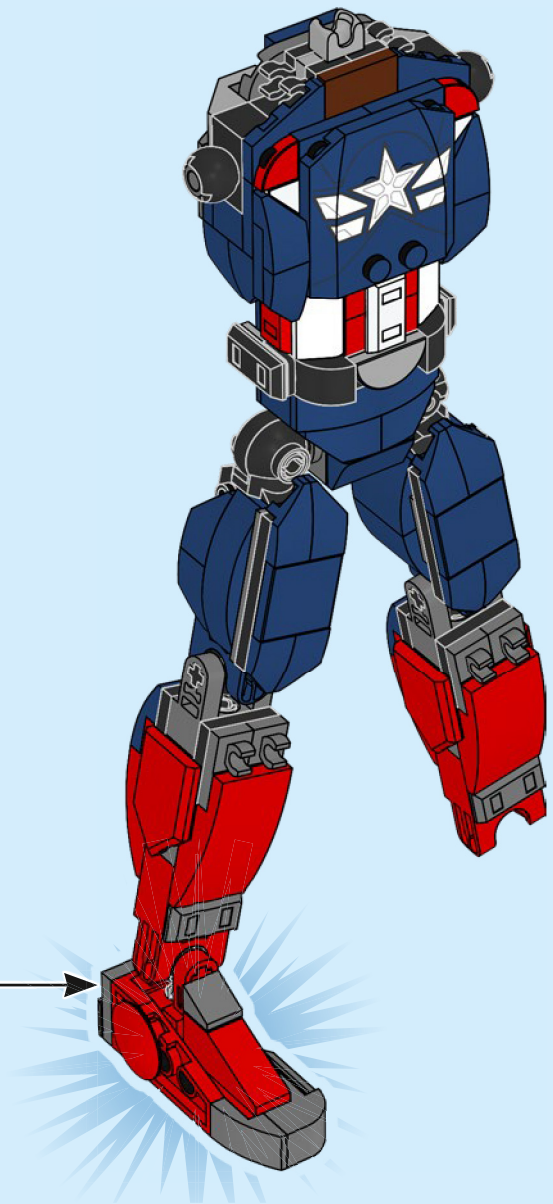

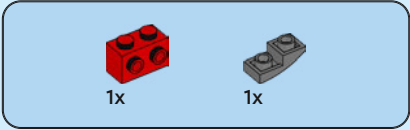
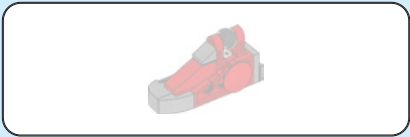

76

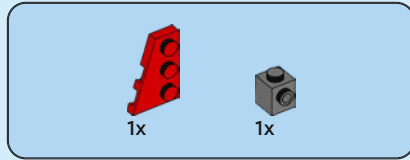
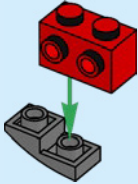

77

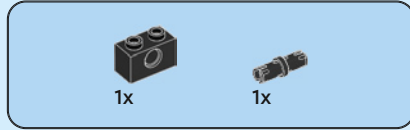
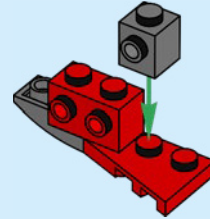

78

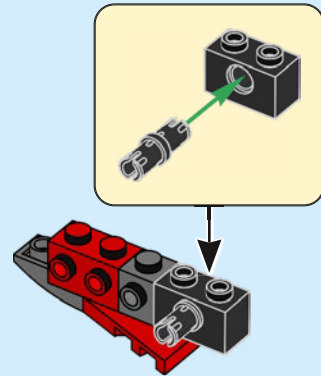

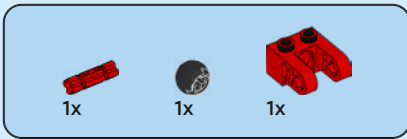

79

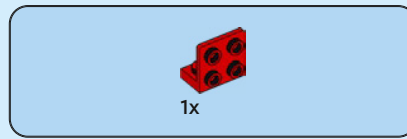
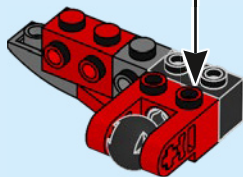
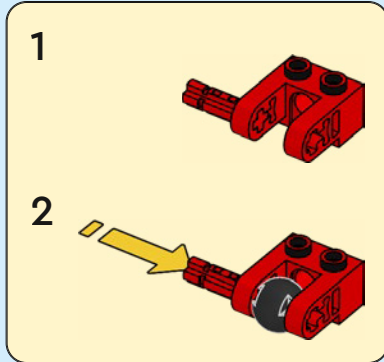

80

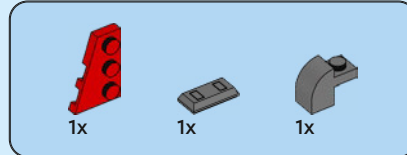
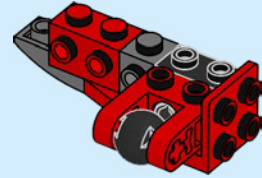

81

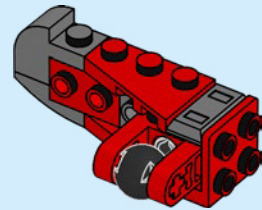



1x

82

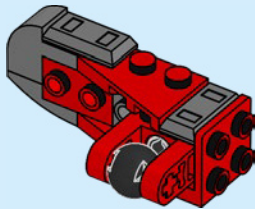

1x



1x

83

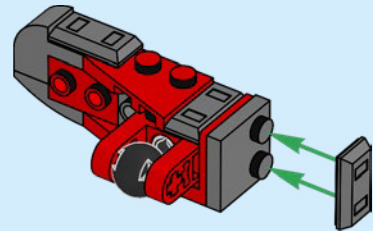

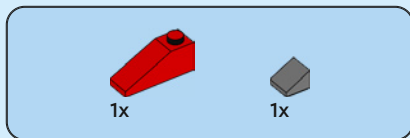

84

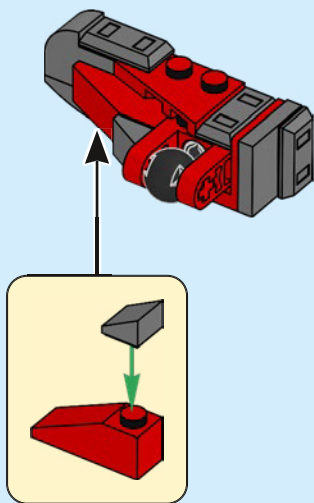

85

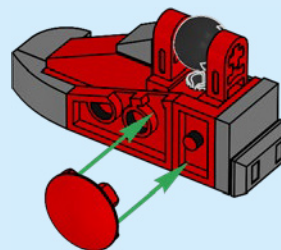

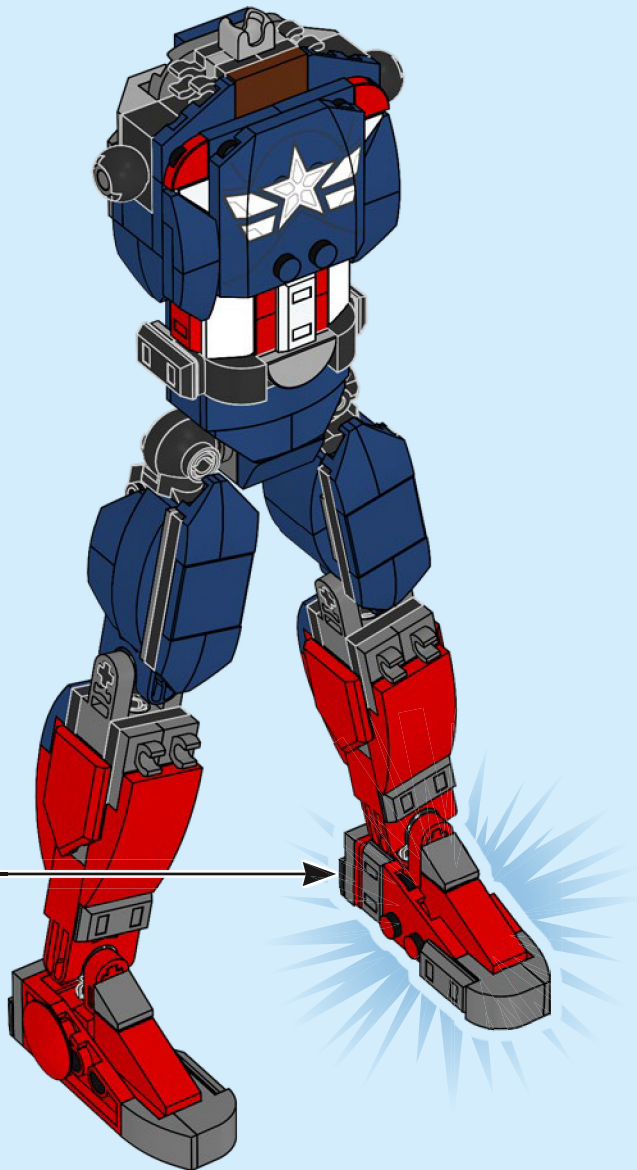



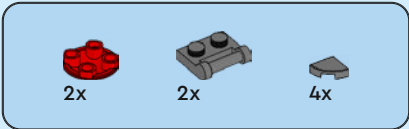

87

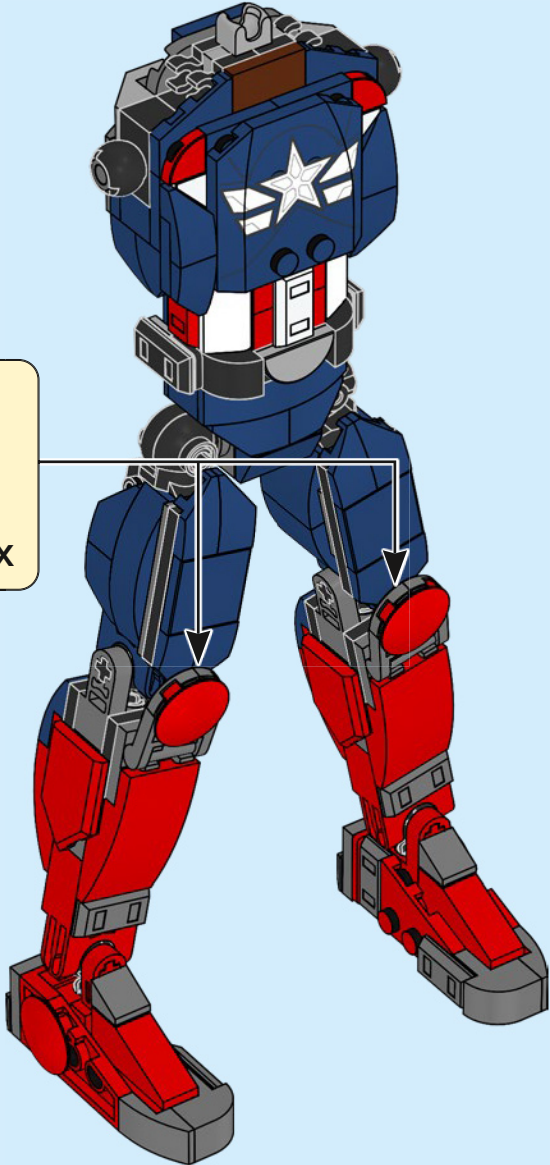
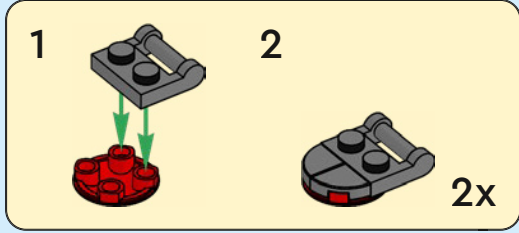



1x



1x

88

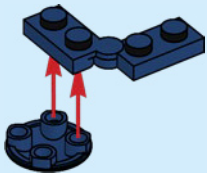

2x

89

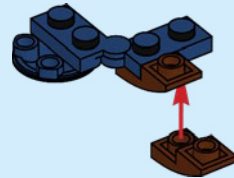

1x



1x

90

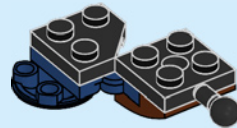



1x

91

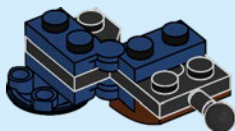

1x

92

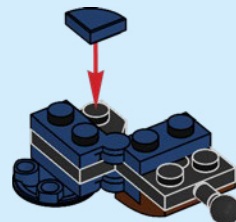

1x



1x

93

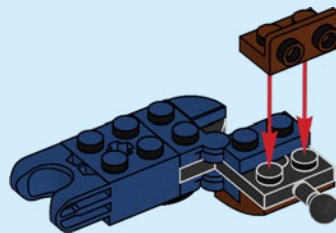

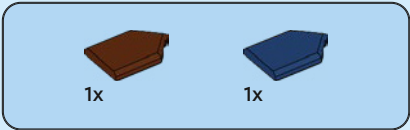

94

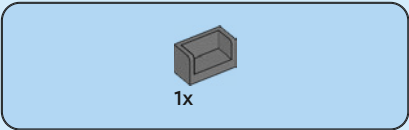
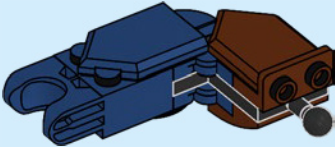

95



96

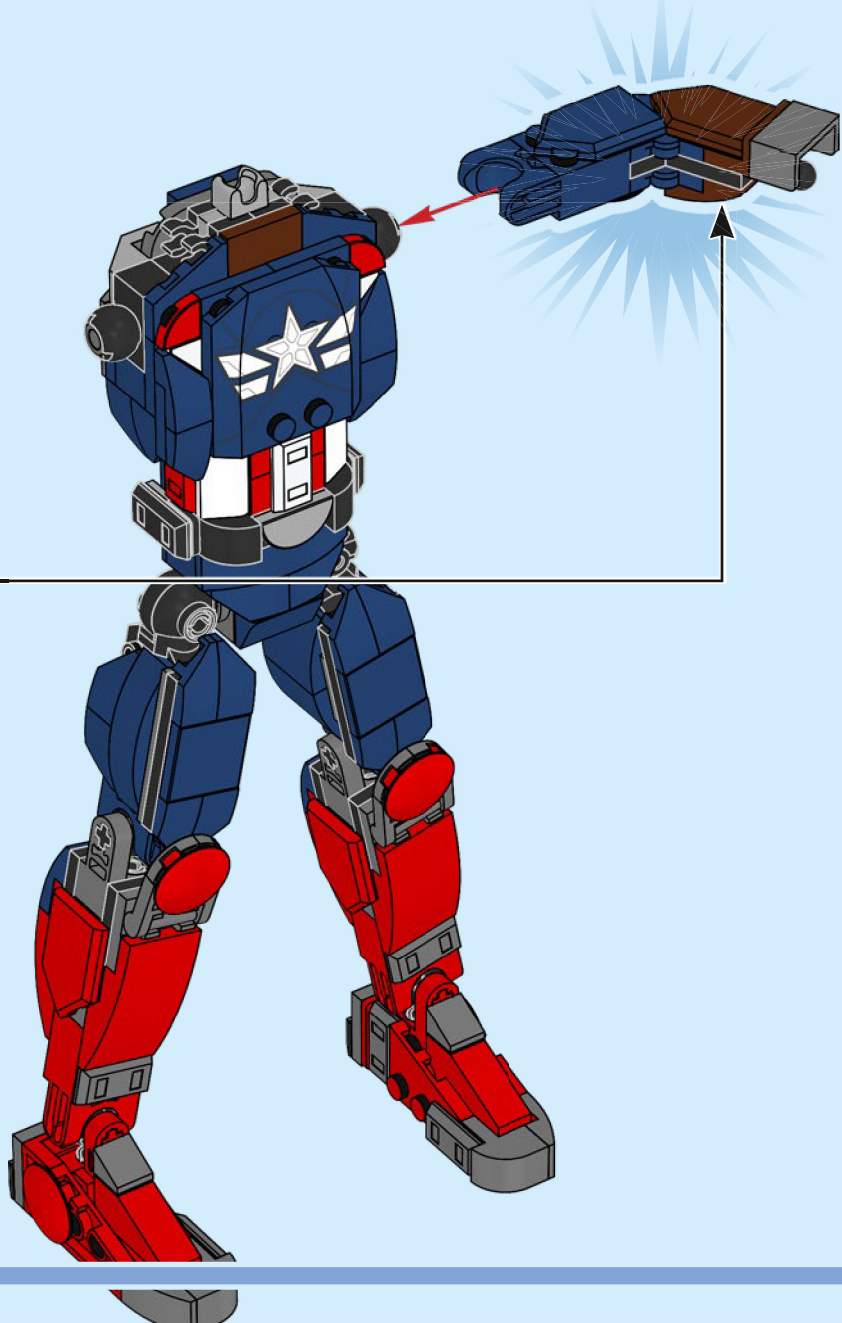

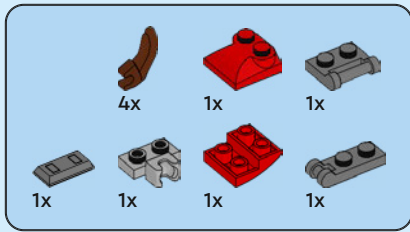

97

1

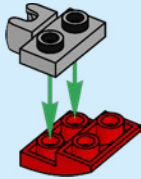

2



3

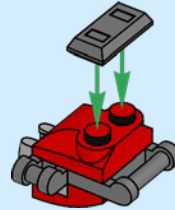

4

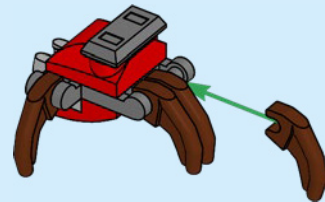

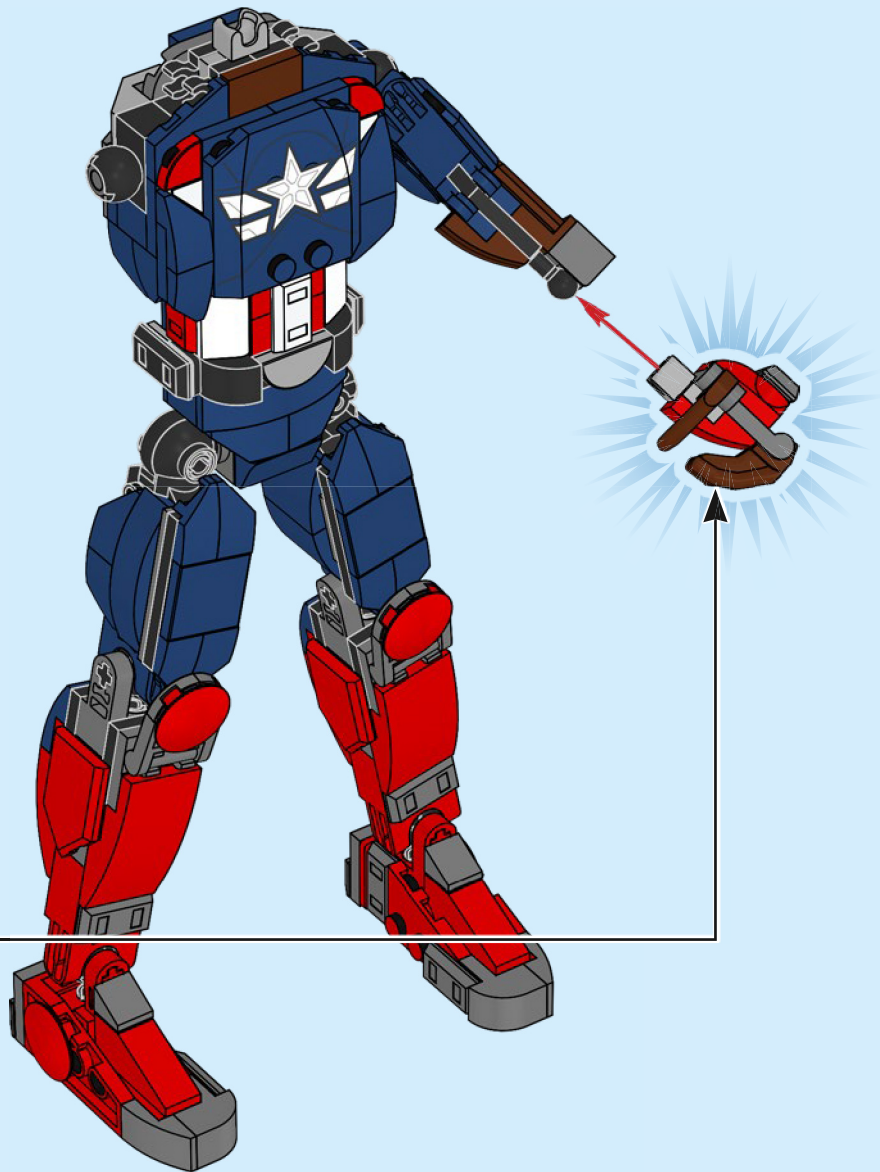

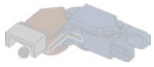

1x



1x

98

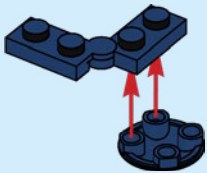

2x

99

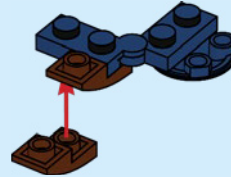

1x



1x

100

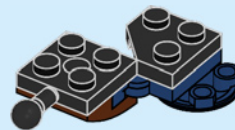





1x

# 101

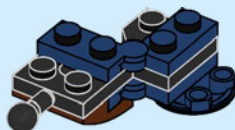

1x

# 102

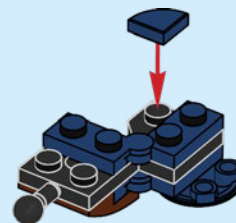

1x



1x

# 103

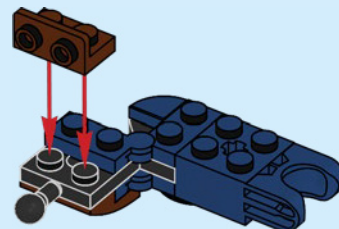

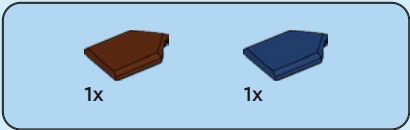

104

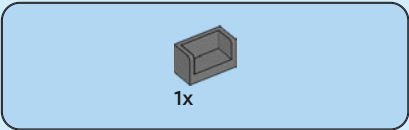
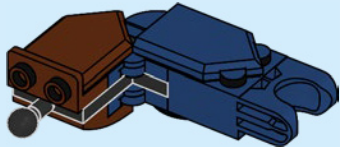

105



106

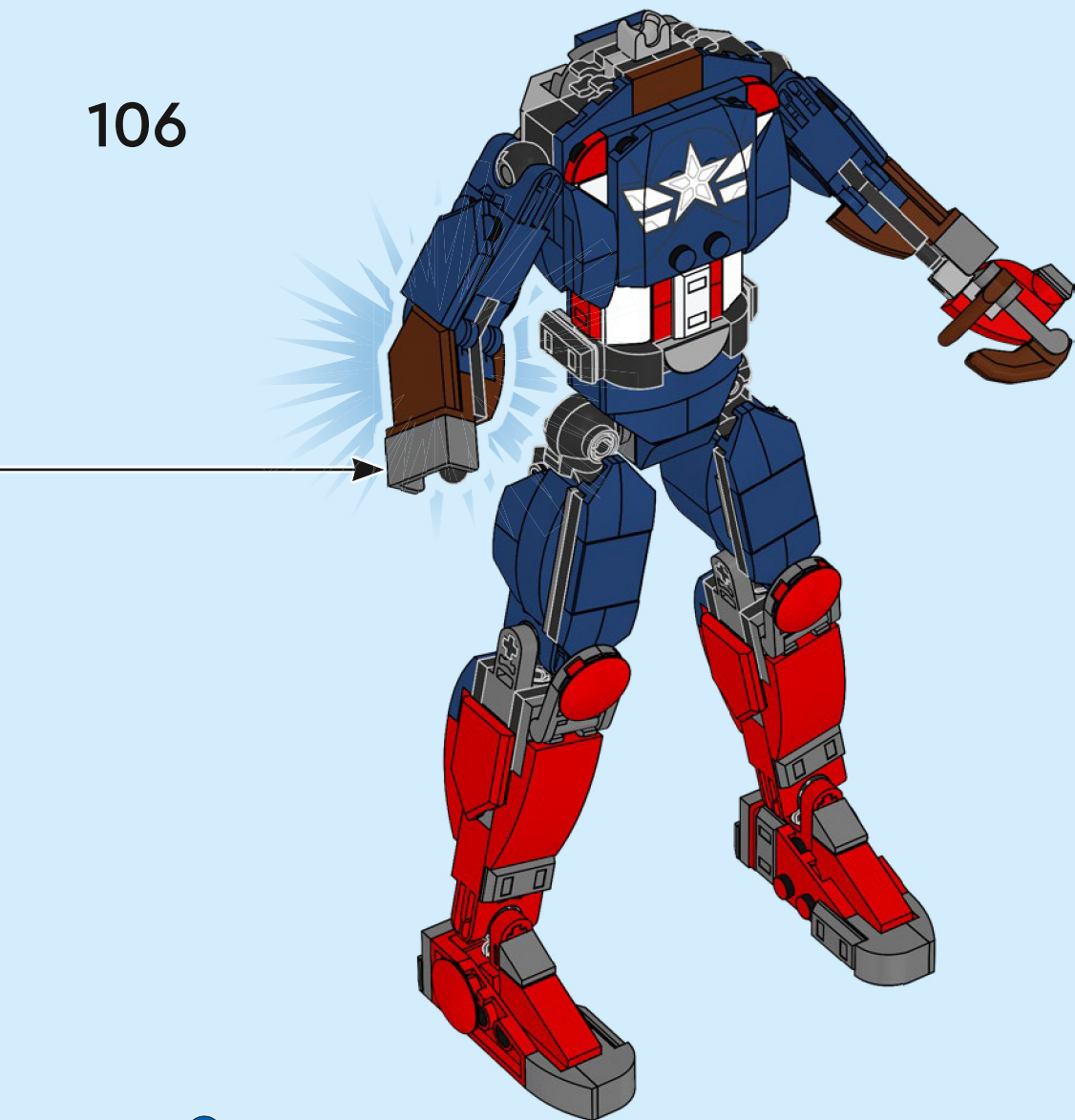

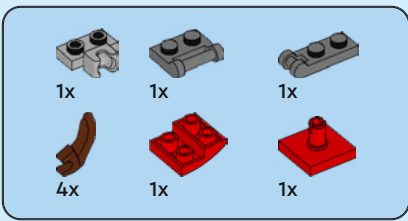

107

1

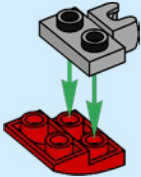

2



3

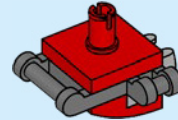

4

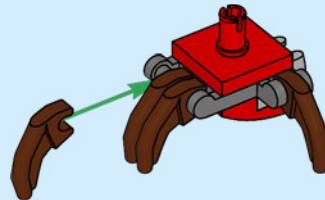

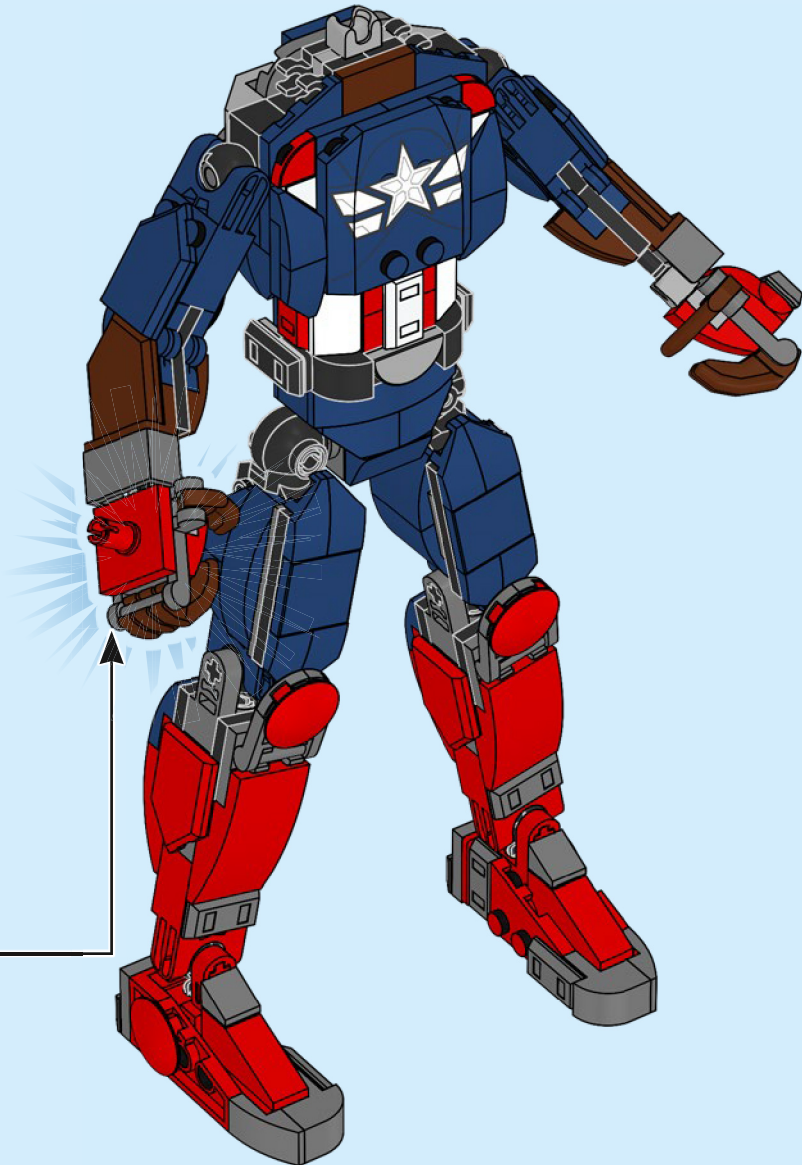



2x

108

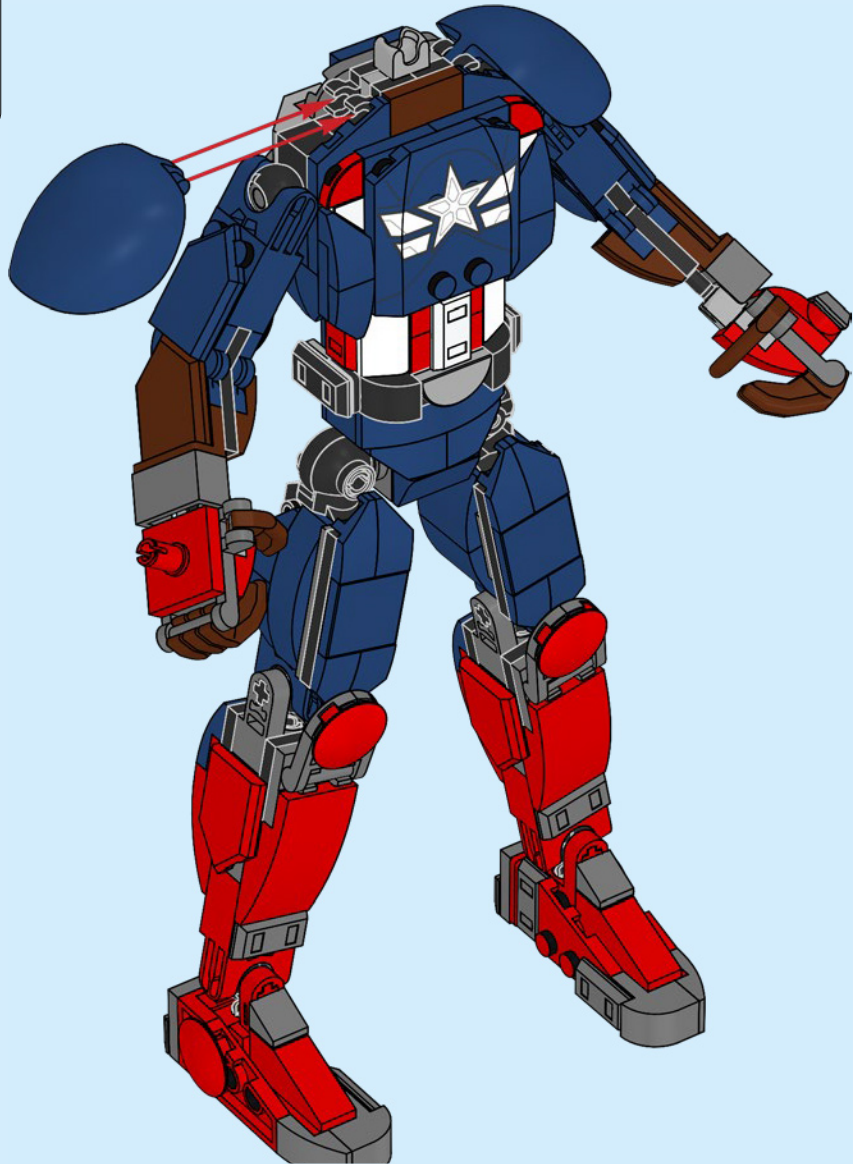



109

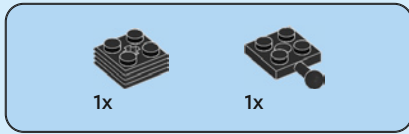
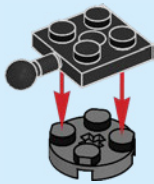

110

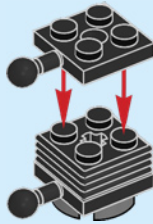

111

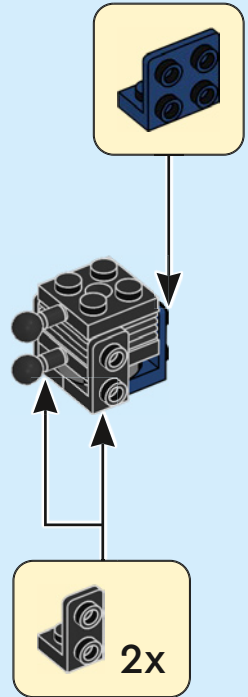

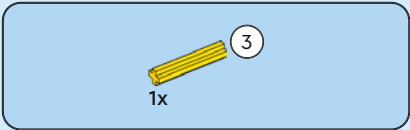

112

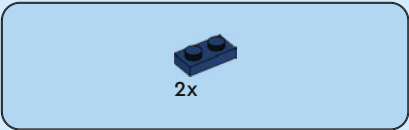
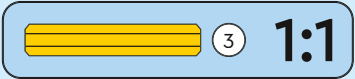
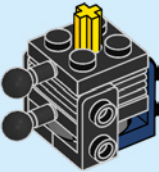

113

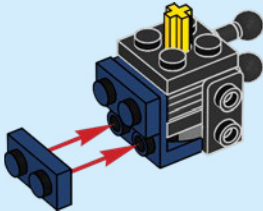



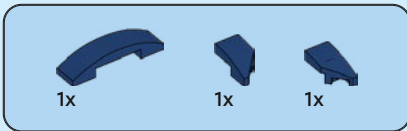

114

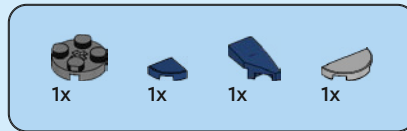
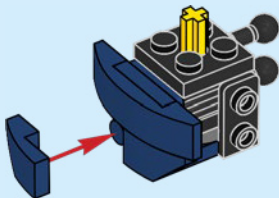

115

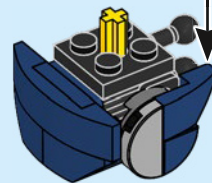
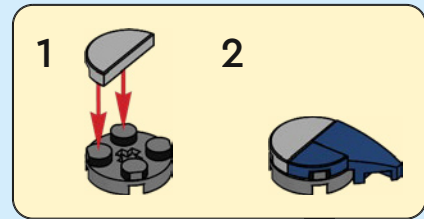

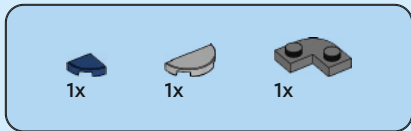

116

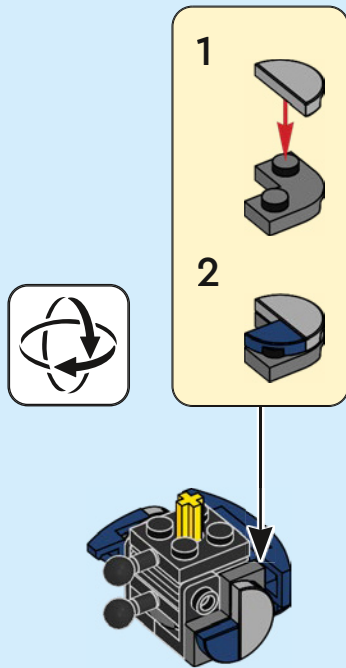

117

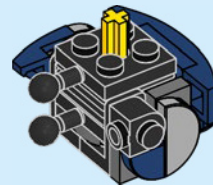

118

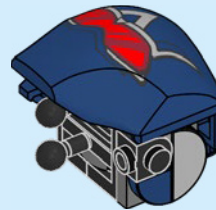

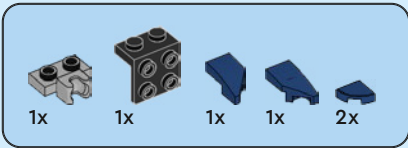

119

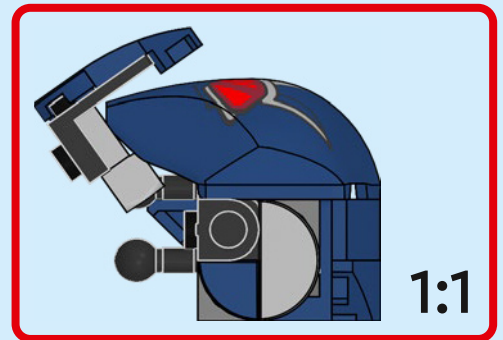
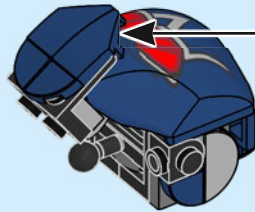
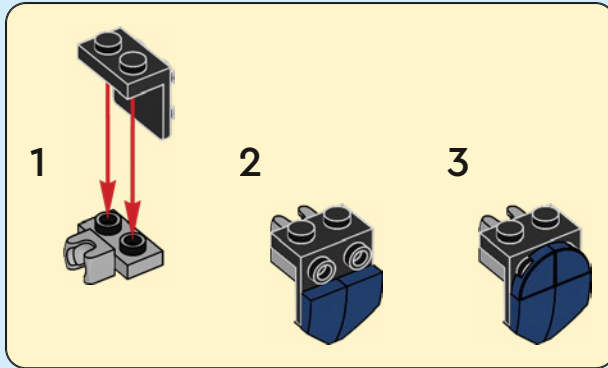



1x

# 120

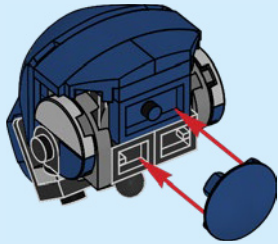

1x



1x

# 121

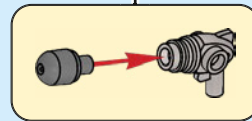

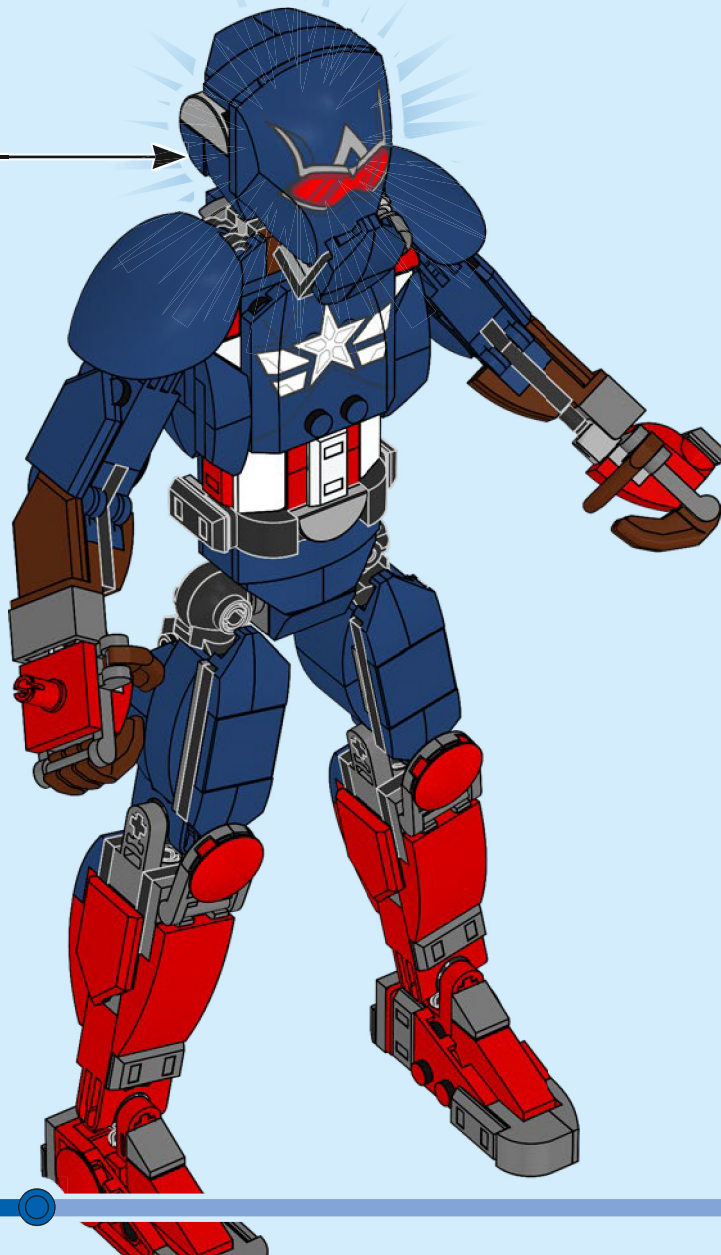

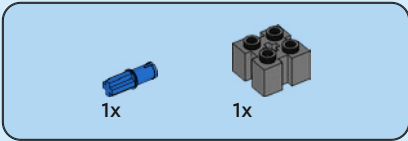

123

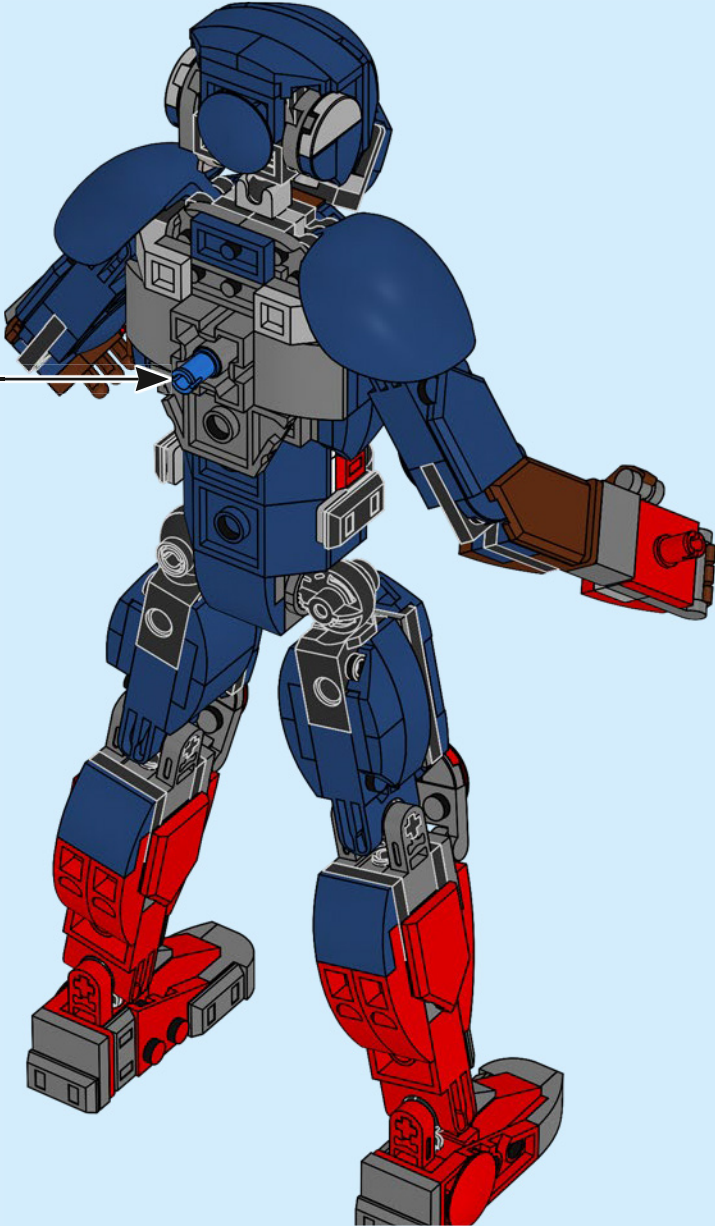
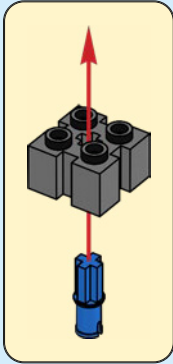



1x

124

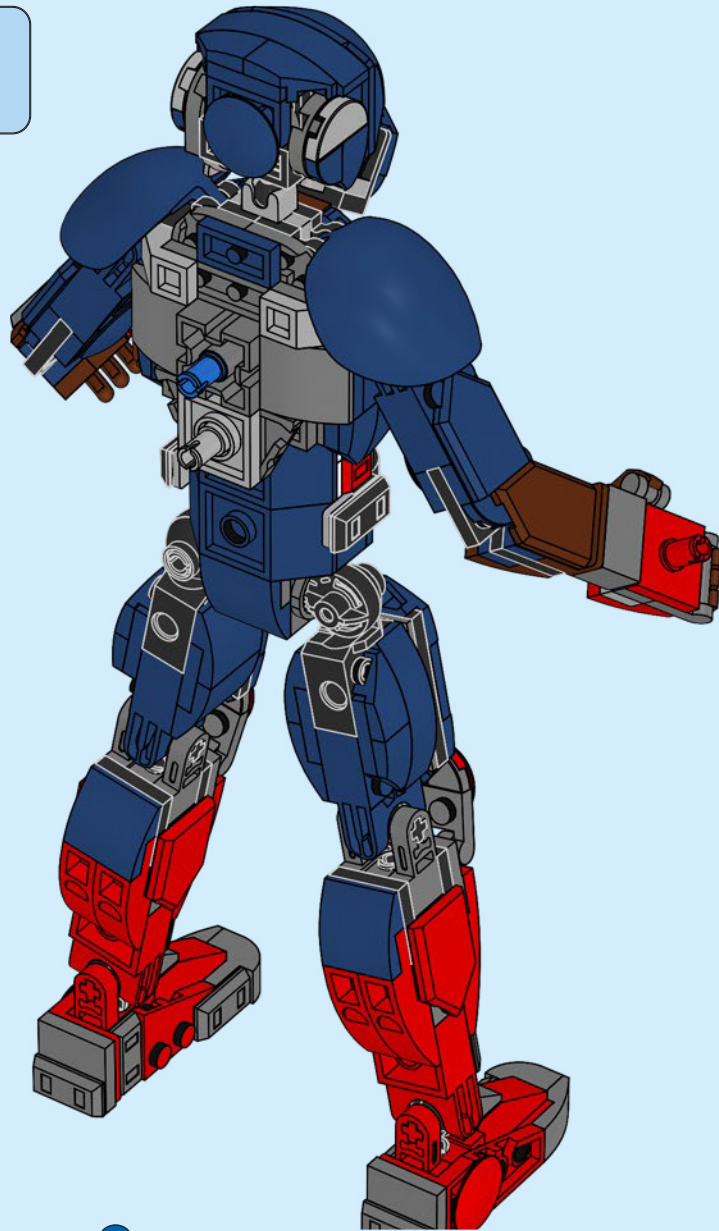

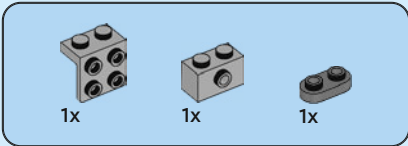

# 125

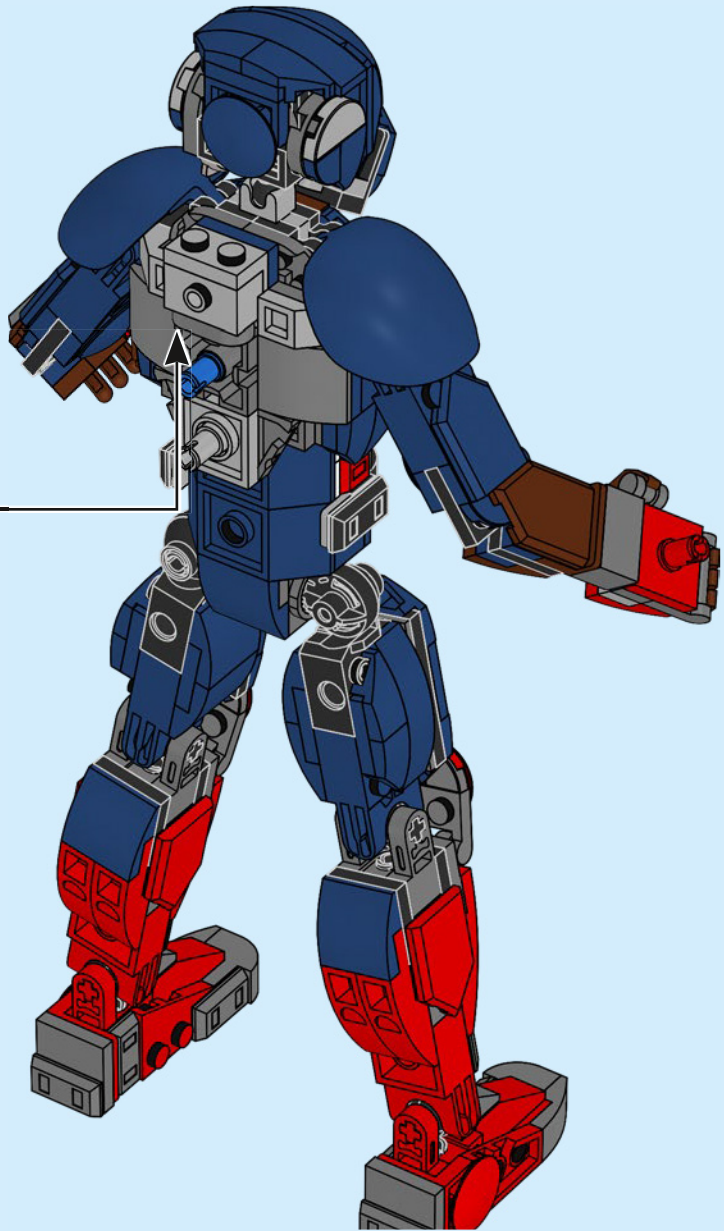
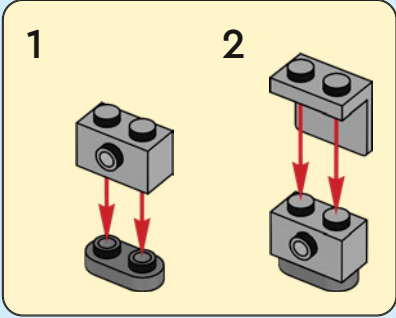





1x



1x

126

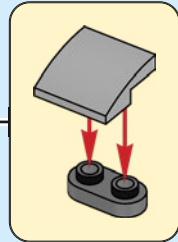
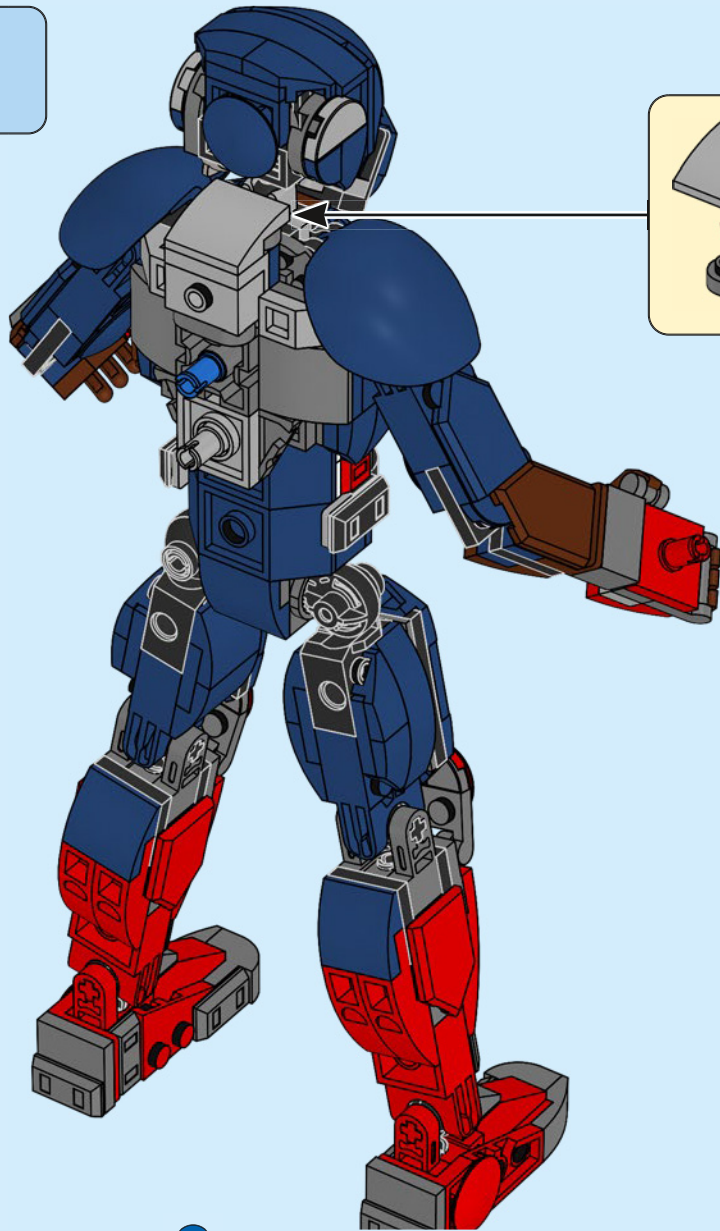

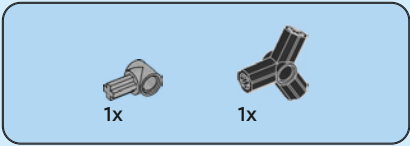

127

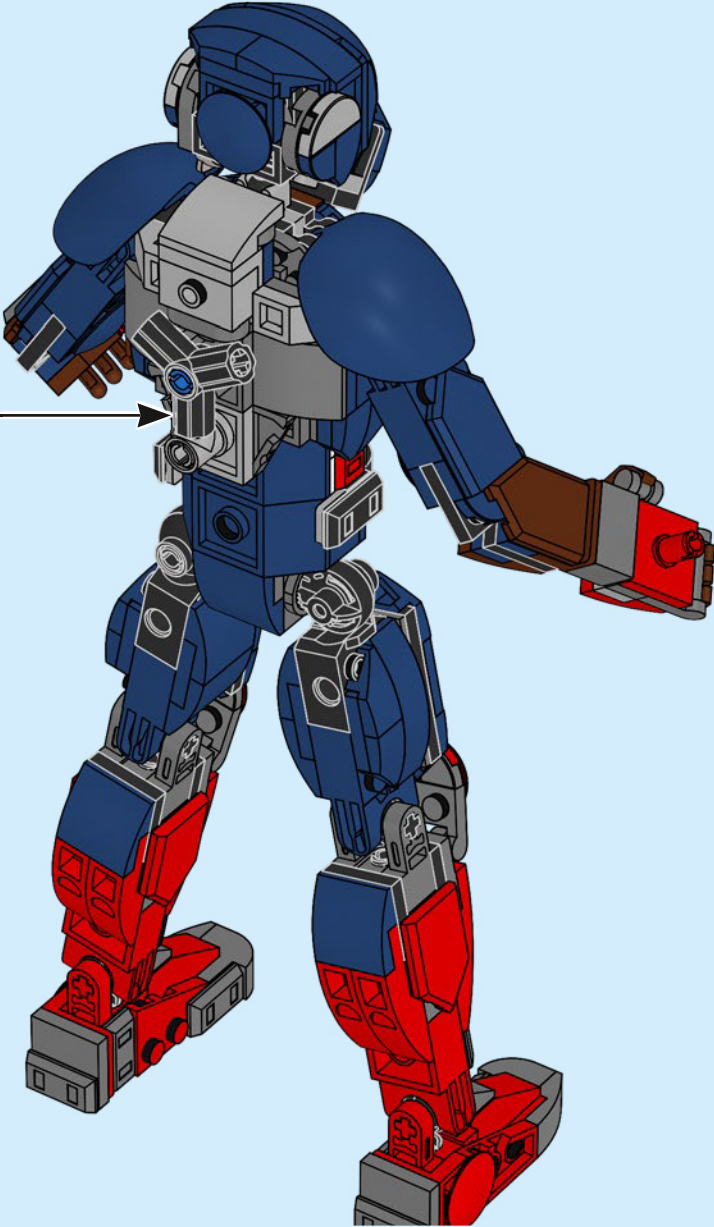
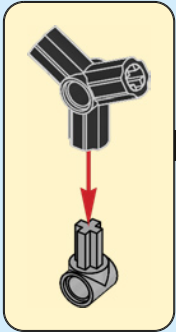

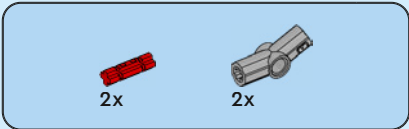

128

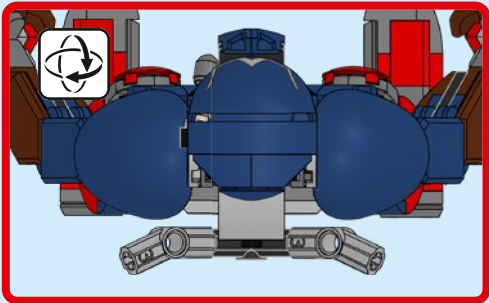
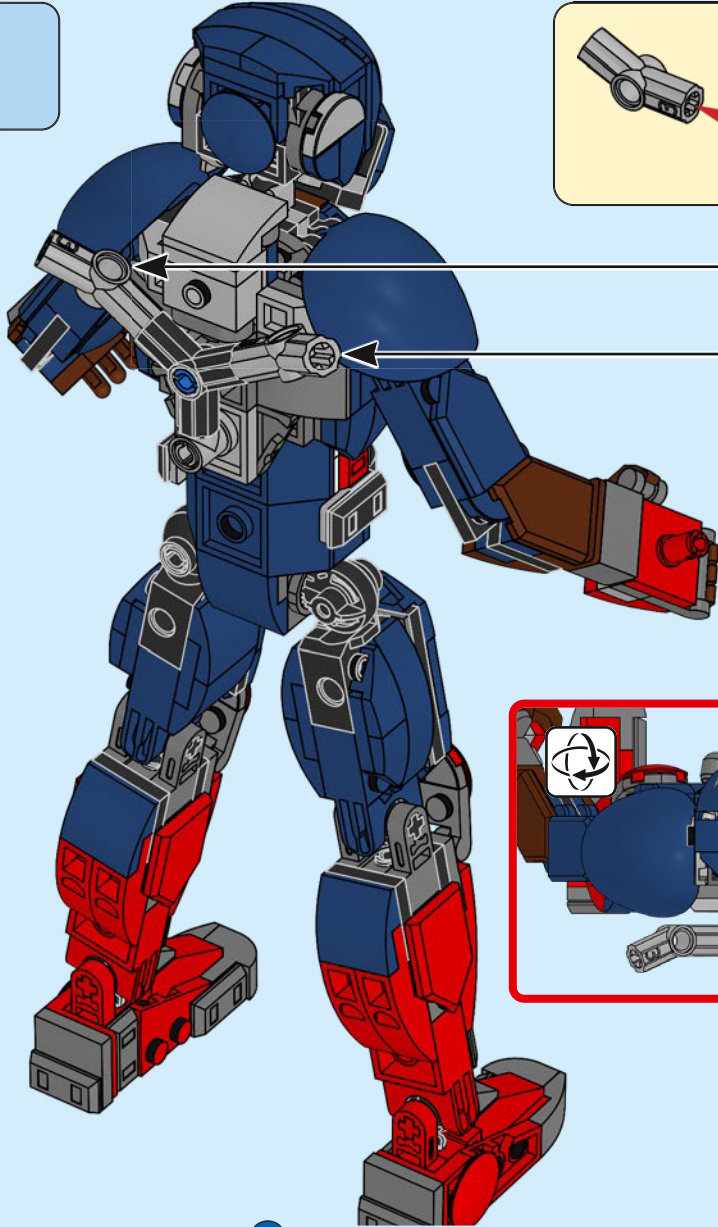
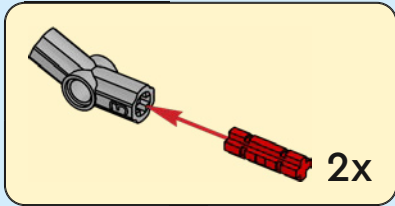

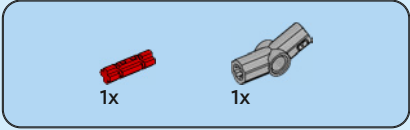
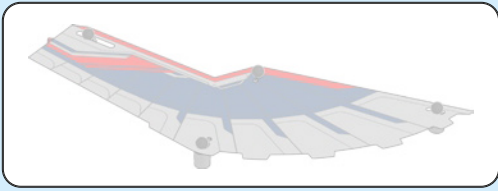

129

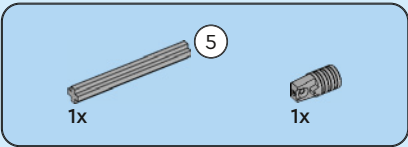
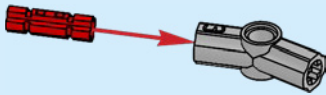

130

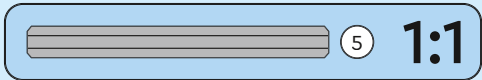
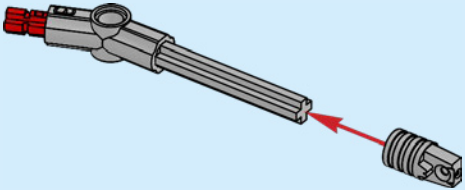

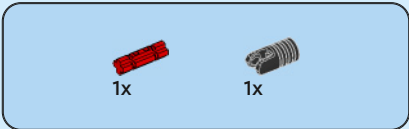

131

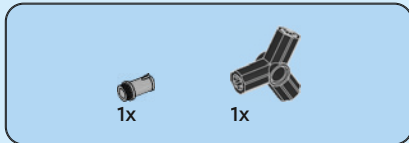
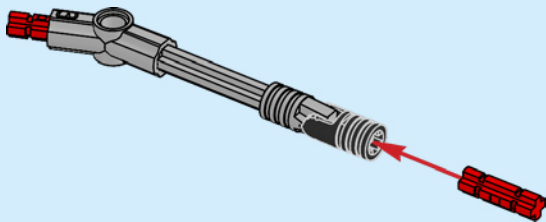

132

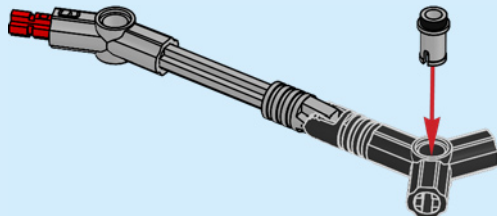

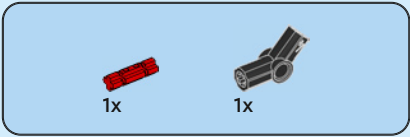

# 133

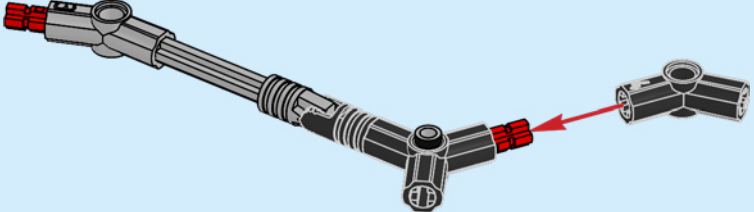

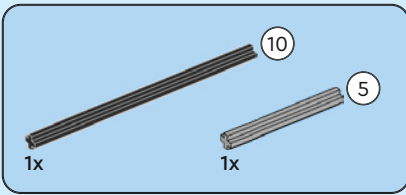

134

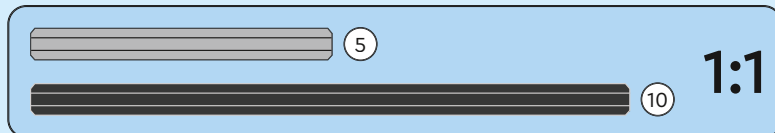
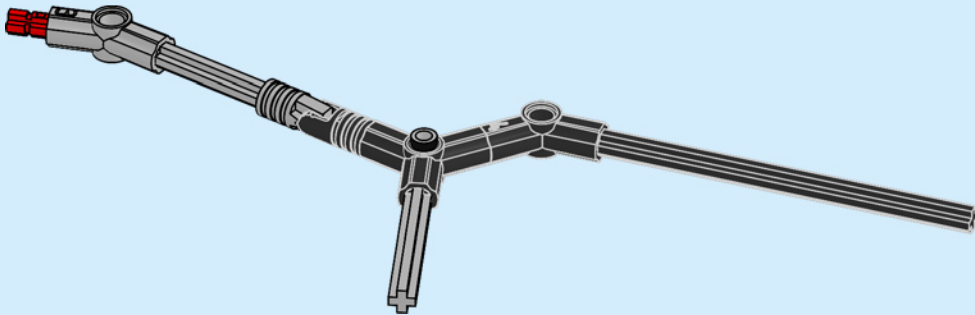



2x

135

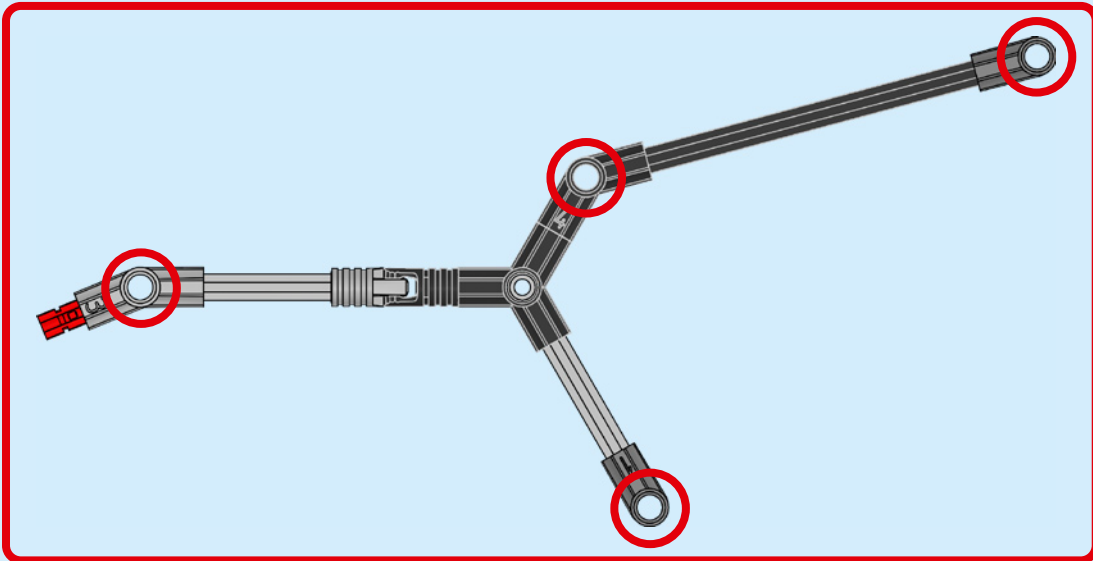
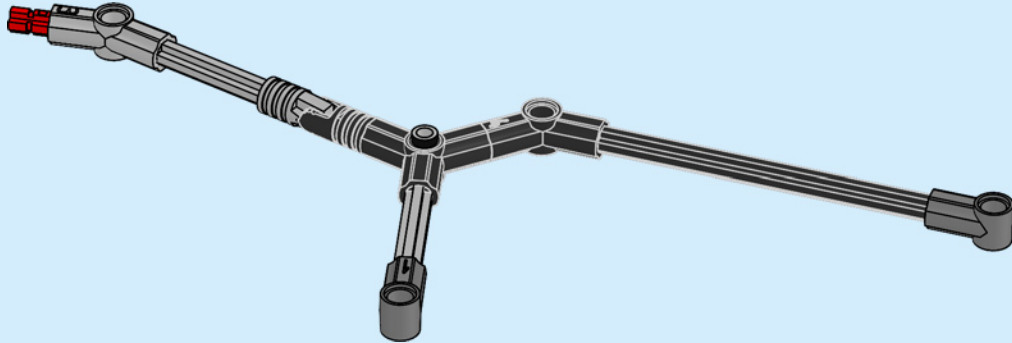





4x

136

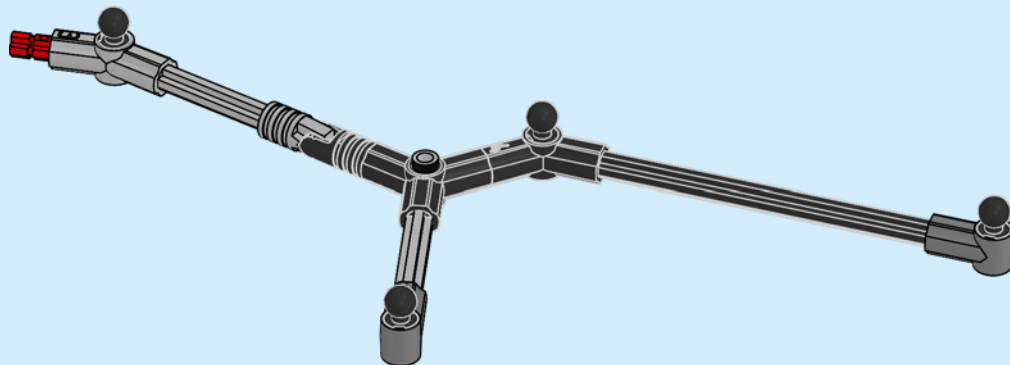

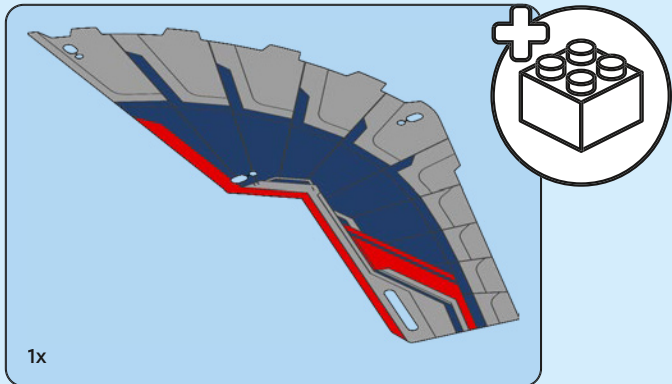

137

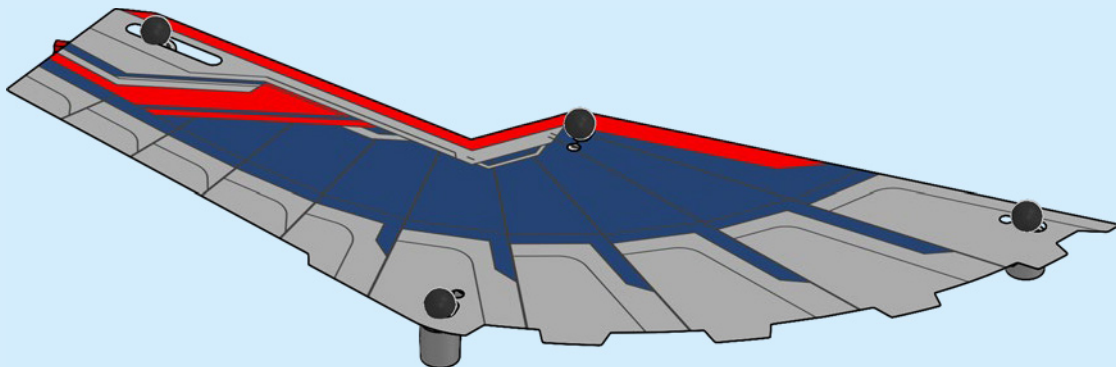

138

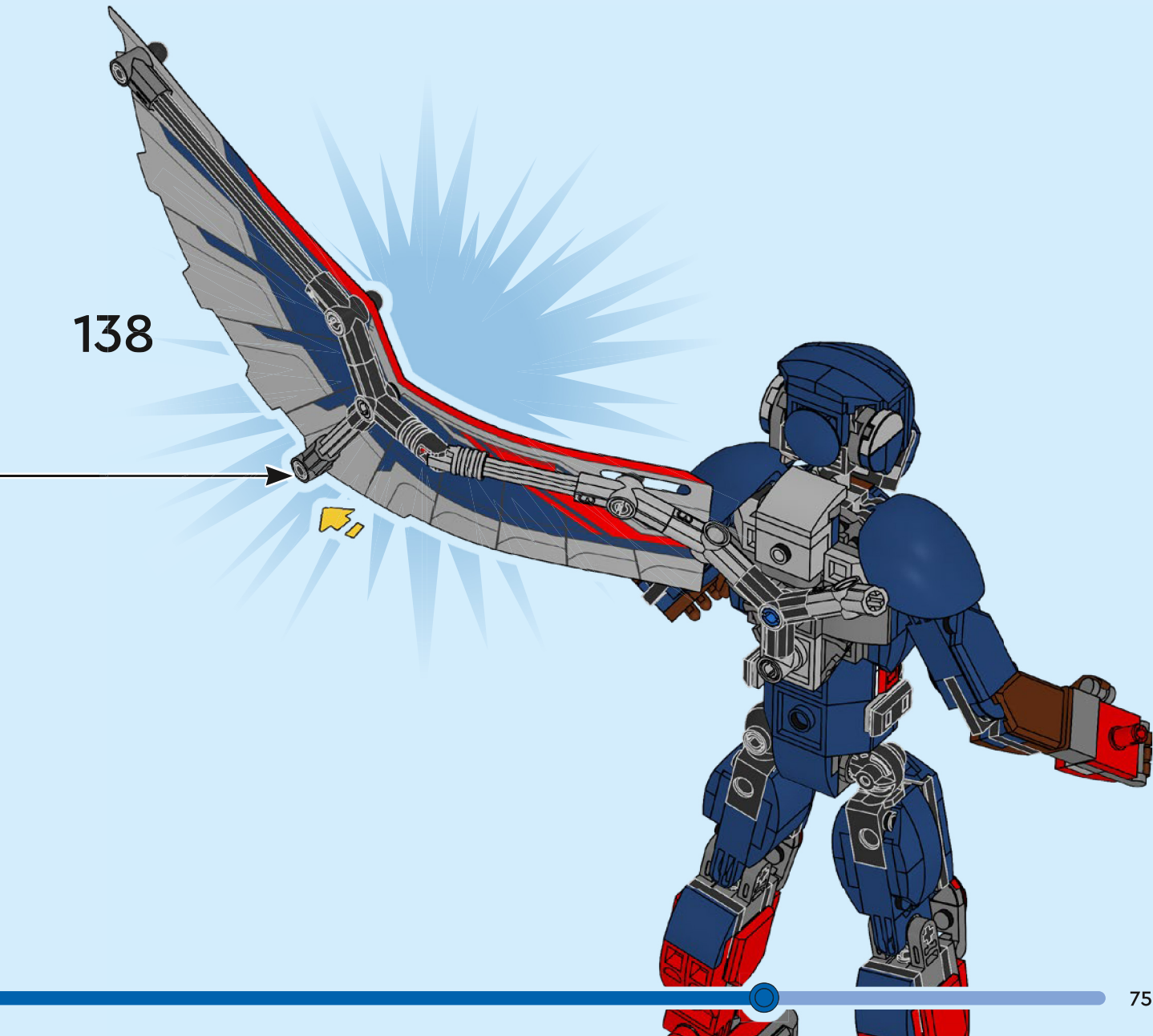

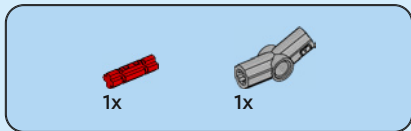
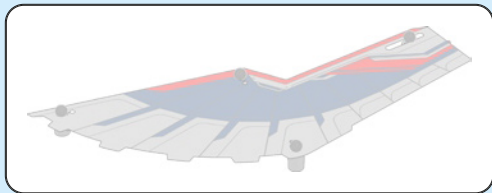

139

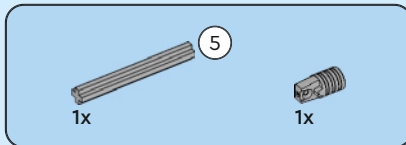
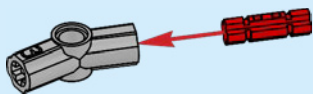

140

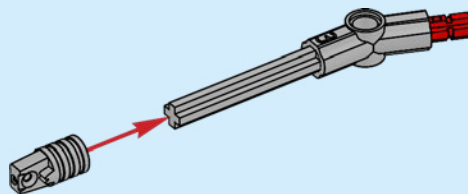

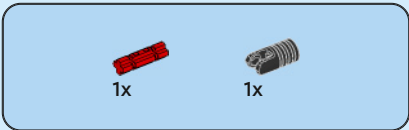

141

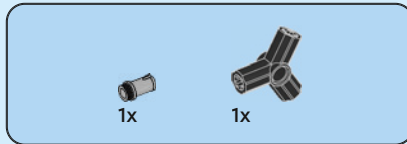
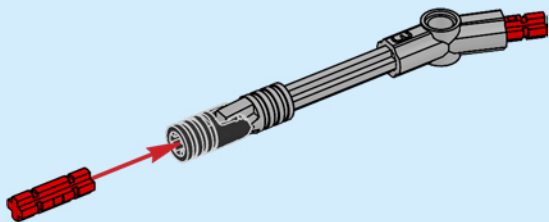

142

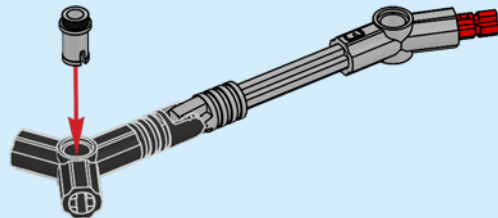

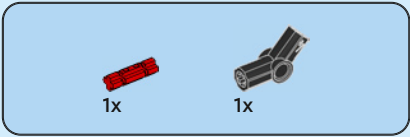

143

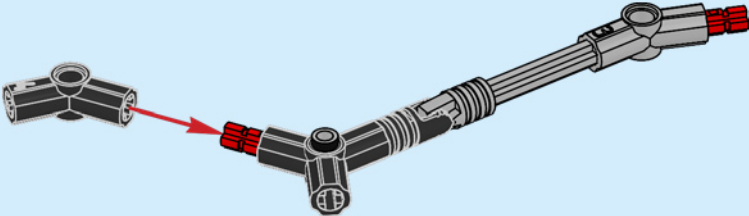

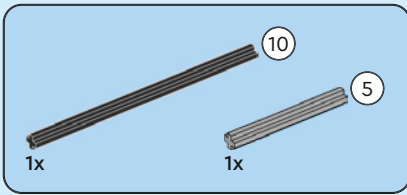

144

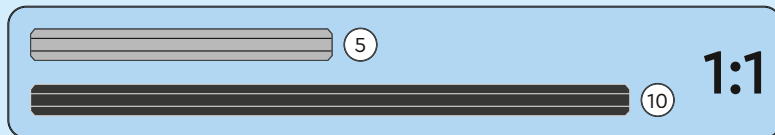
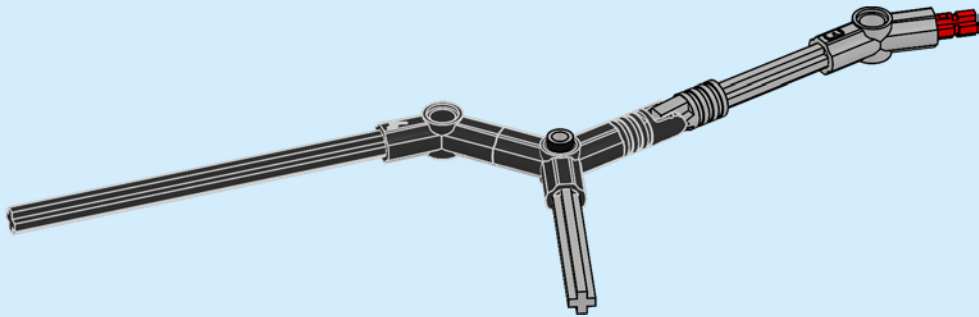



2x

145

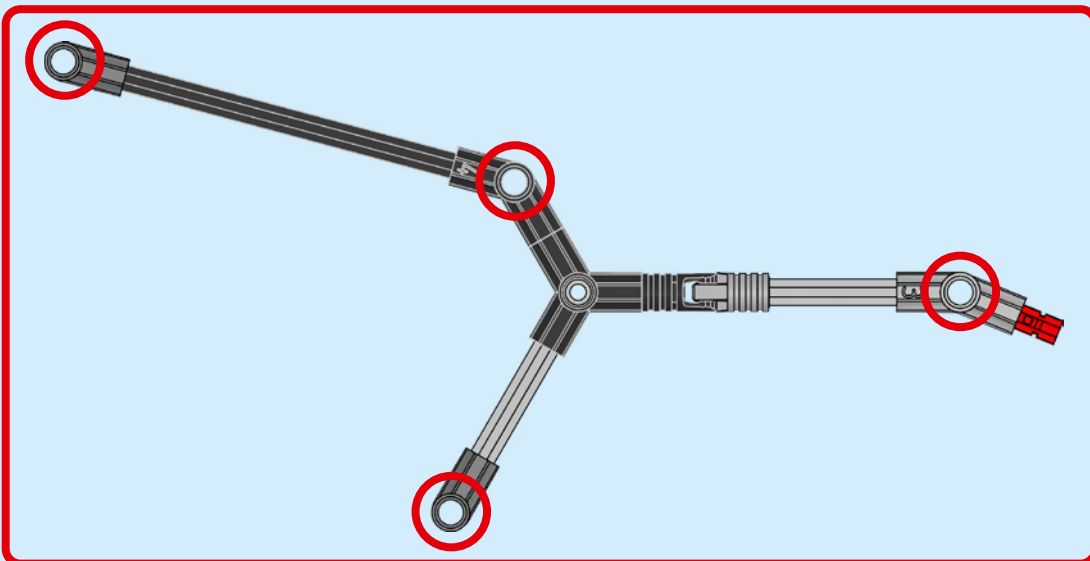
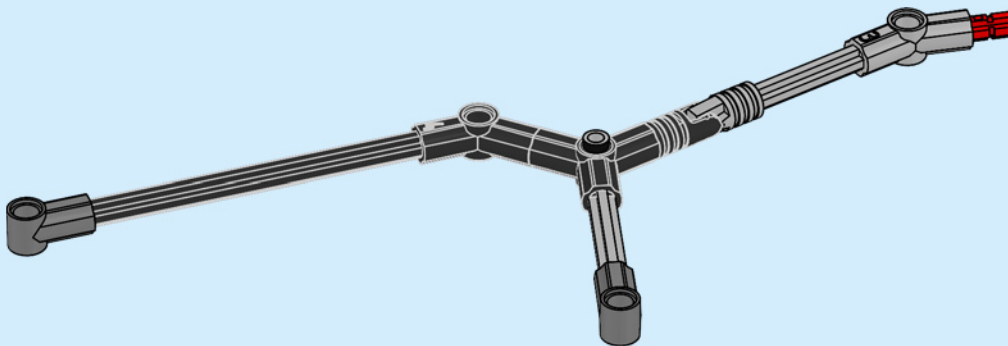





4x

146

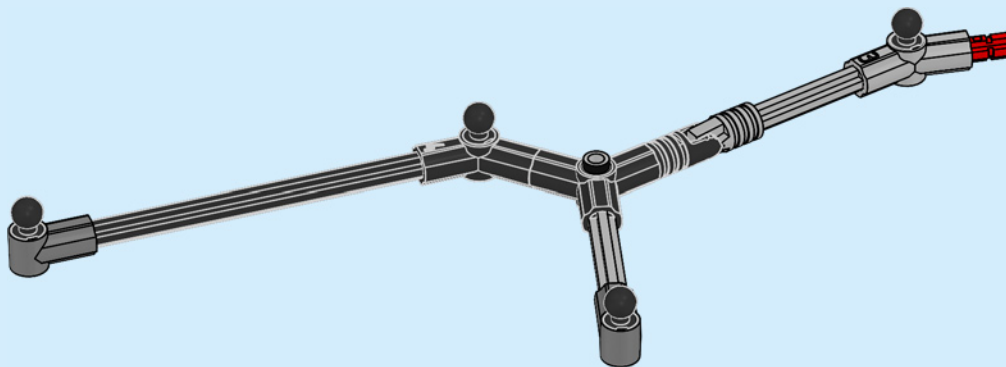

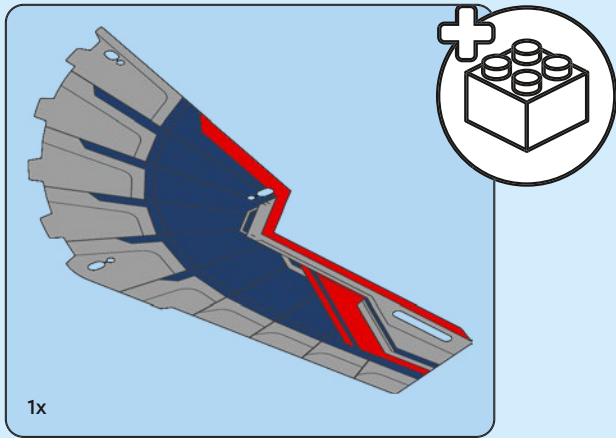

147

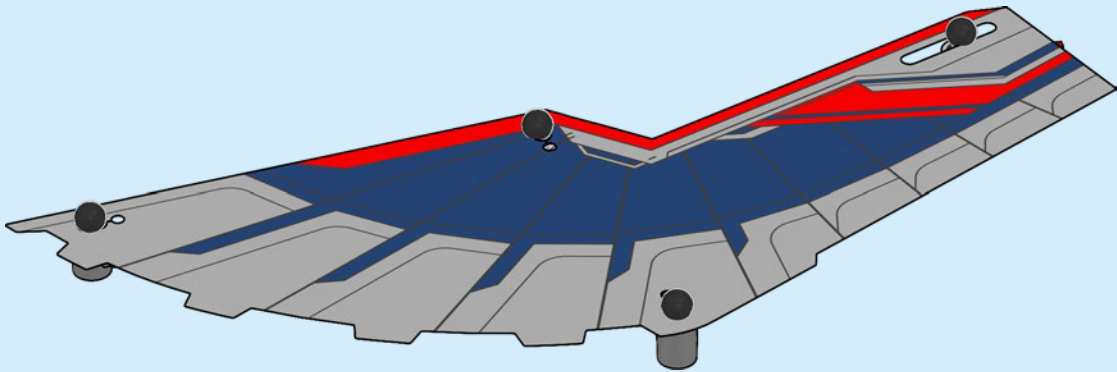

148

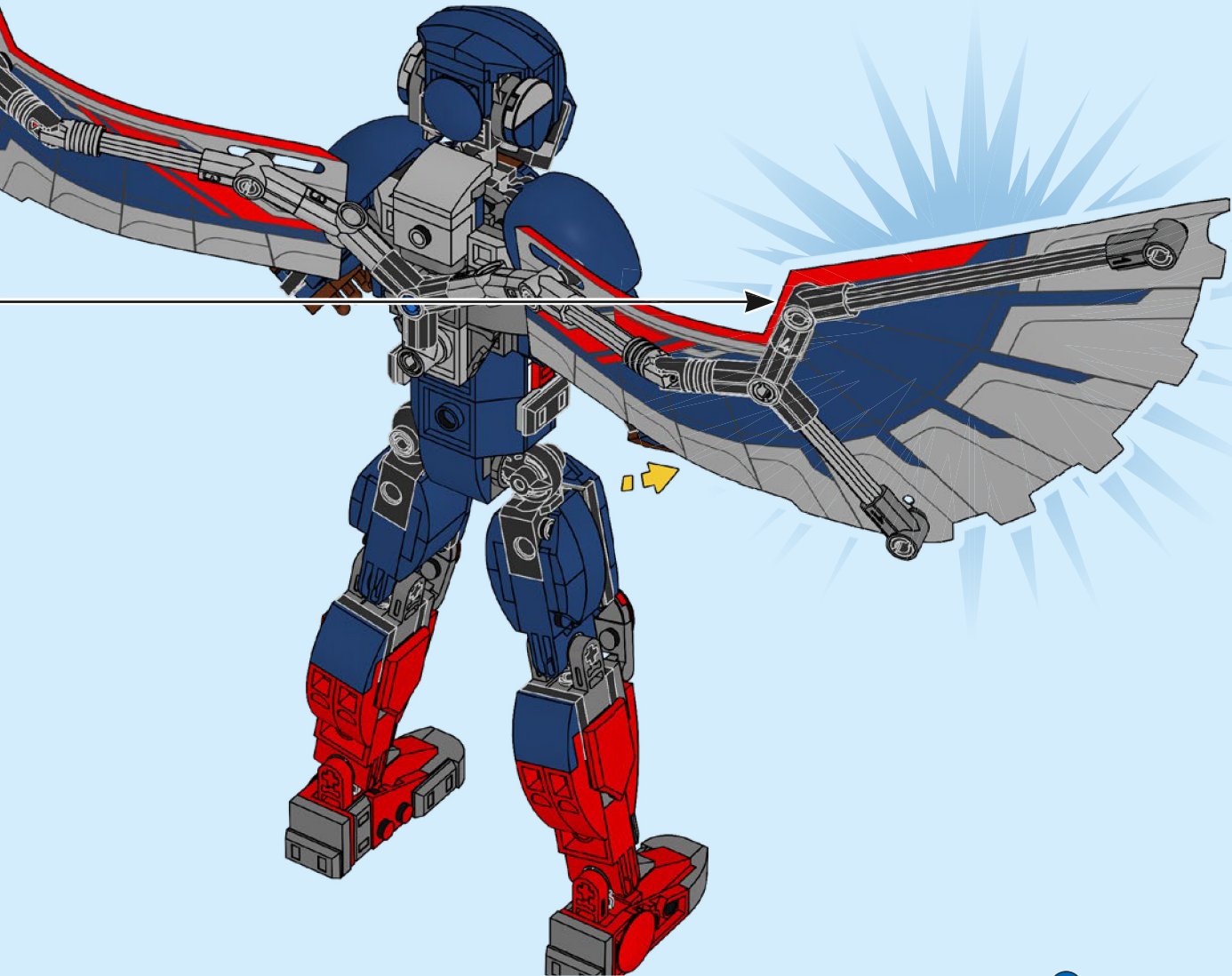



1x



1x

149

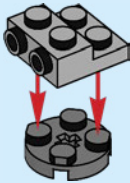

2x

150

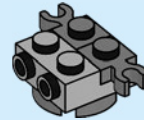

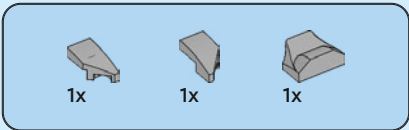

151

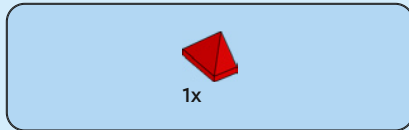
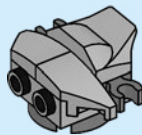

152

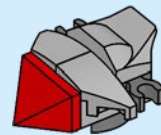

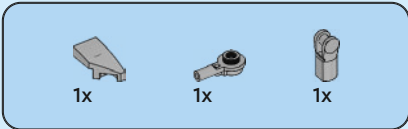

# 153

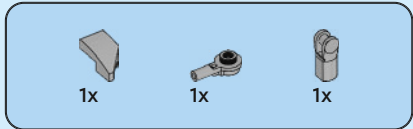
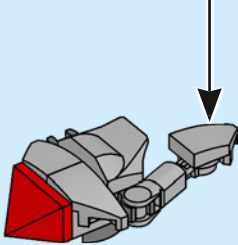
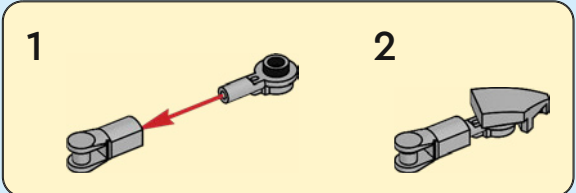

# 154

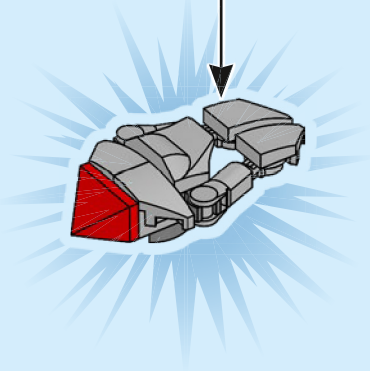
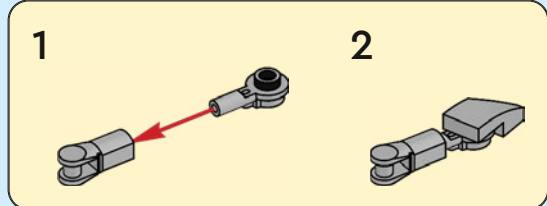

155

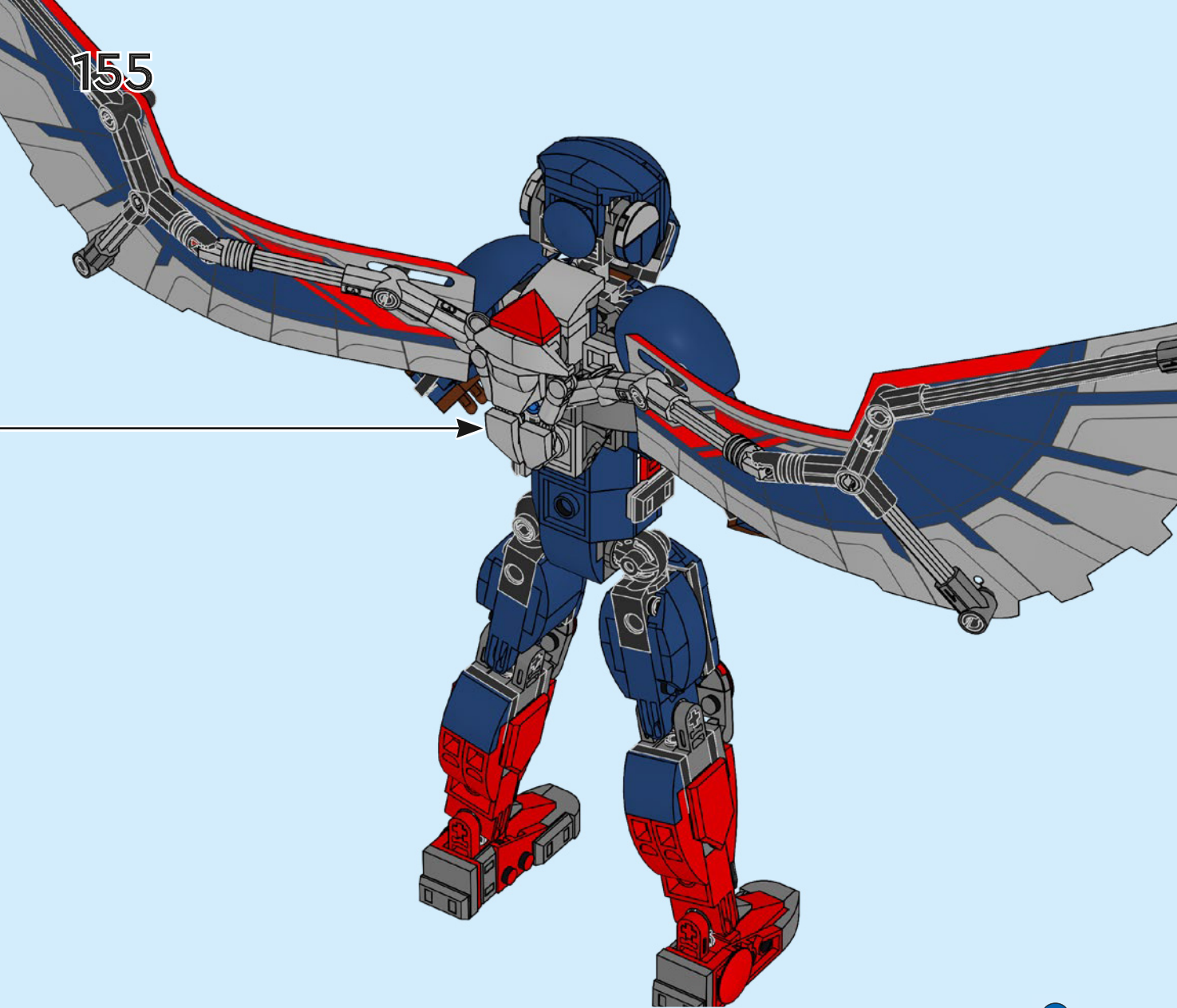

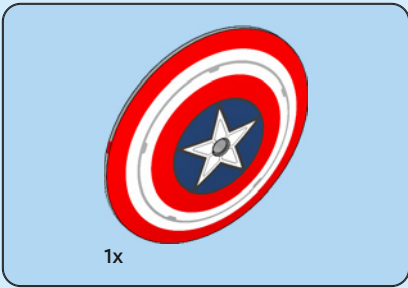

156









4x  
407001



2x  
4547489



1x  
6210076



2x  
6217875



1x  
6360826



4x  
6232135



2x  
6170390



2x  
4180504



2x  
4180533



1x  
6075074



10x  
4142865



4x  
4278275



2x  
6394880



2x  
6092565

90



4x  
370021



2x  
6019155



2x  
6001806



1x  
6313190



1x  
4220515



2x  
6442314



2x  
428621



4x  
6294045



2x  
6371957



1x  
371021



4x  
6057432



2x  
6406930



2x  
4613174



2x  
302324



1x  
6130007



1x  
6424674



6x  
4286267



2x  
6335317



2x  
6234695



8x  
6344752



2x  
6271535



4x  
6279875



2x  
4109810



4x  
6178922



2x  
6174243



2x  
6156991



6x  
302226



4x  
6448318

3



4x  
6330189



2x  
6302828



3x  
302026



2x  
6184784



2x  
370026



1x  
6117973



3x  
6460708



2x  
4213374



1x  
6325254



2x  
6262897



2x  
373726

10



4x  
6416530



13x  
6214811



6x  
6199890



2x  
4255413



1x  
6224384



1x  
6224385



14x  
6214812



1x  
6216905



3x  
6440476



9x  
4528981



4x  
6037886



1x  
6224472



4x  
4528482



2x  
6097420

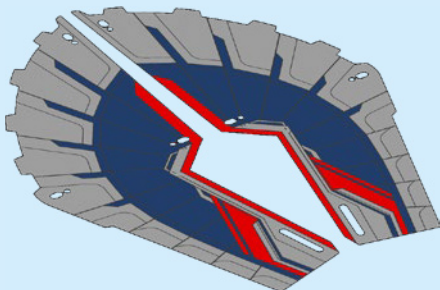

1x  
6478190



1x  
6444582

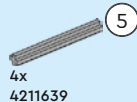

4x  
4211639



4

 [LEGO.com/service](https://www.LEGO.com/service)



YOU COULD **WIN**



Scan this QR code or go to **LEGO.COM/PRODUCTFEEDBACK** and give us your short feedback about this LEGO® set for a chance to win a cool LEGO prize.

Terms and Conditions apply\*



**EN: YOU COULD WIN.** Terms and Conditions apply\* **DE: Du könntest GEWINNEN.** Es gelten die Teilnahmebedingungen\* **FR: Tu pourrais GAGNER.** Des conditions s'appliquent\* **IT: Potresti VINCERE tu.** Termini e condizioni sono applicabili\* **ES: Puedes GANAR.** Aplican términos y condiciones\* **PT: Poderá GANHAR.** Aplicam-se termos e condições\* **ZH: 轻松获奖. 条款和条件适用\*** **PL: Szansa na WYGRANĄ.** Obowiązują warunki korzystania\* **CS: Máte šanci VYHRÁT.** Platí všeobecné smluvní podmínky\* **SK: Máte šancu VYHRAŤ.** Platia všeobecné zmluvné podmienky\* **HU: TE IS NYERHETSZ.** Felhasználási feltételek érvényesek\* **RO: Ai putea CÂȘTIGA.** Se aplică termeni și condiții\* **BG: Можете да СПЕЧЕЛИТЕ.** Има определени правила и условия\* **LV: Tu vari LAIMĒT.** Ir spēkā noteikumi un nosacījumi.\* **ET: Sul on võimalus VÕITA.** Kehtivad tingimused\* **LT: Jūs galite LAIMĖTI.** Taikomos sąlygos\*

\*[LEGO.com/productfeedback-terms](https://www.lego.com/productfeedback-terms)

LEGO and the LEGO logo are trademarks of the/son des marques de commerce du/son marcas registradas de LEGO Group.

©2024 The LEGO Group.

© 2024 MARVEL

6512872