



# STAR WARS



9500



1

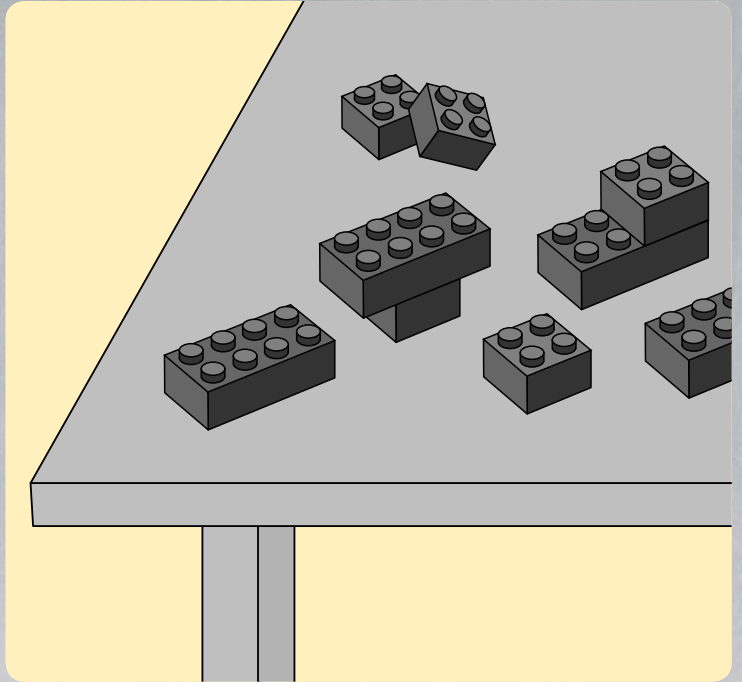
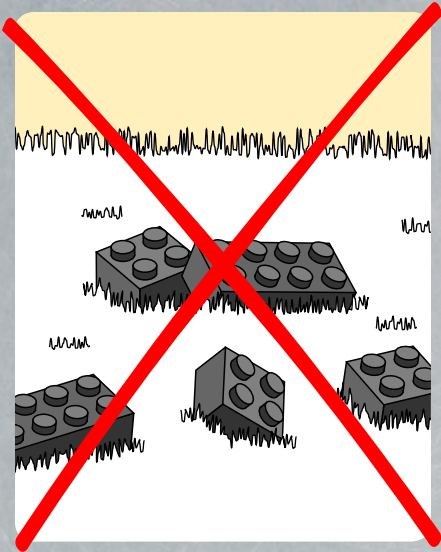

2



<http://lego.com/brickseparator>

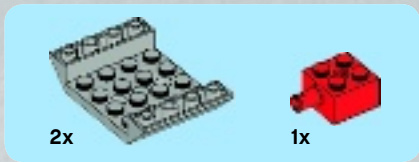
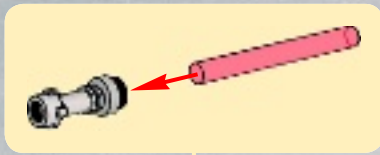

1

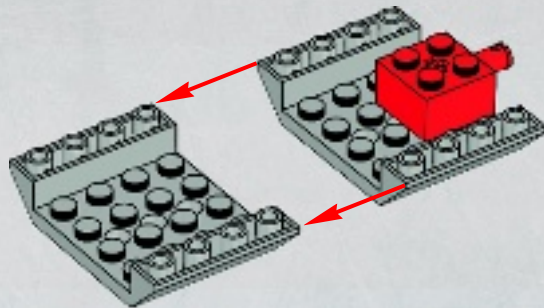



1x

# 2

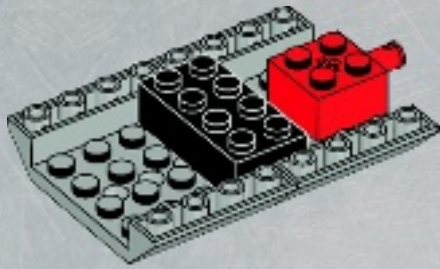

1x



3x



2x

# 4

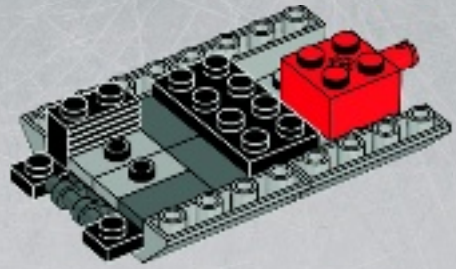

2x



1x



1x

# 3

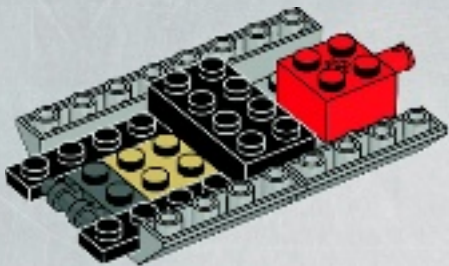

2x



2x



2x



2x

# 5

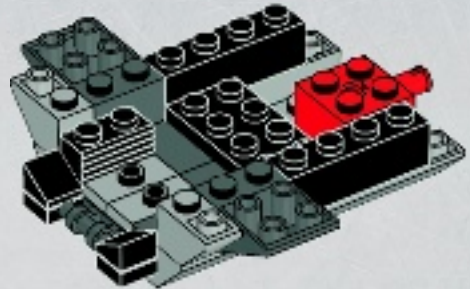

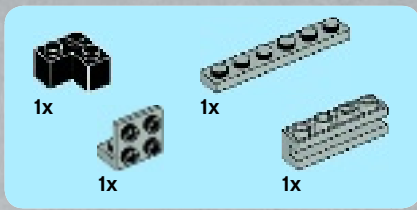

6

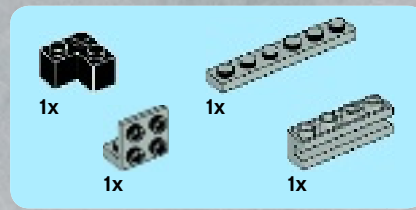
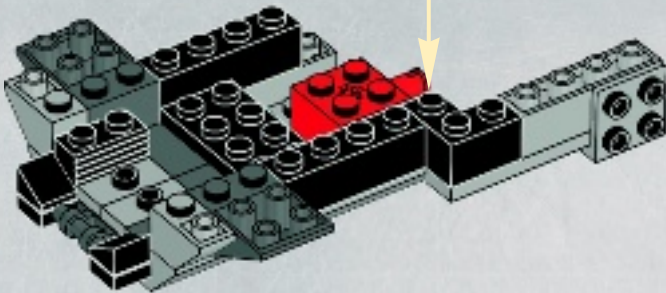
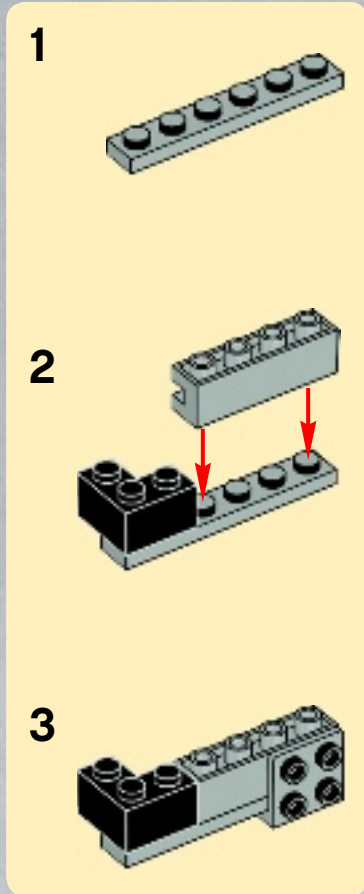

7

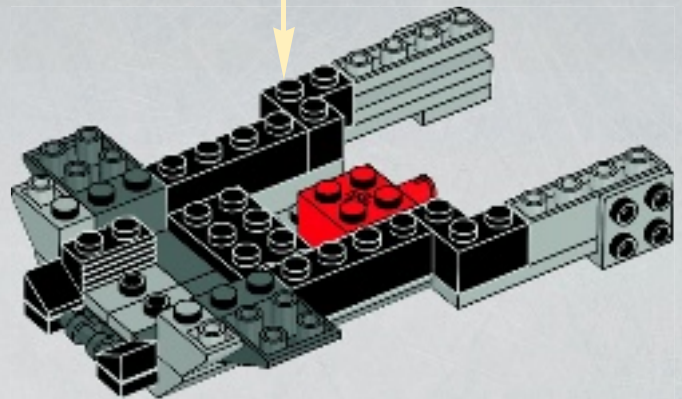
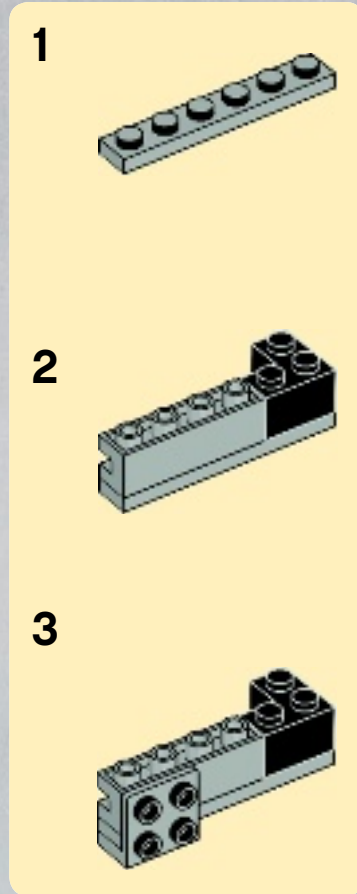

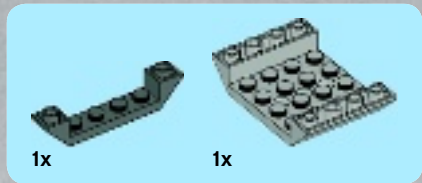

1

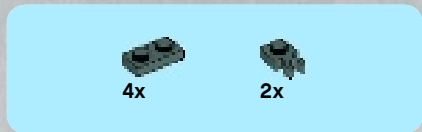
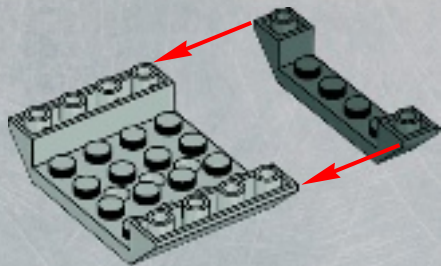

2

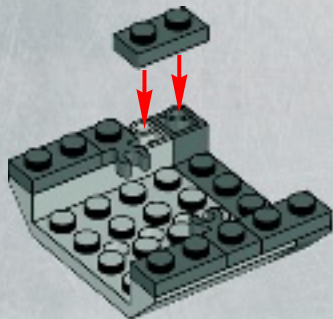

3

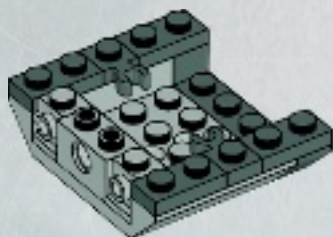

4

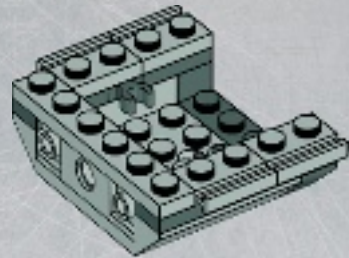

5

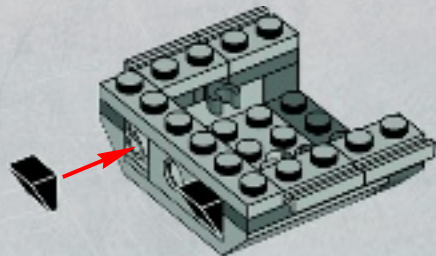

6

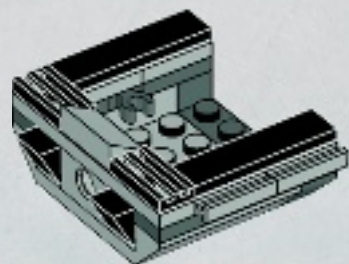

8

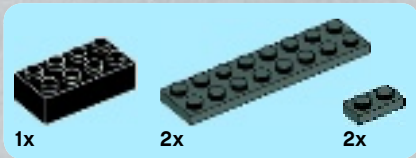
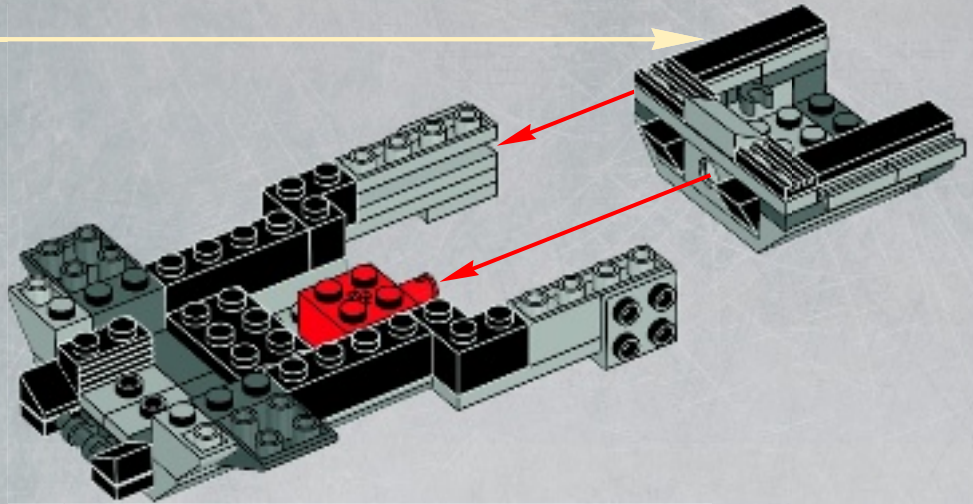

9

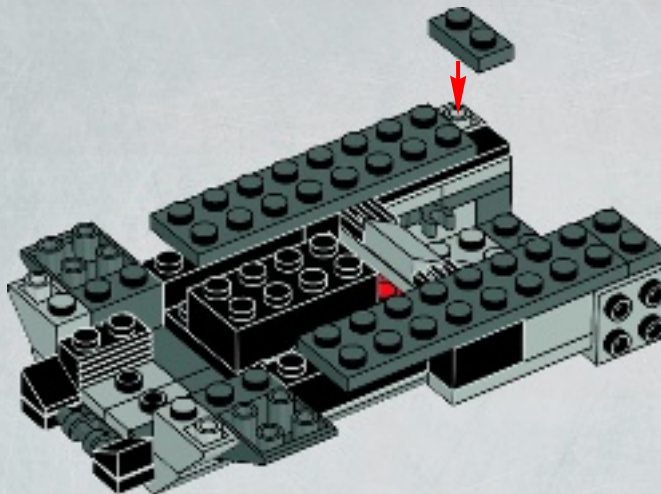



# 10

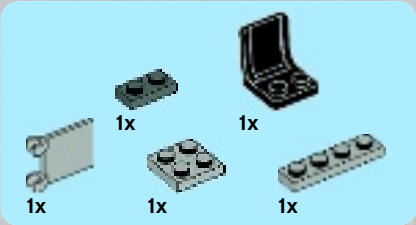
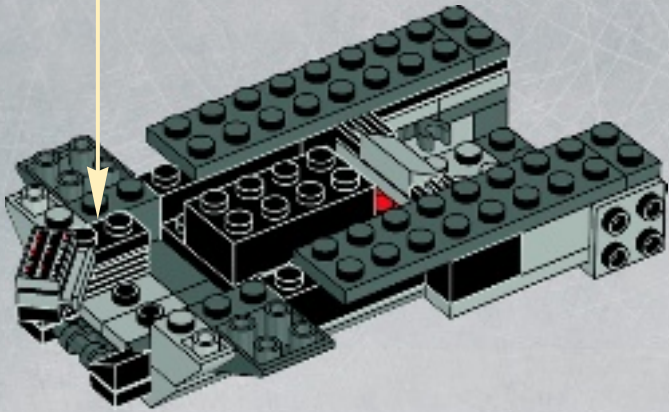

# 11

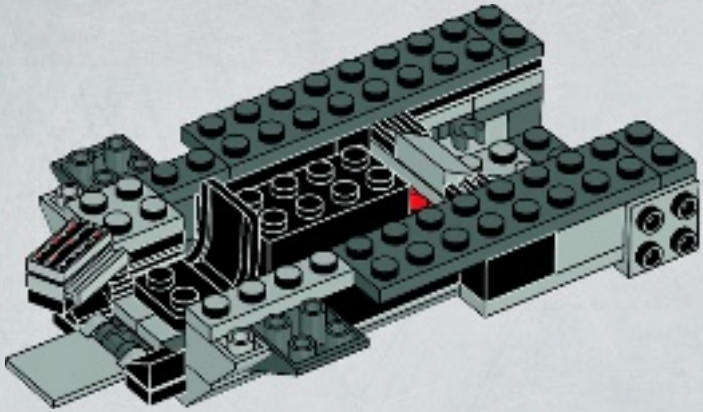



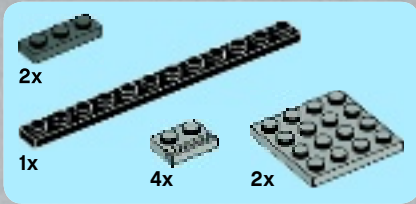

# 12

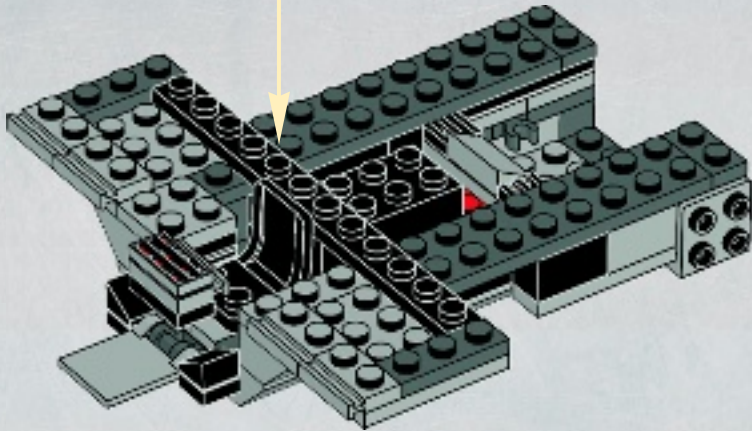
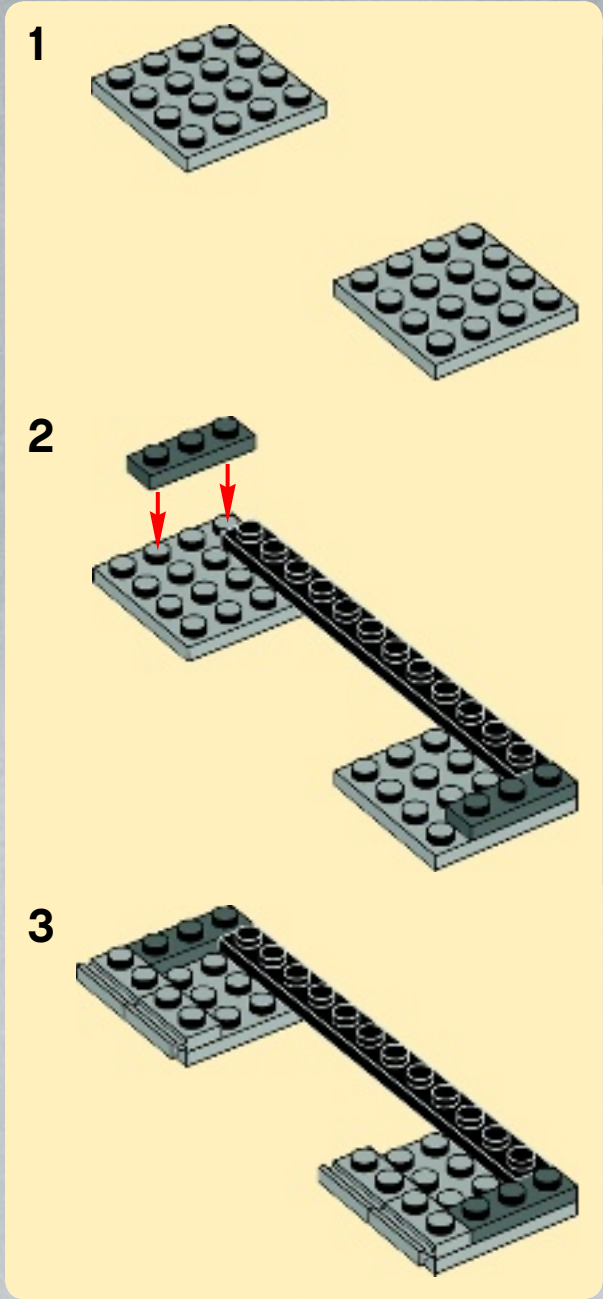

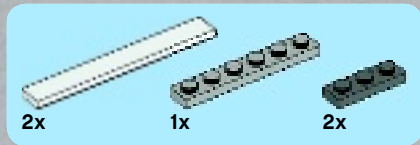

13

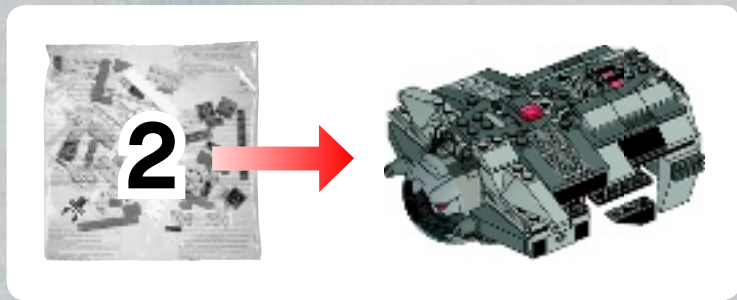
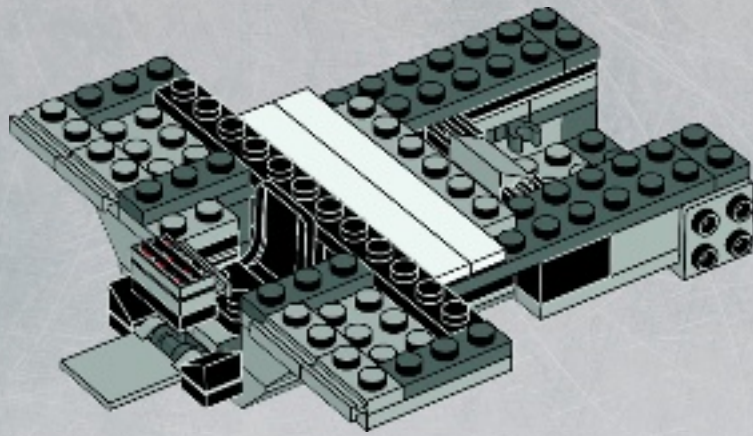

14

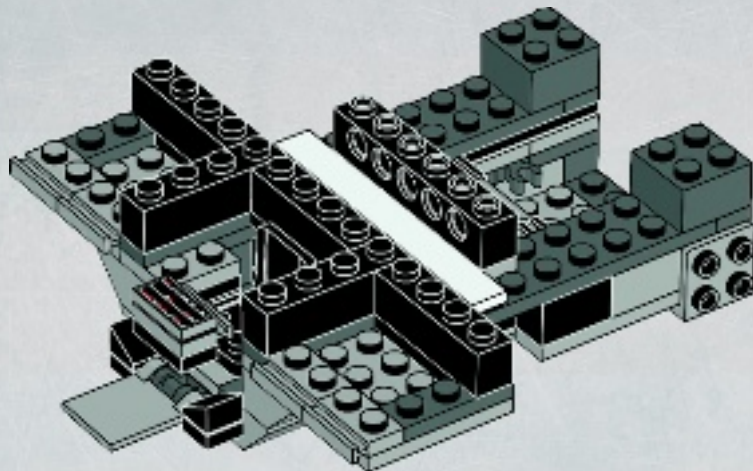



4x



2x

# 15

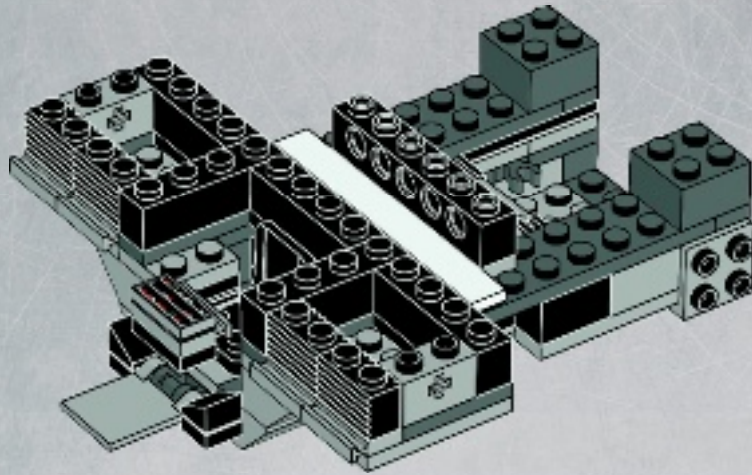

1x



1x



2x



2x



2x

# 16

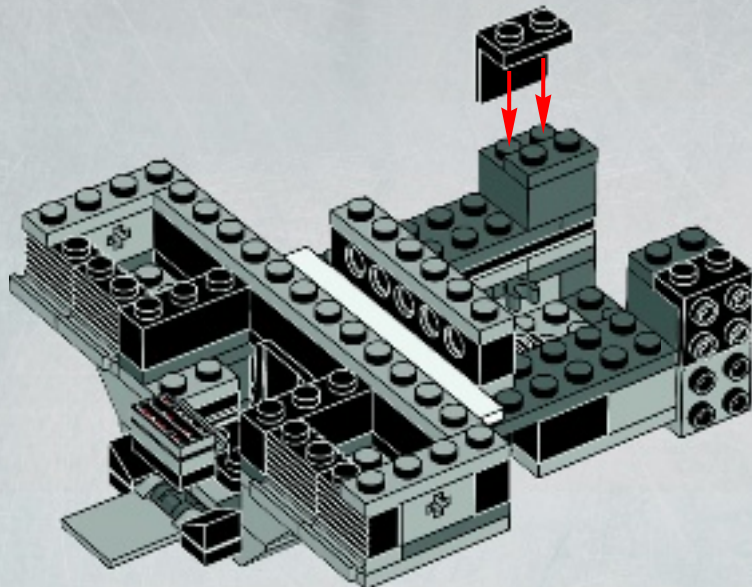



4x



2x

# 17

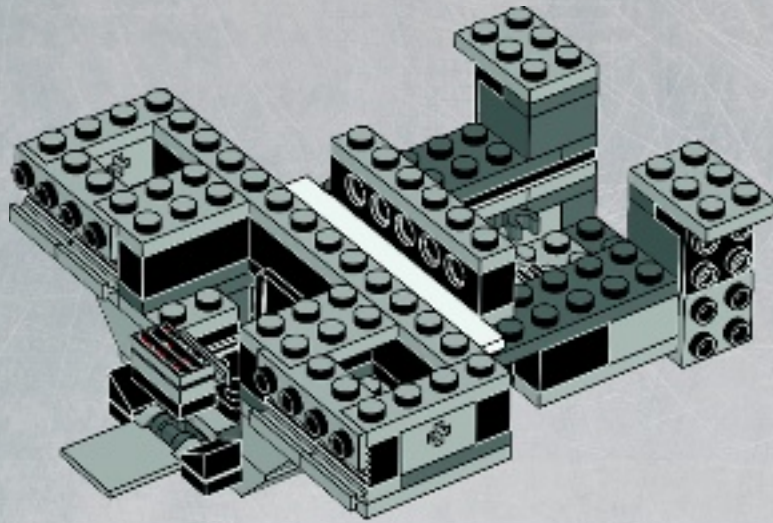

2x



2x

# 18

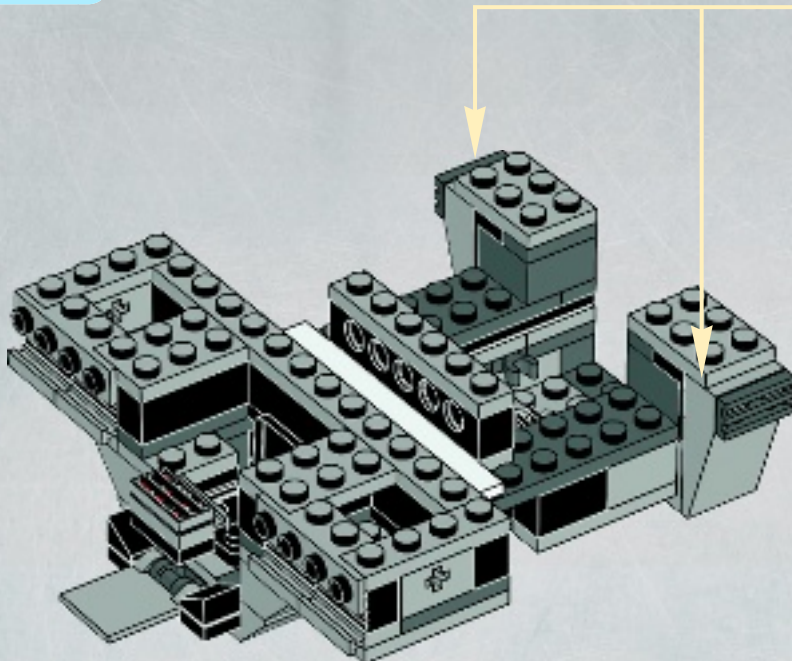

2x

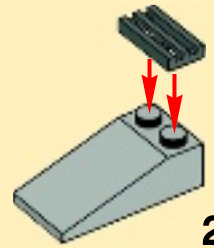

2x

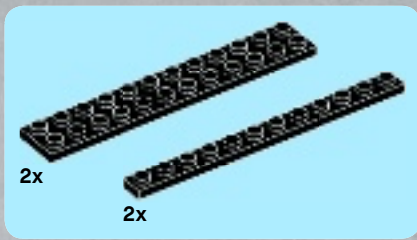

# 19

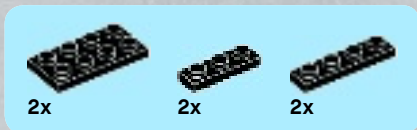
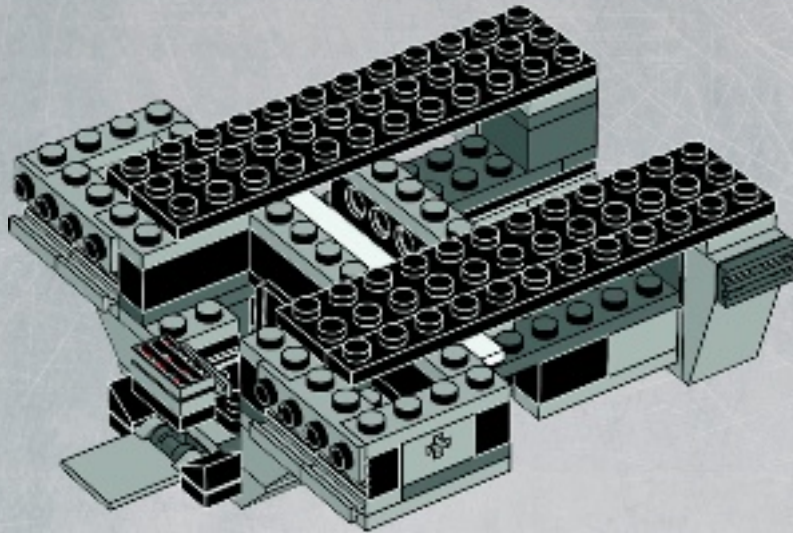

# 20

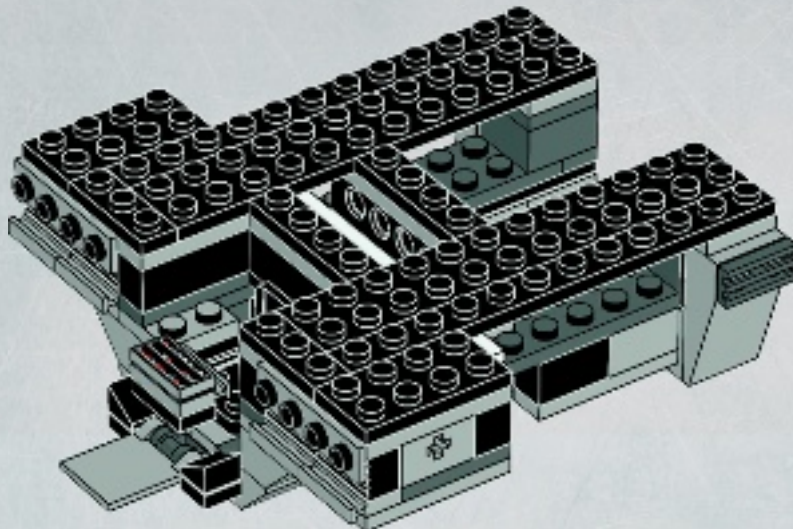



2x



2x

# 21

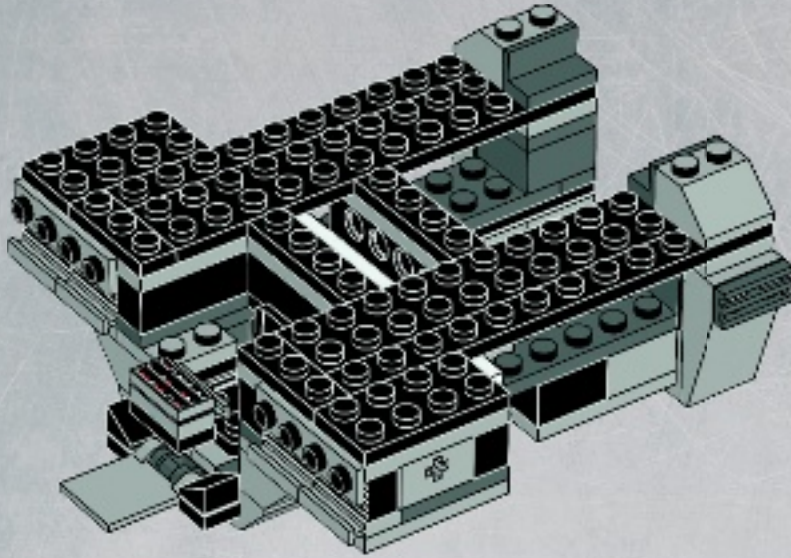

2x



2x

# 22

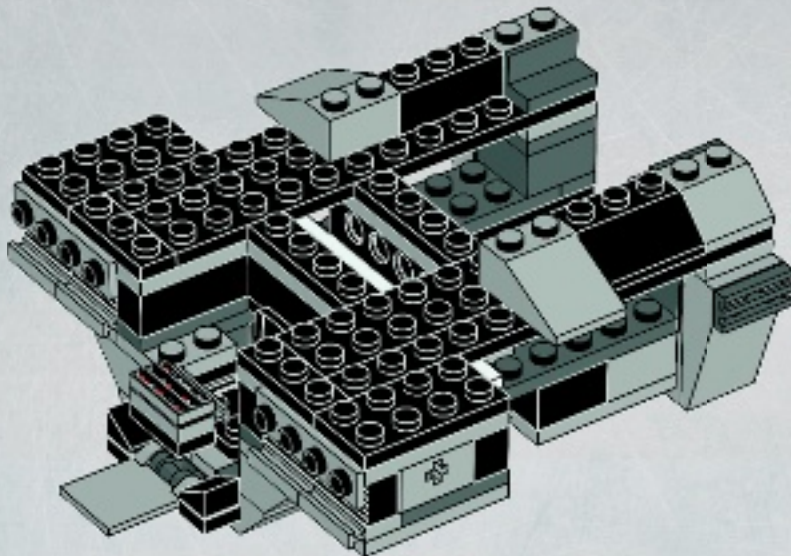

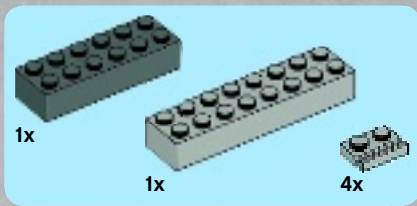

# 23

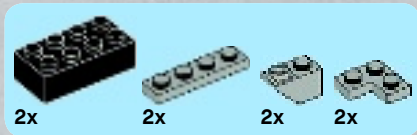
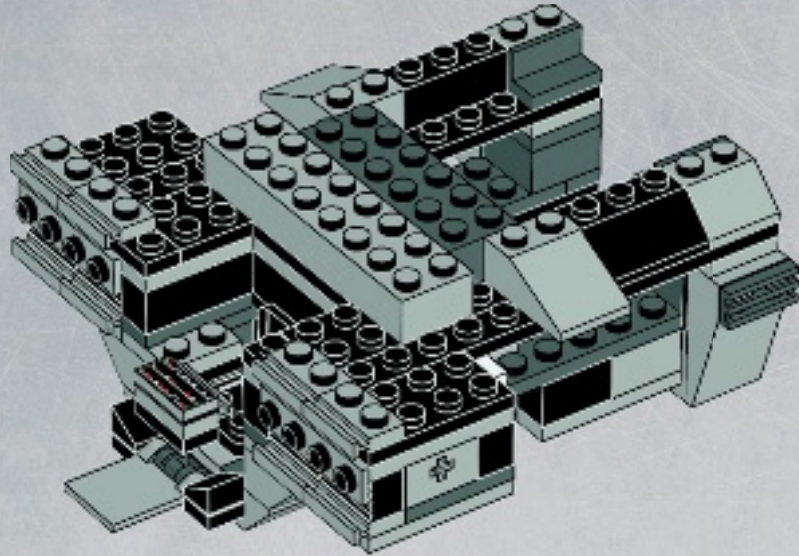

# 24

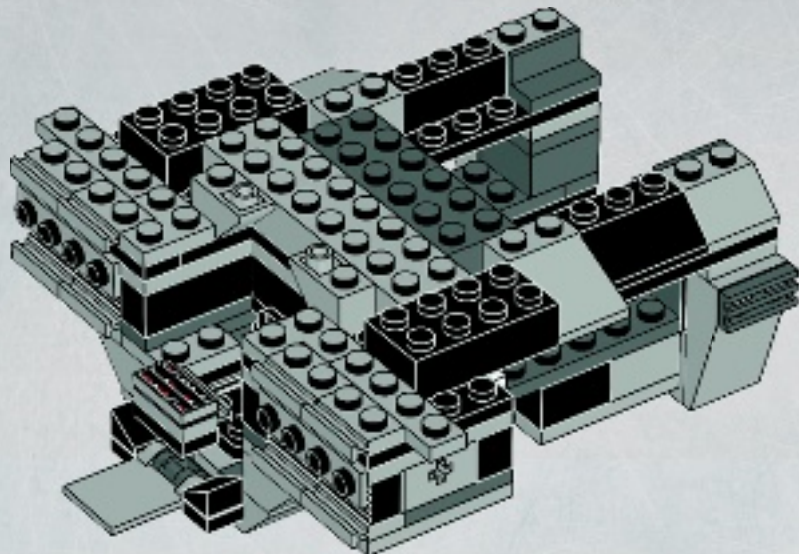



2x

2x

6x

4x

# 25

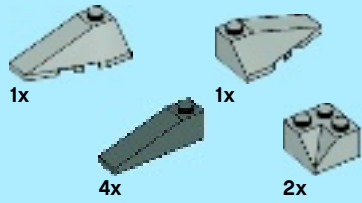
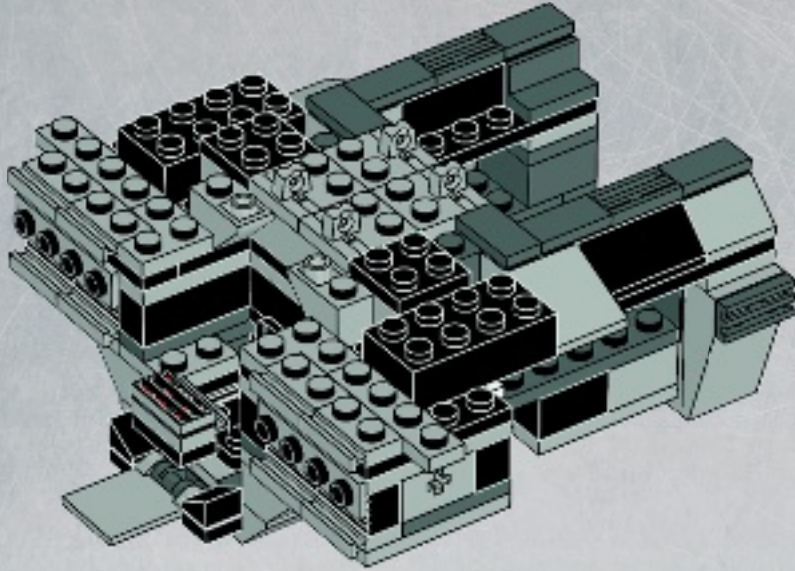

1x

1x

4x

2x

# 26

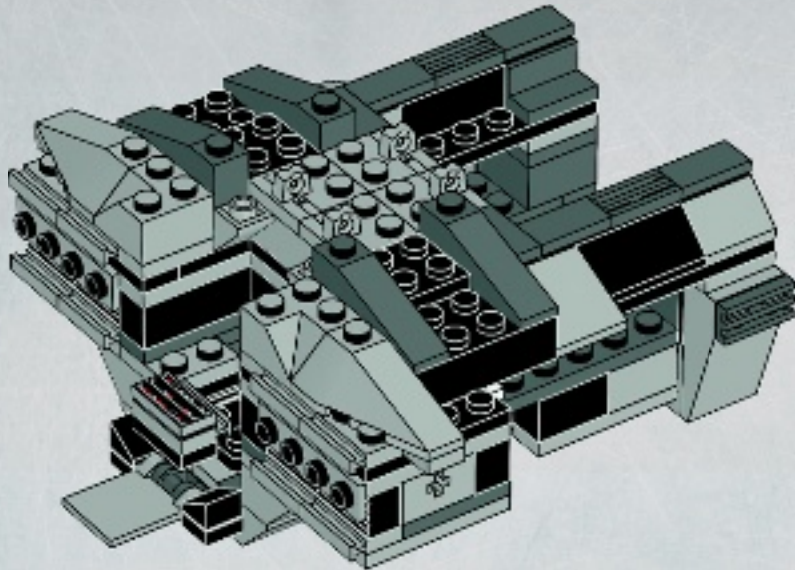





1x



8x



1x



2x

# 27

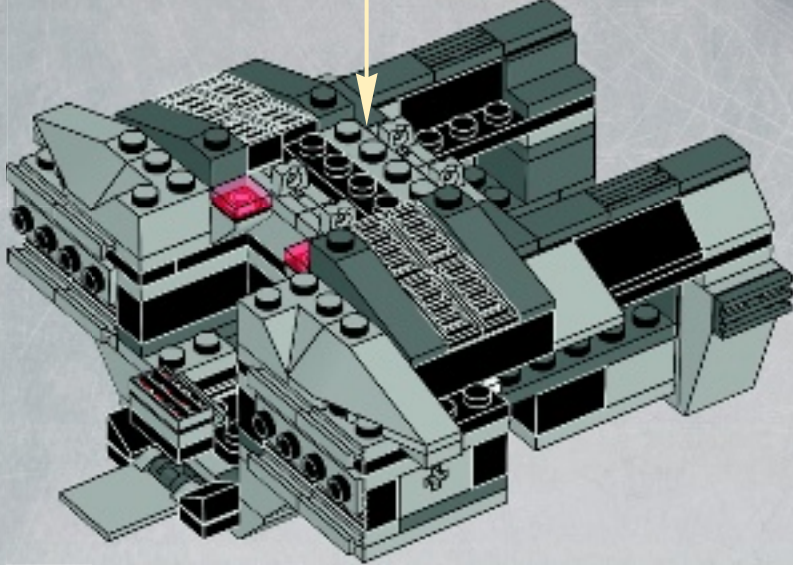

1x



2x

# 28

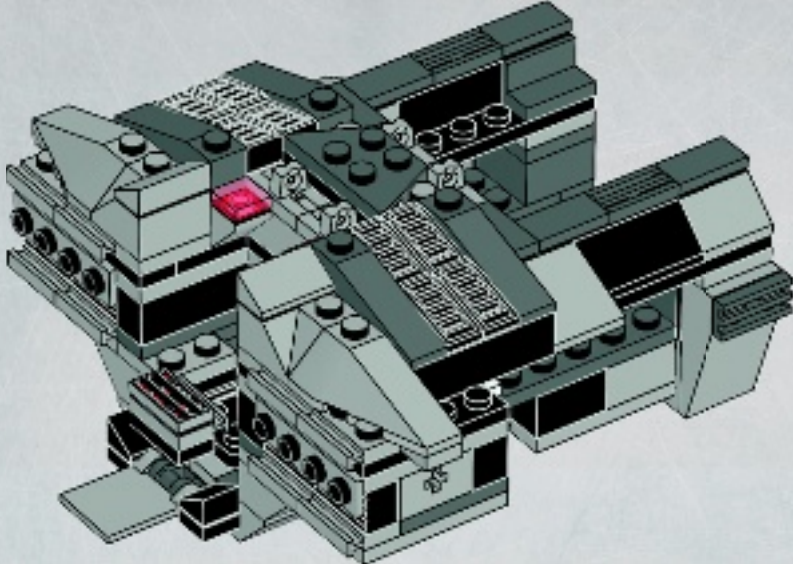



1x



2x



1x

# 29

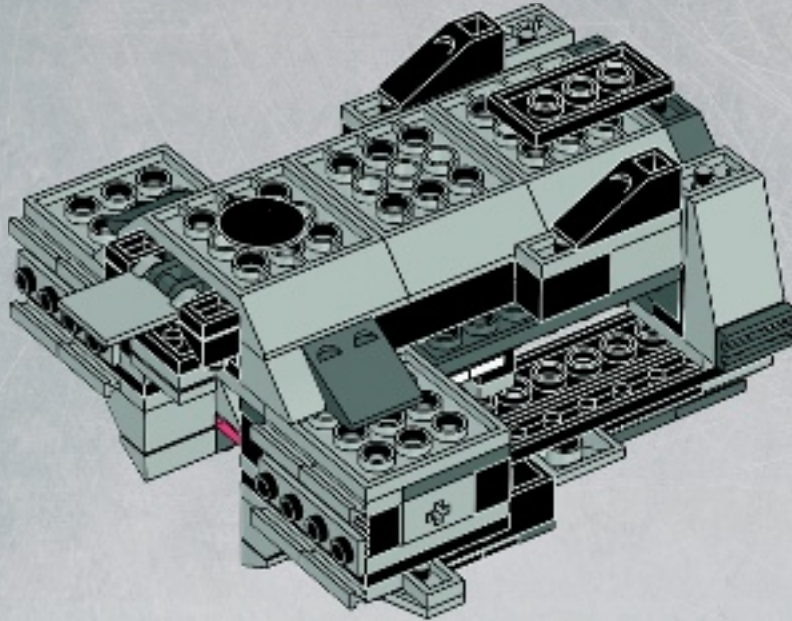

1x



1x



2x

# 30

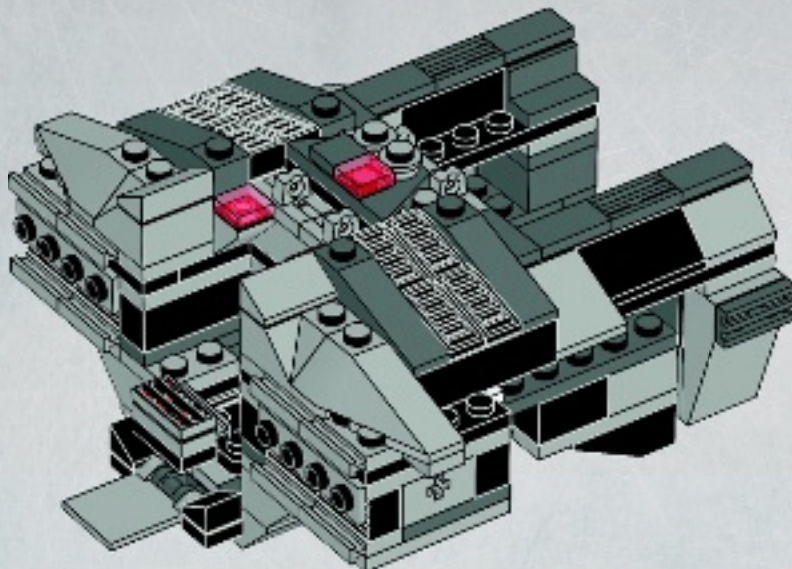

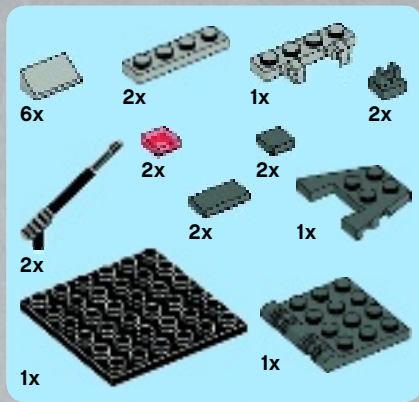

**31**

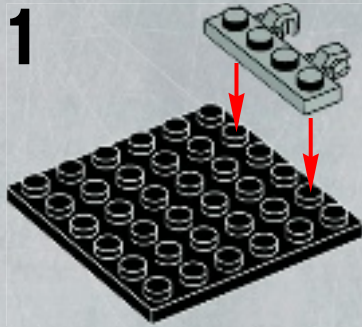

**1**

**2**

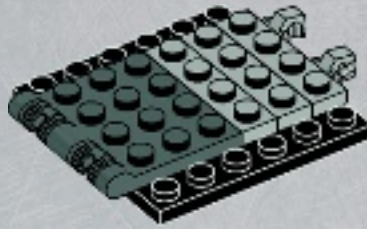

**3**

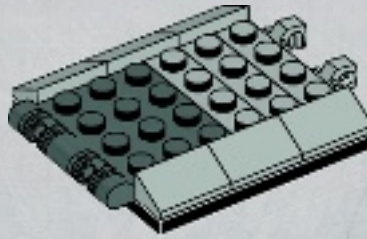

**4**

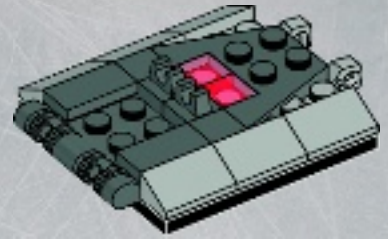

**5**

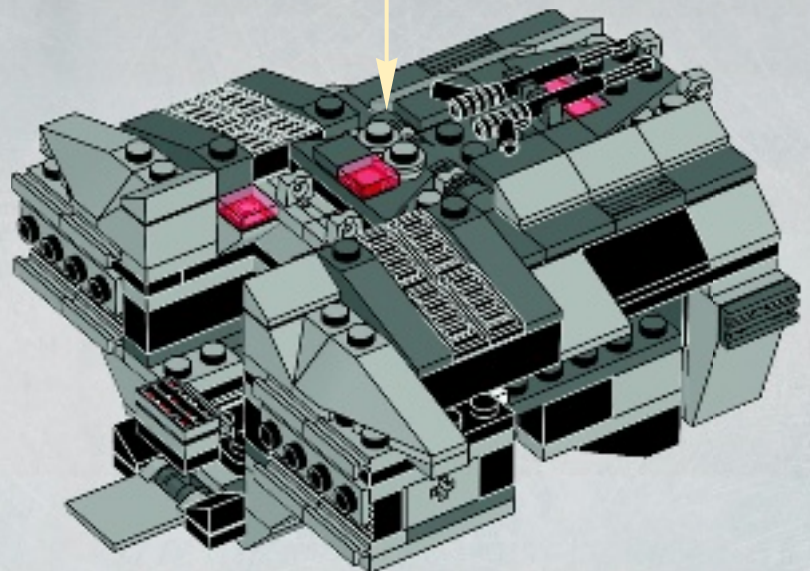
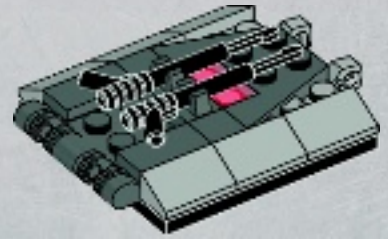



1

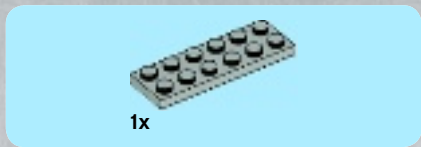
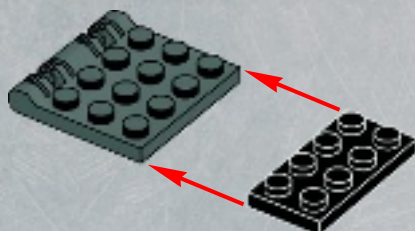

2

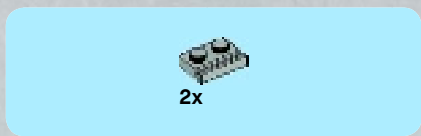

3

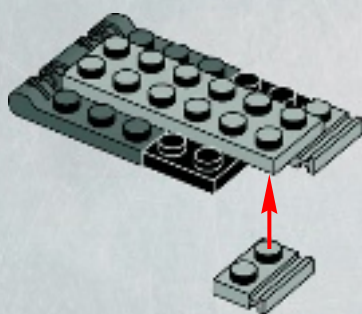

4

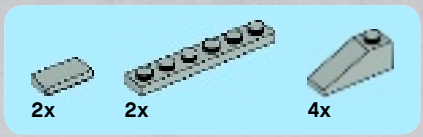
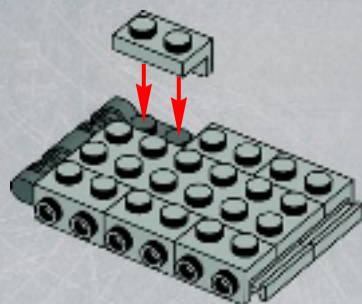

5

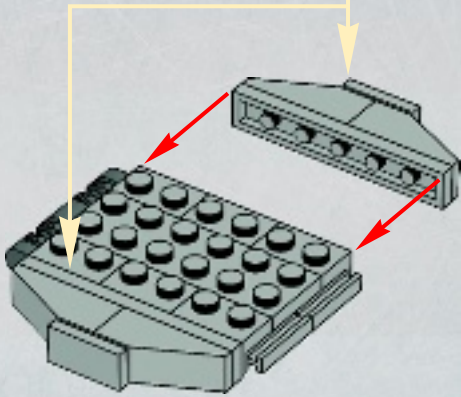
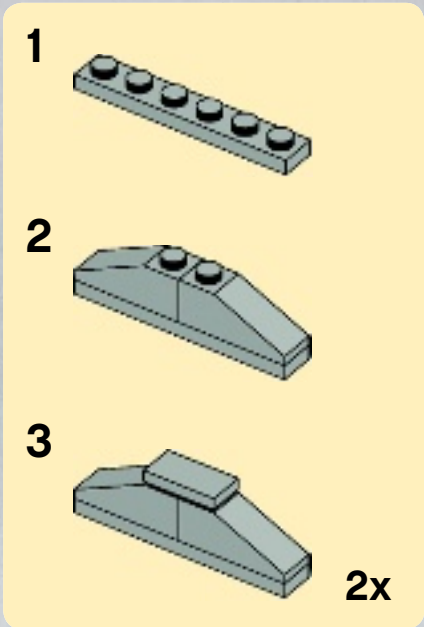



2x



2x



2x

6



2x

7



32

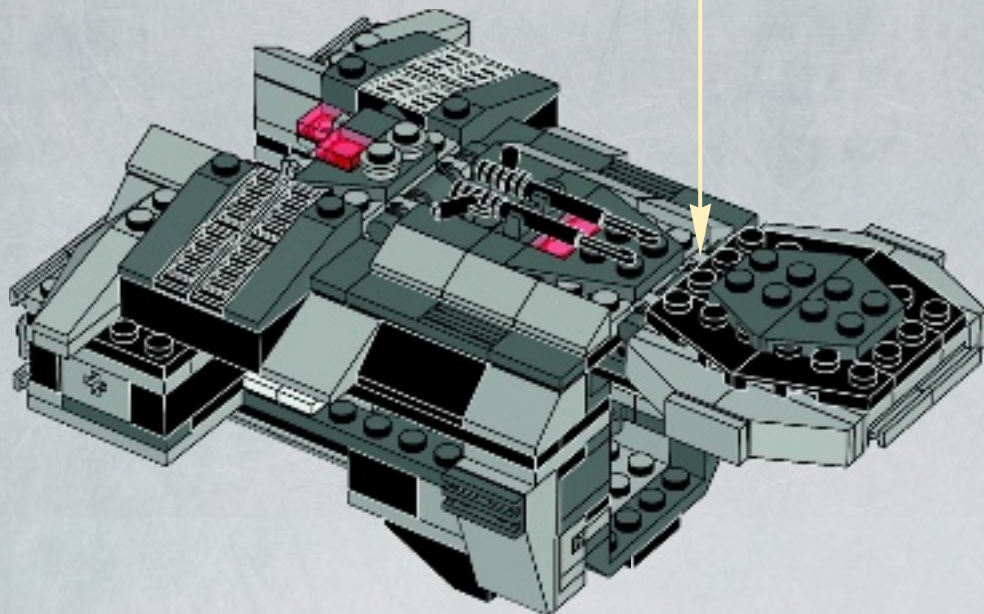



2x



2x

# 33

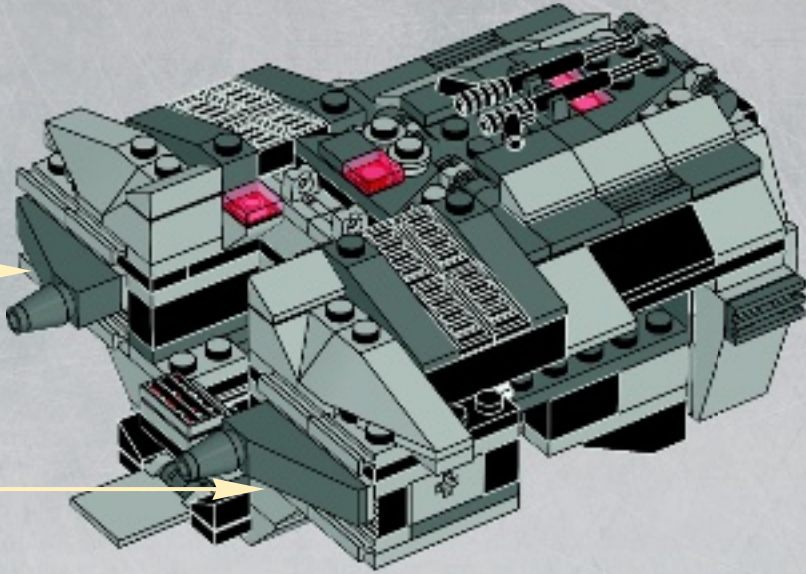
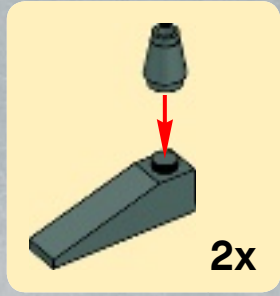

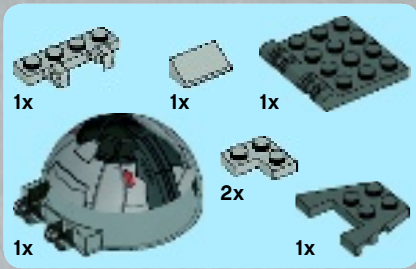

# 34

1



2



3



4



5

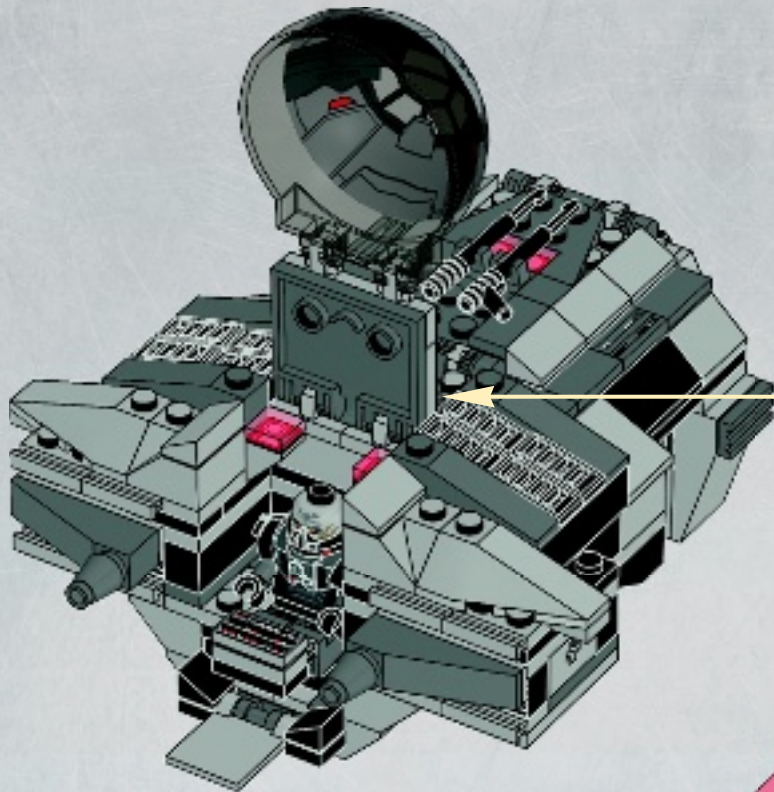
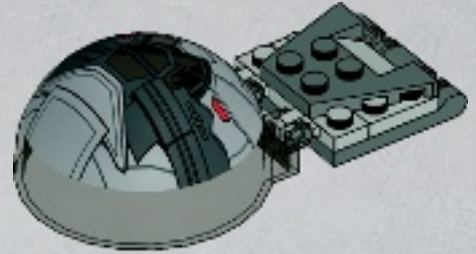

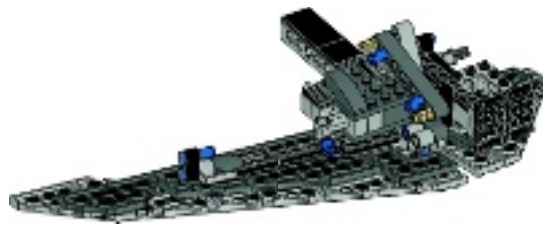

1x

1



1x



2x

2

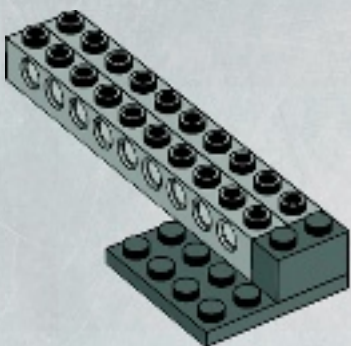

2x

3

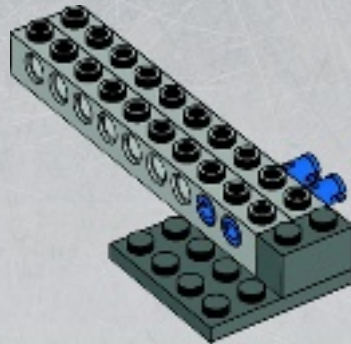

1x



1x

4

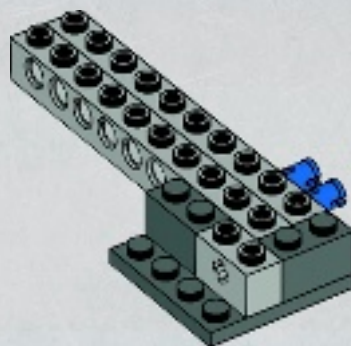





3x

# 5

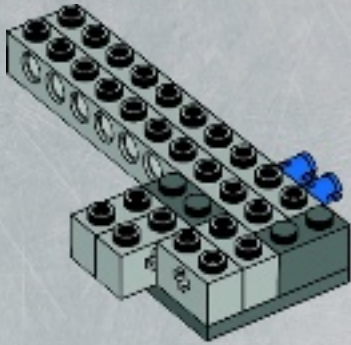

2x



1x



1x

# 7

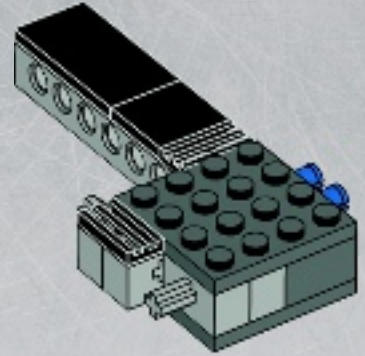

2x



1x

# 6

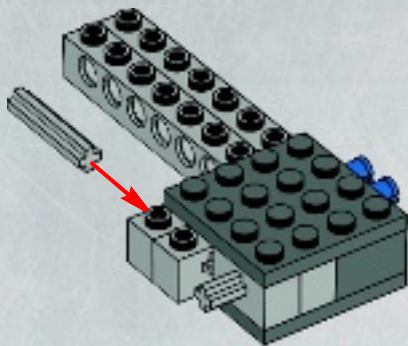

1x



1x



1x



1x

# 8

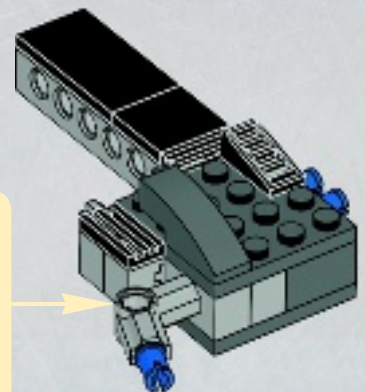
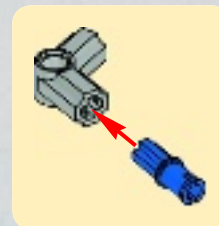

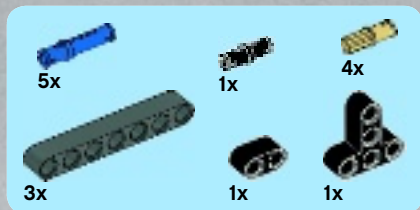

9

1



2



3

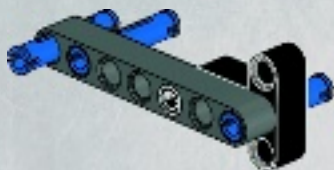

4

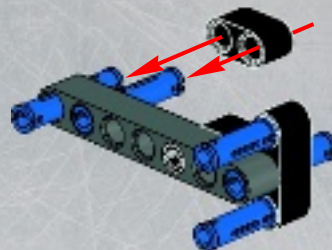

5

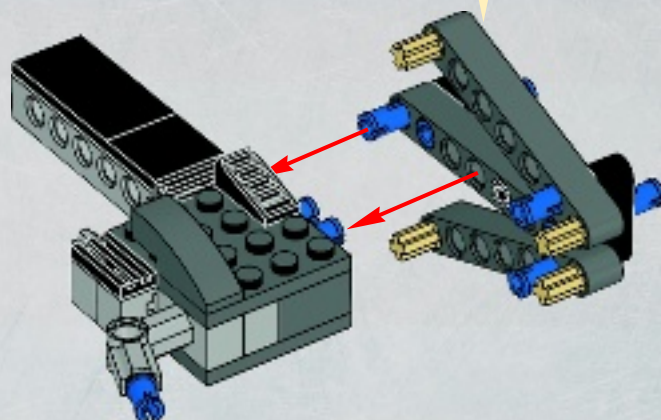
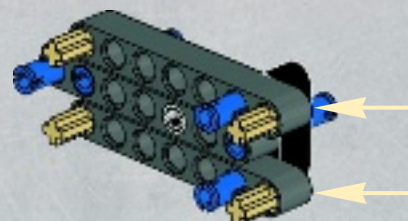
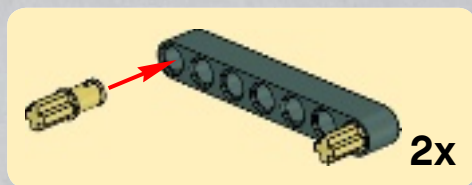



# 10

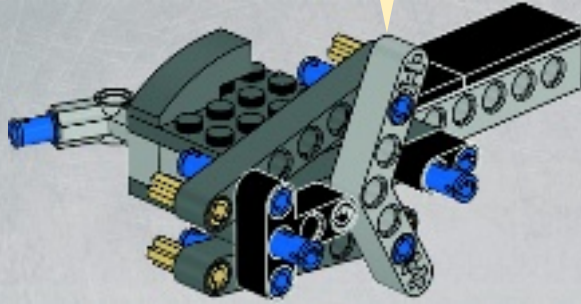
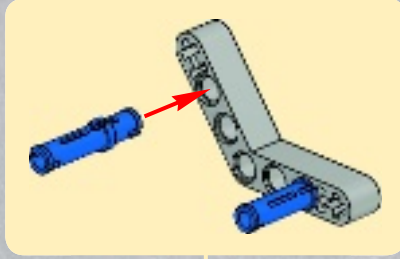

# 11

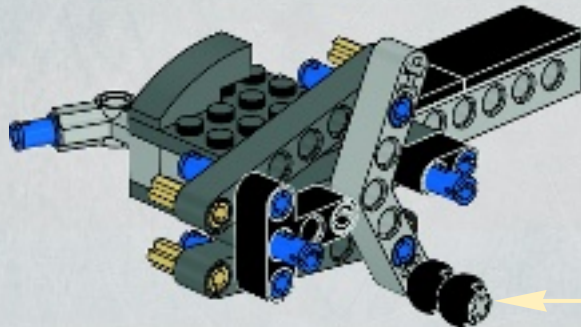
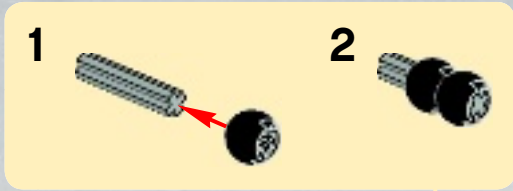



1x



1x

1

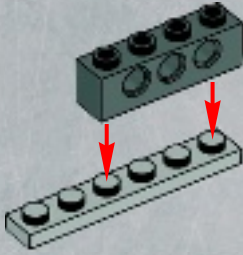

1x

4

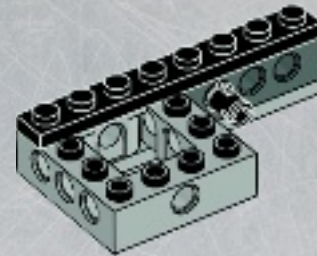

1x

2

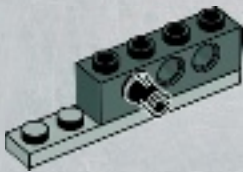

1x

5

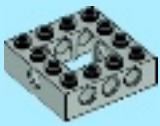
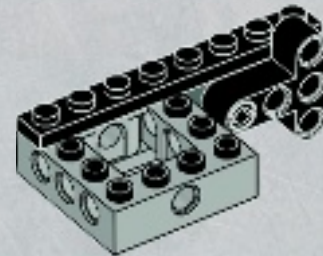

1x

3

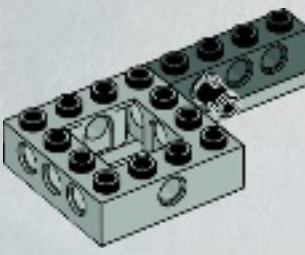

2x

6

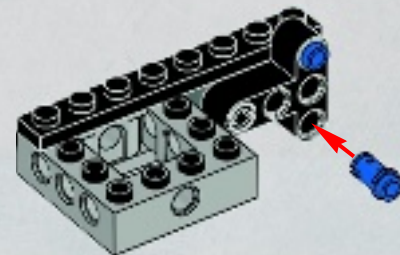

1x

1x

7

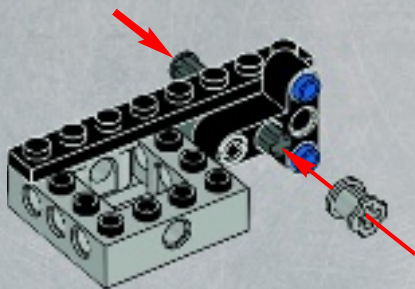

4x

2x

8

1



2



2x

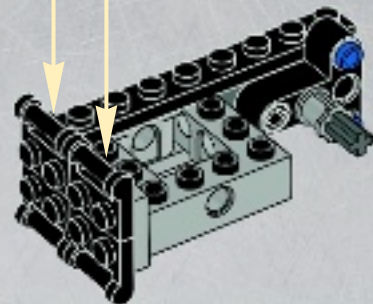

12

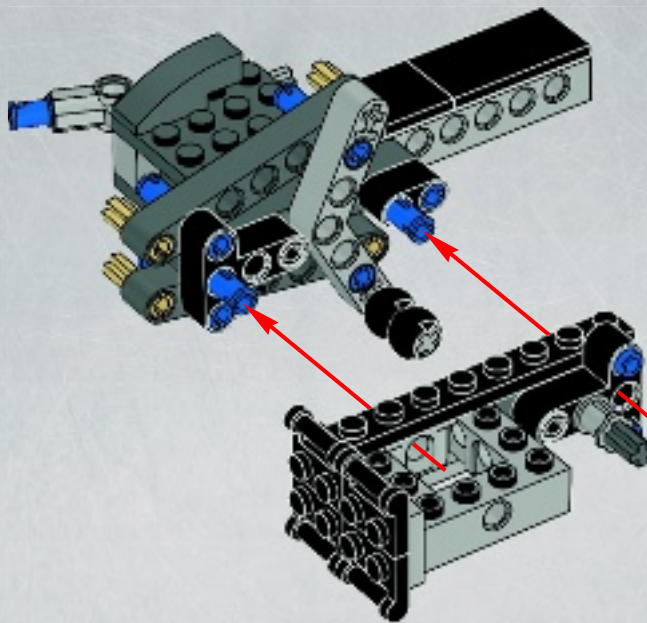

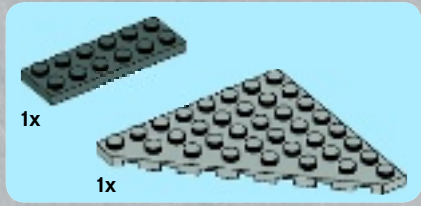

1

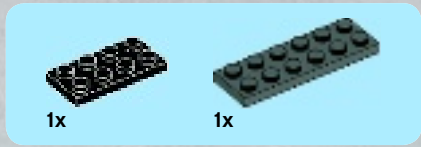
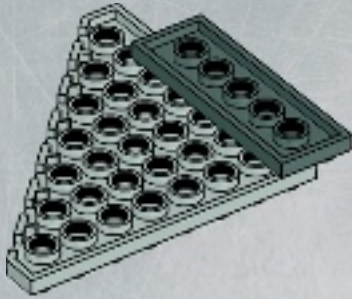

2

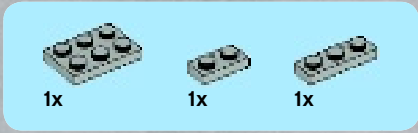
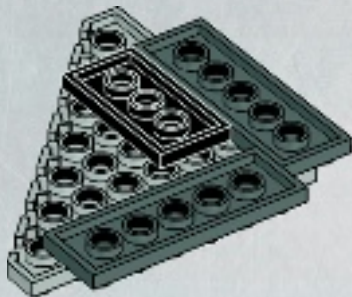

3

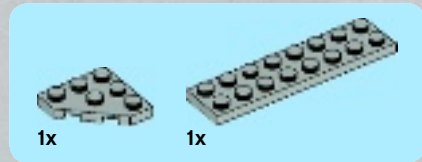
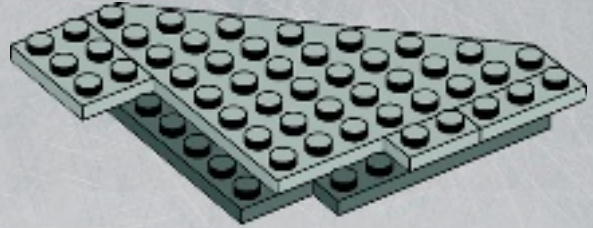

4

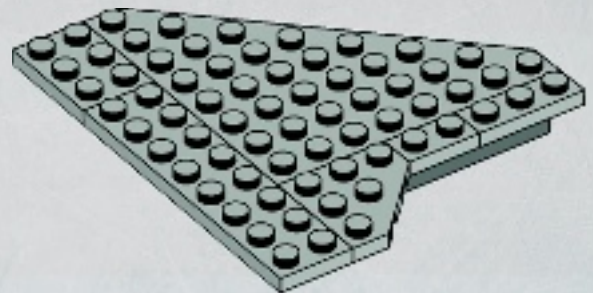



1x



2x

5

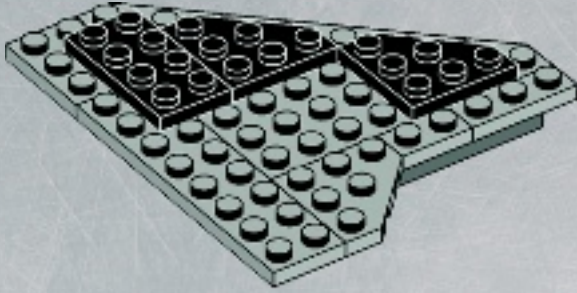

1x



1x

7

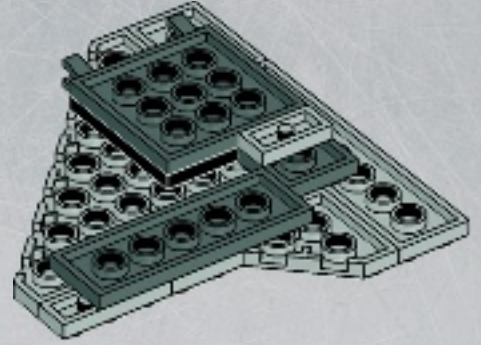

1x



2x



1x

6

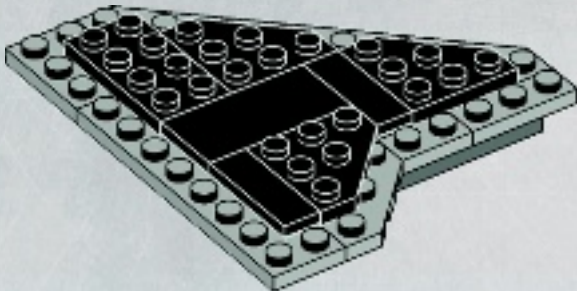

1x



1x



1x

8

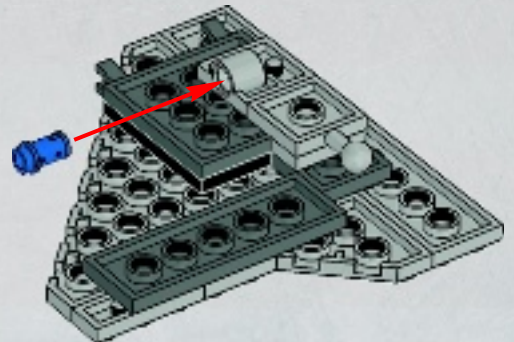

# 13

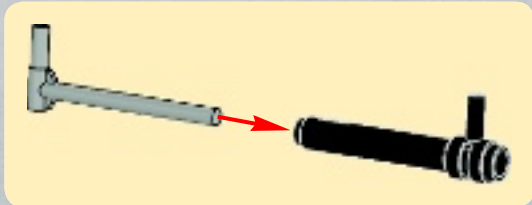
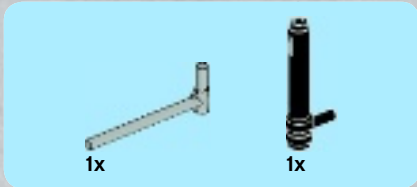
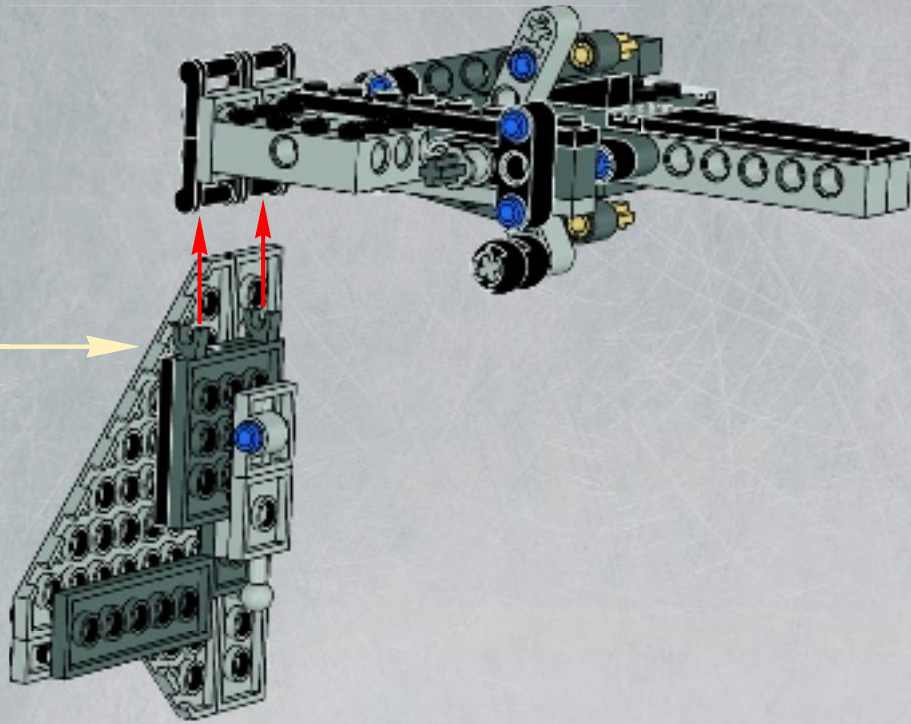

# 14

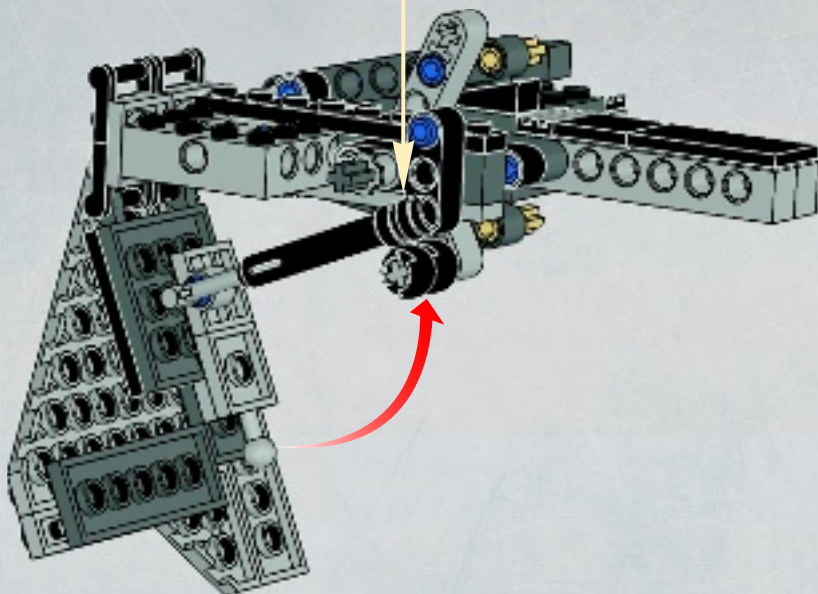



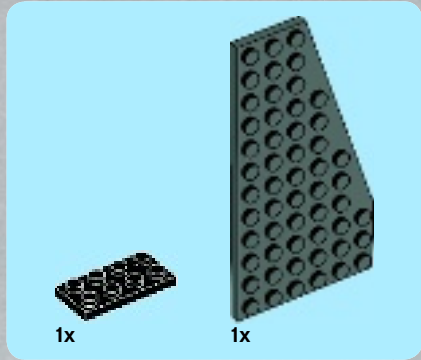

1

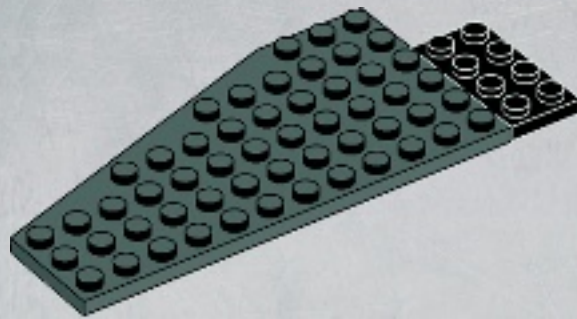

2

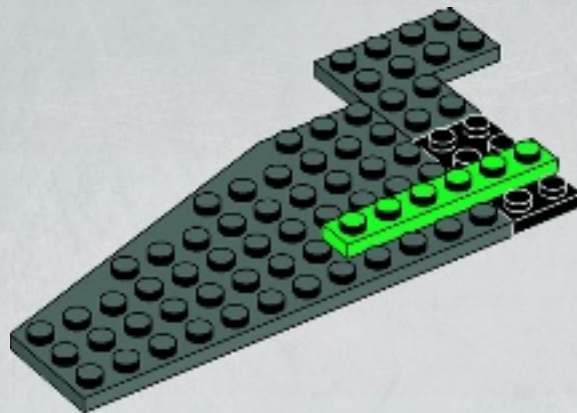

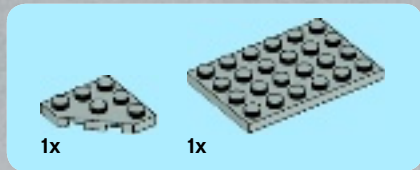

3

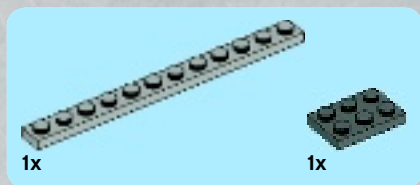
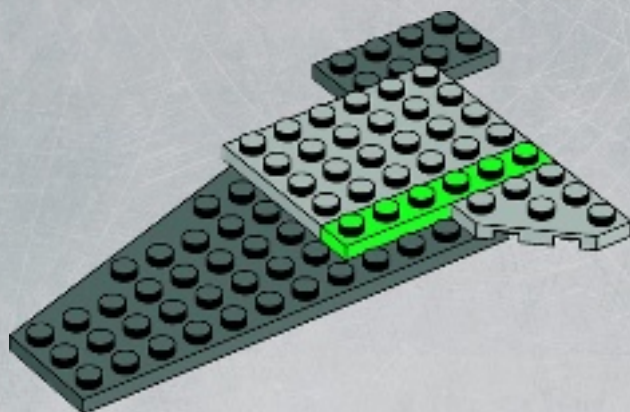

4

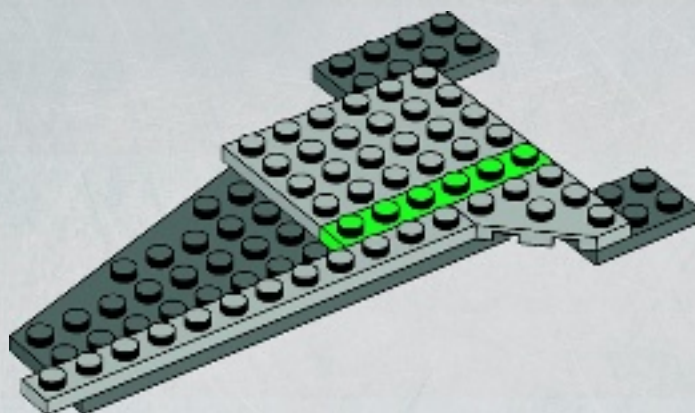

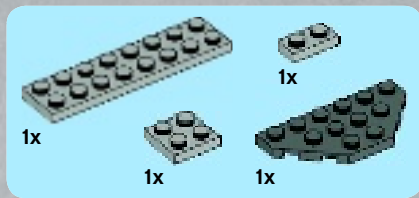

5

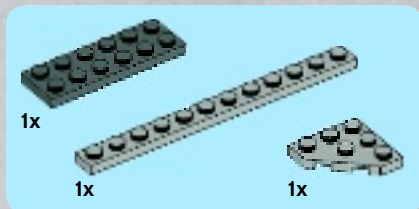
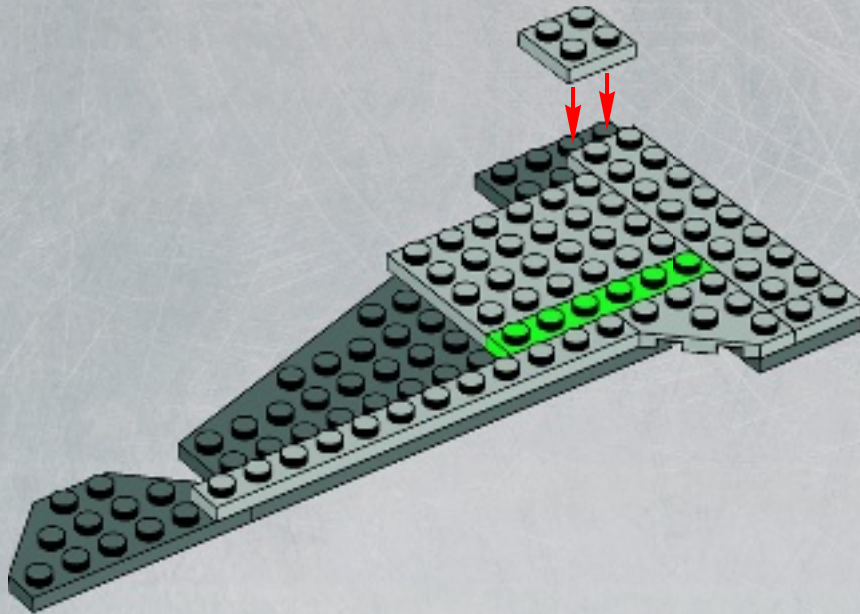

6

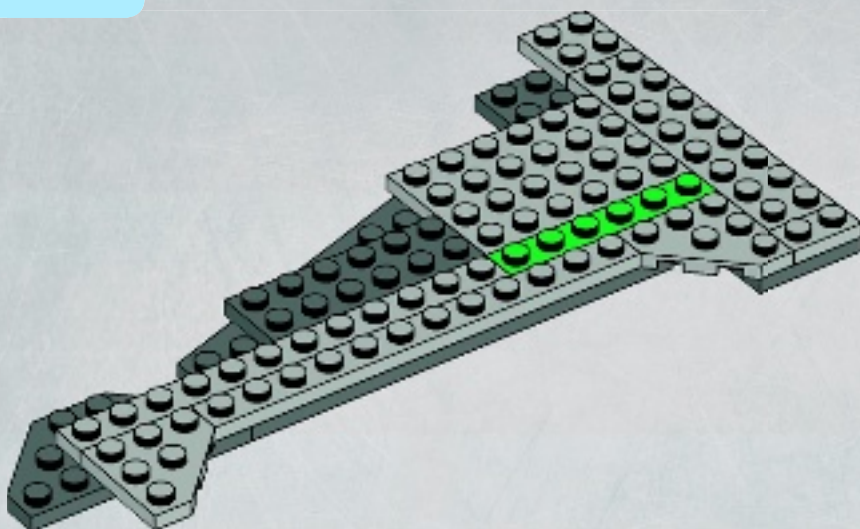

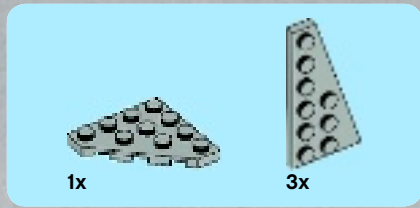

7

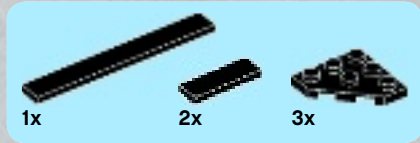
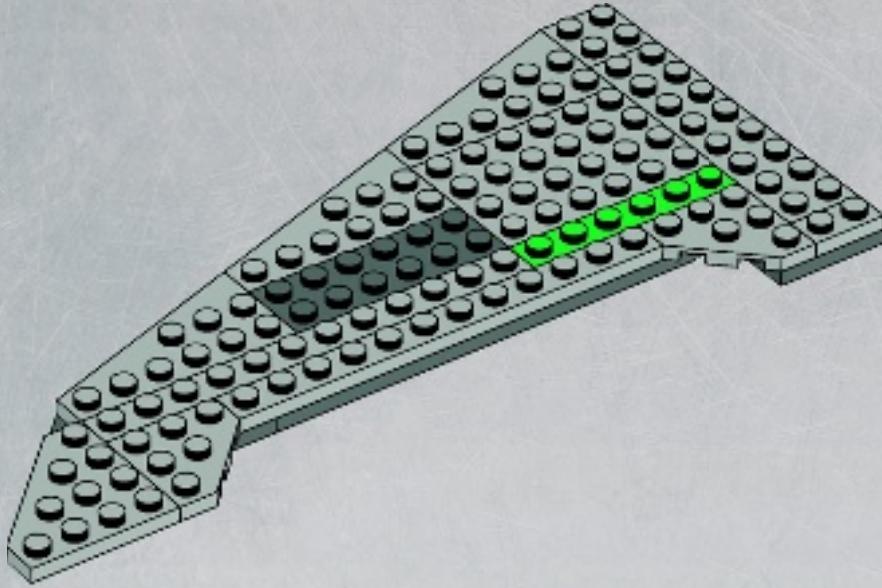

8

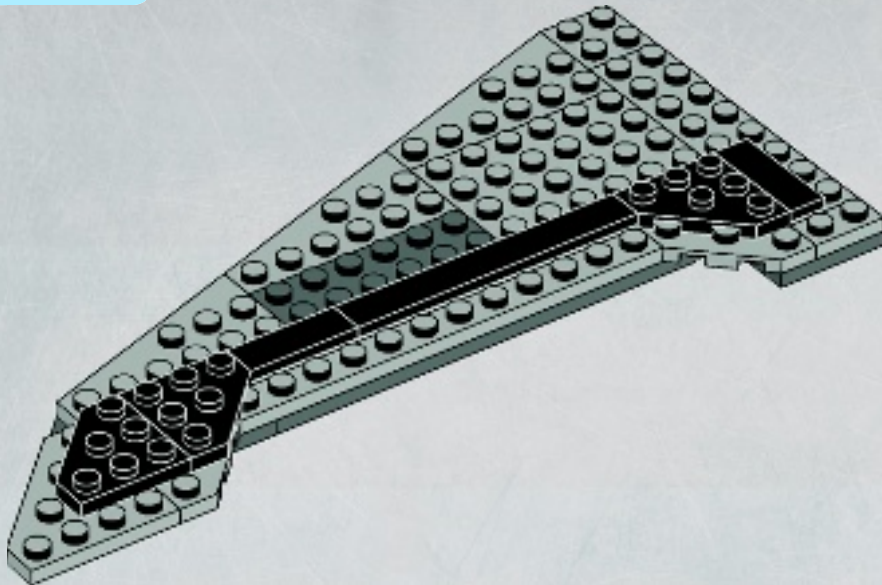

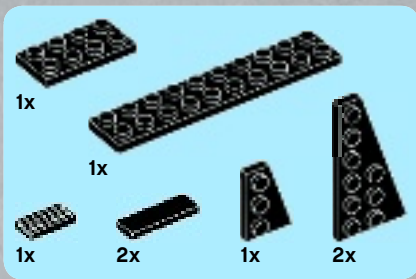

9

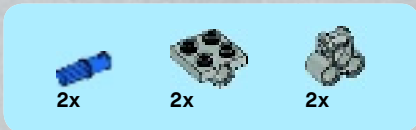
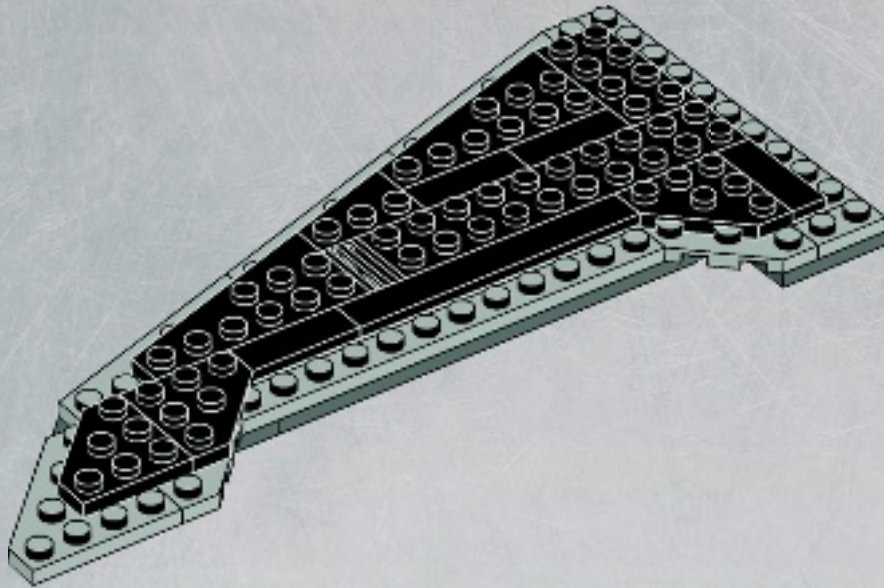

10

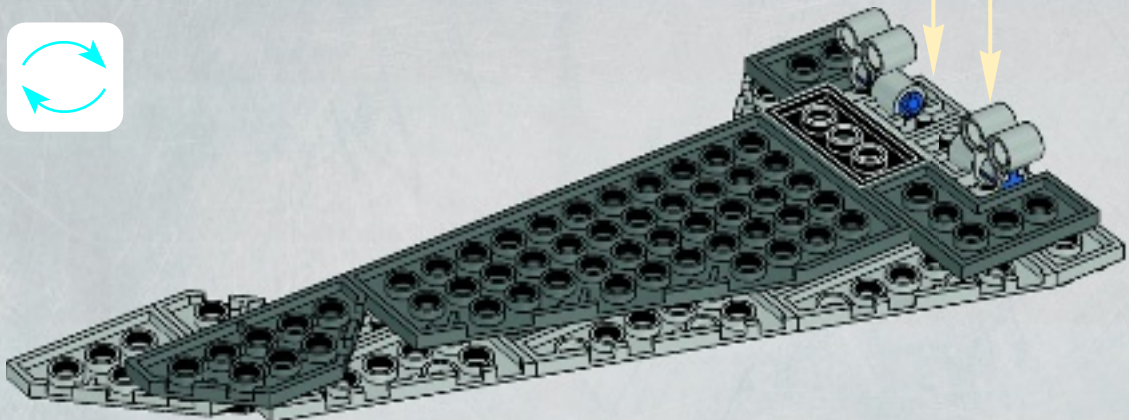
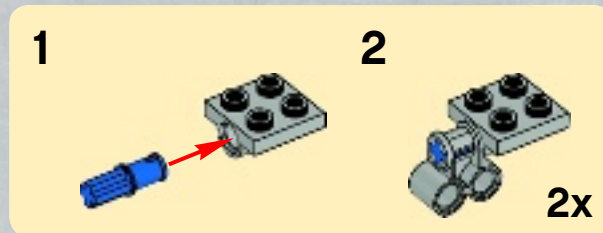



# 11

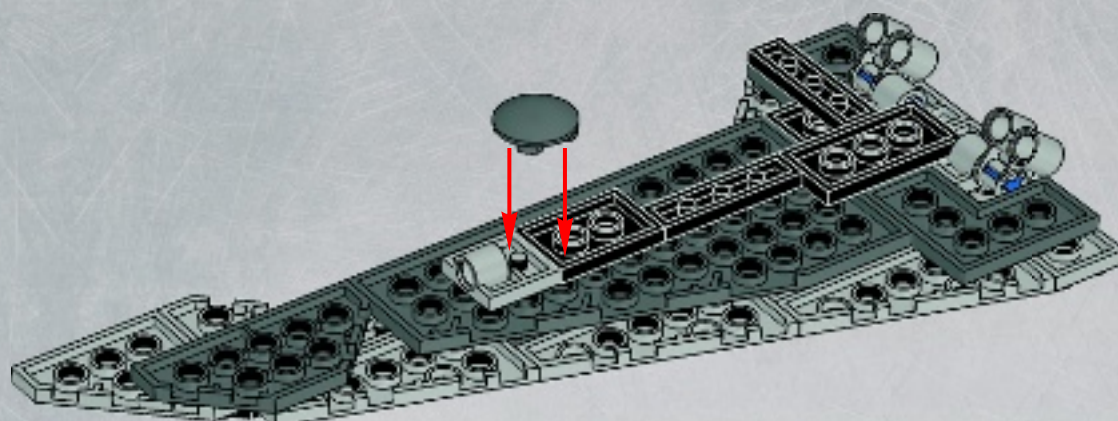

# 12

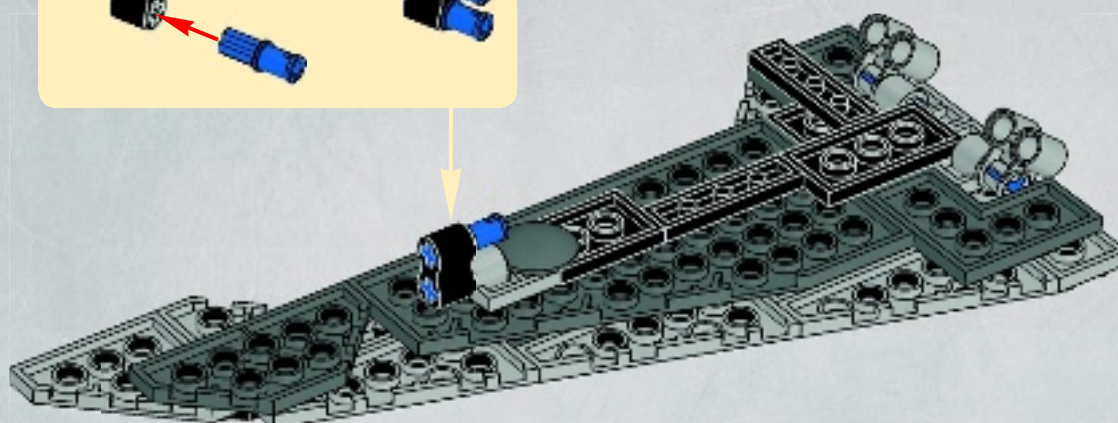
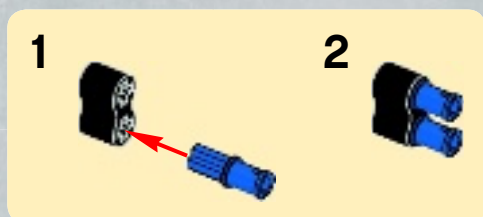

15

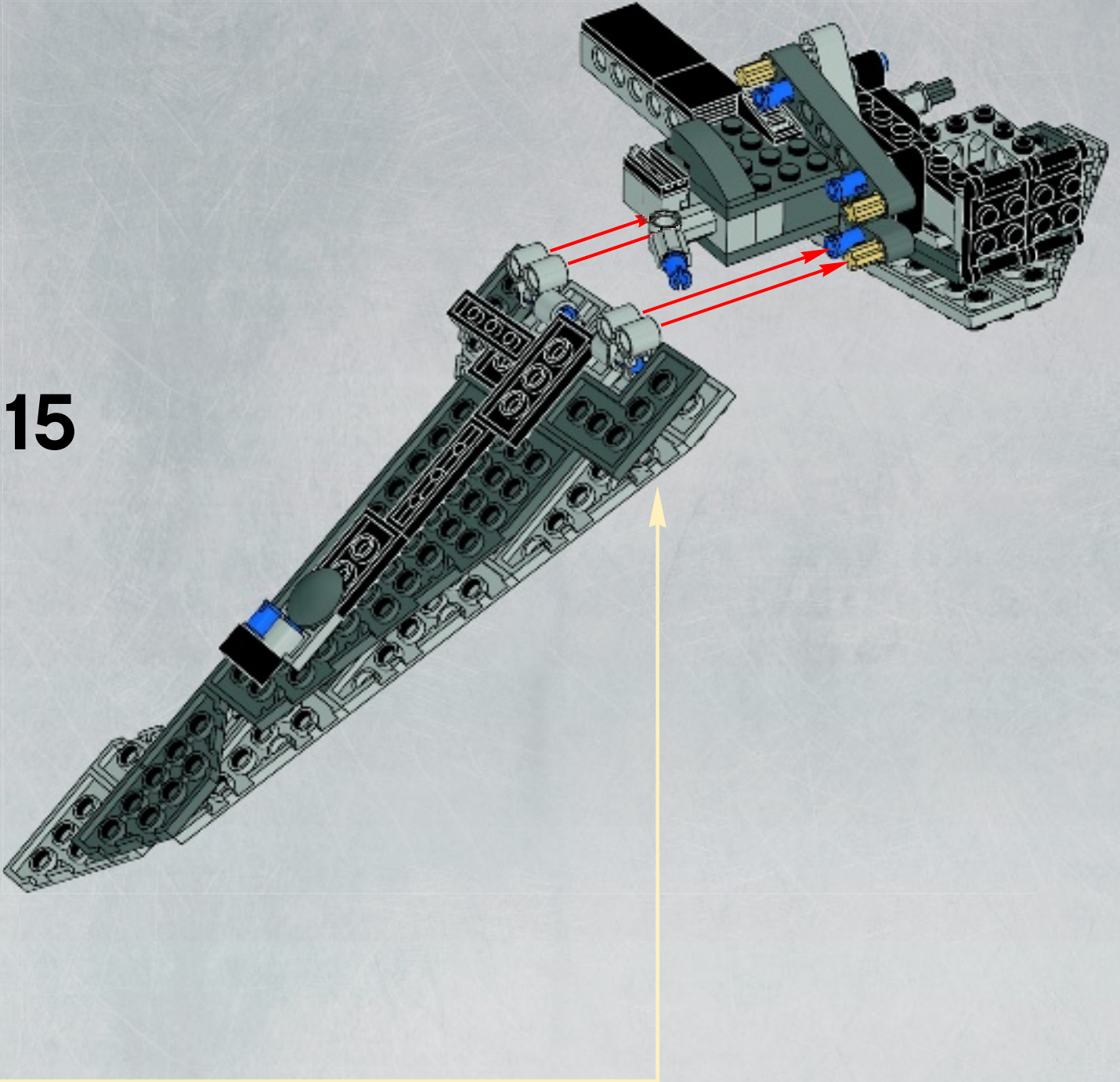

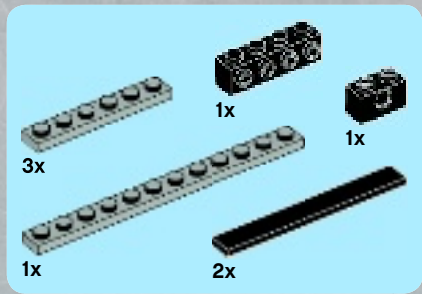
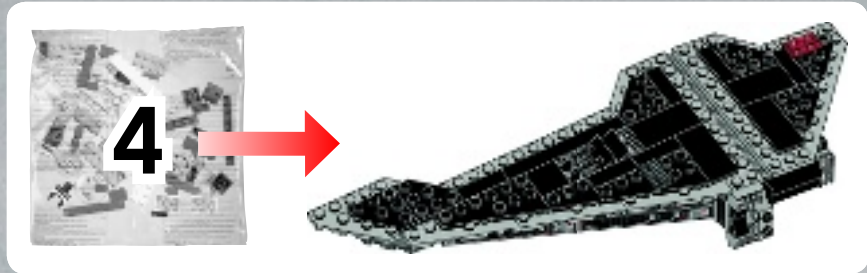

# 16

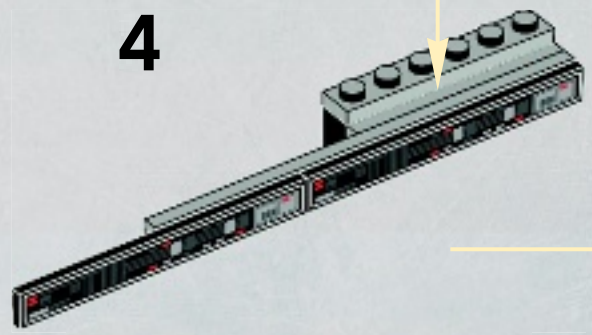
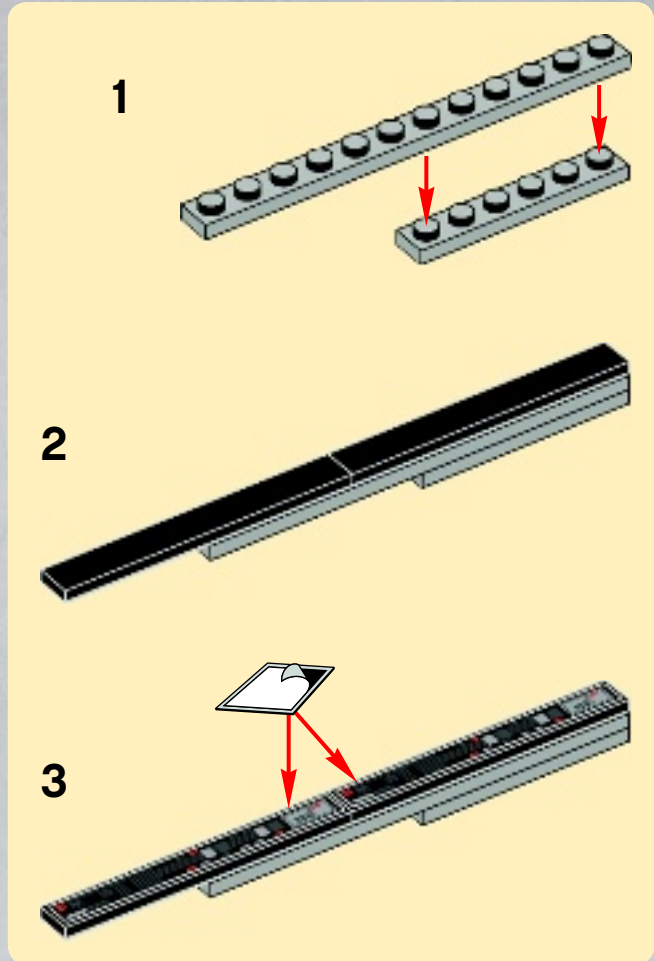
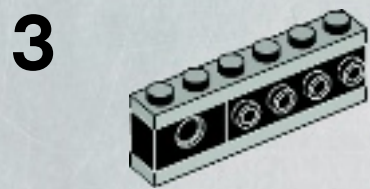
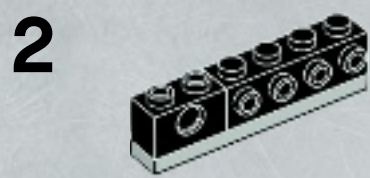
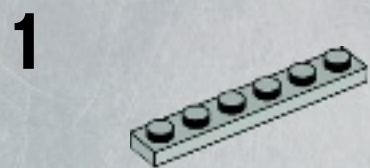



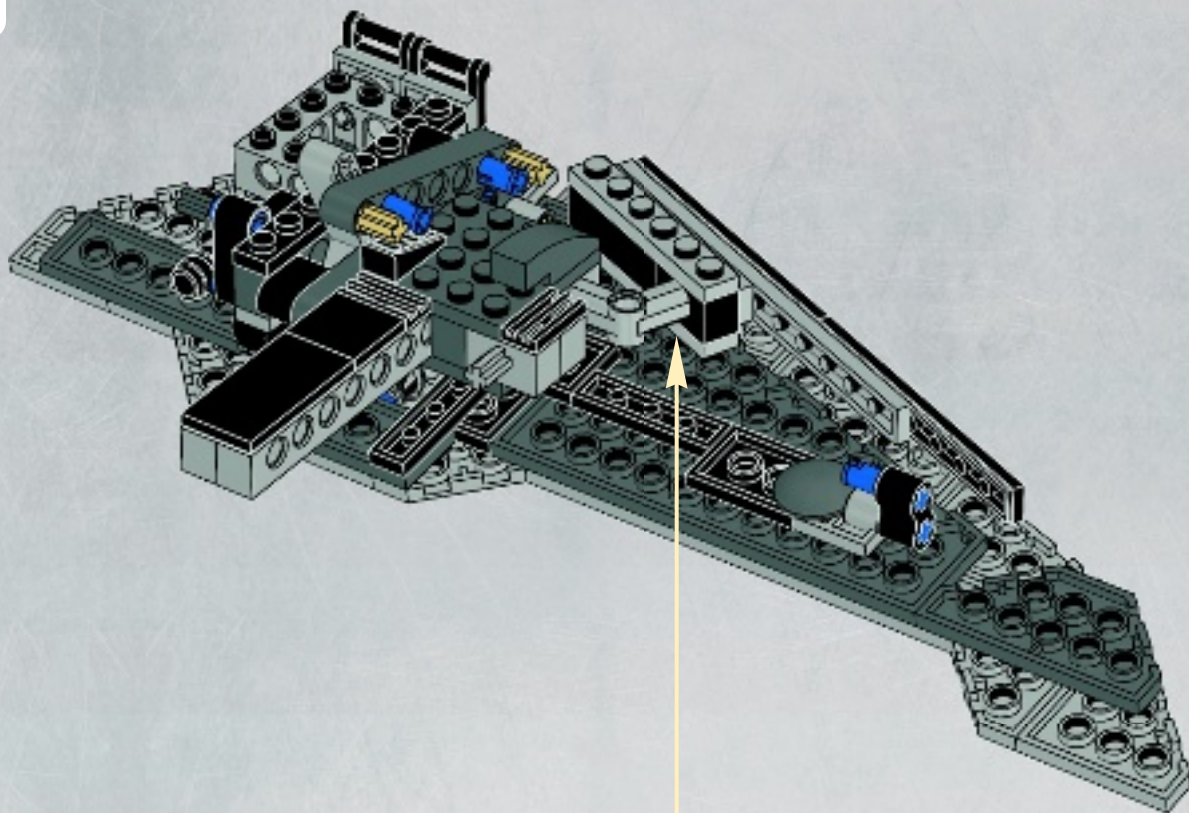

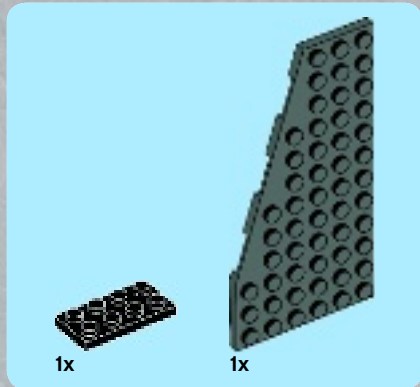
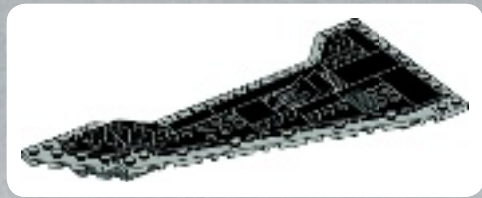

1

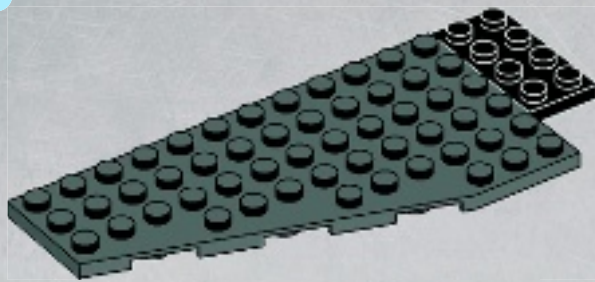

2

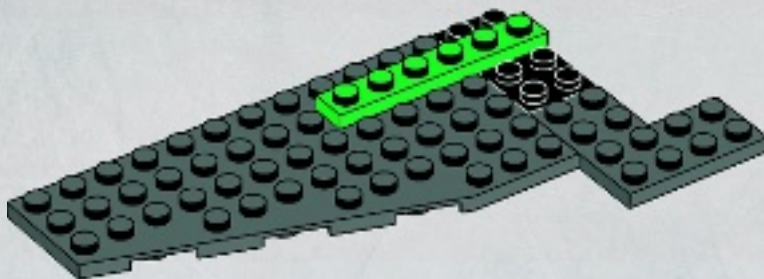

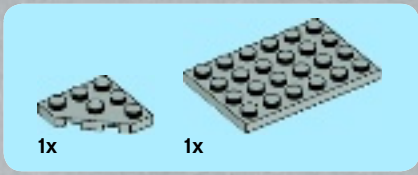

3

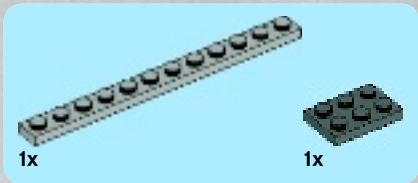
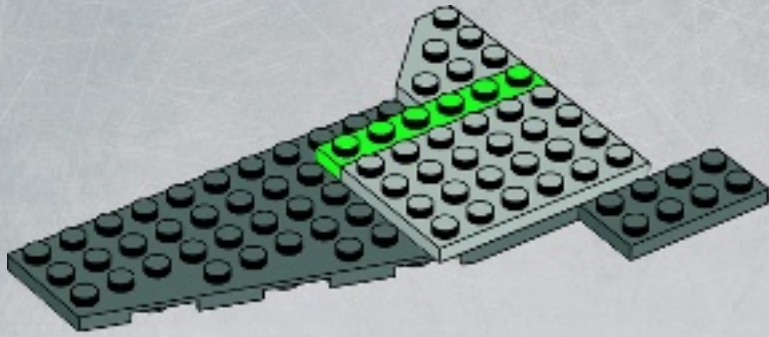

4

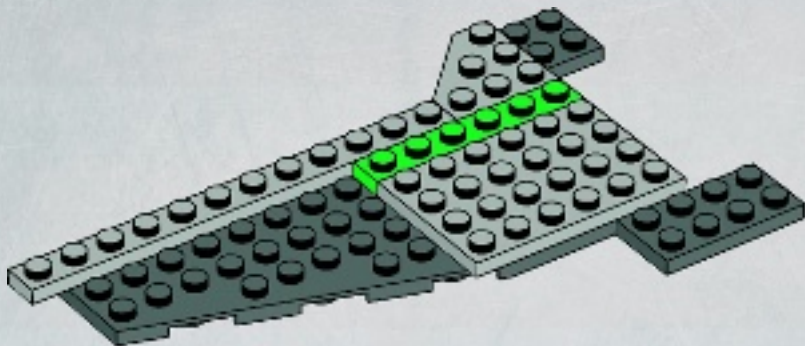

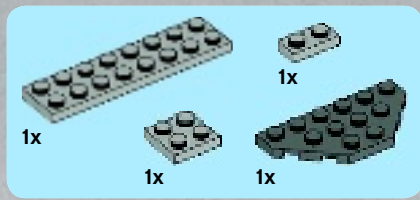

5

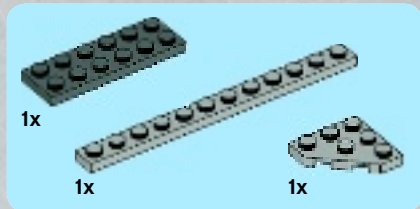
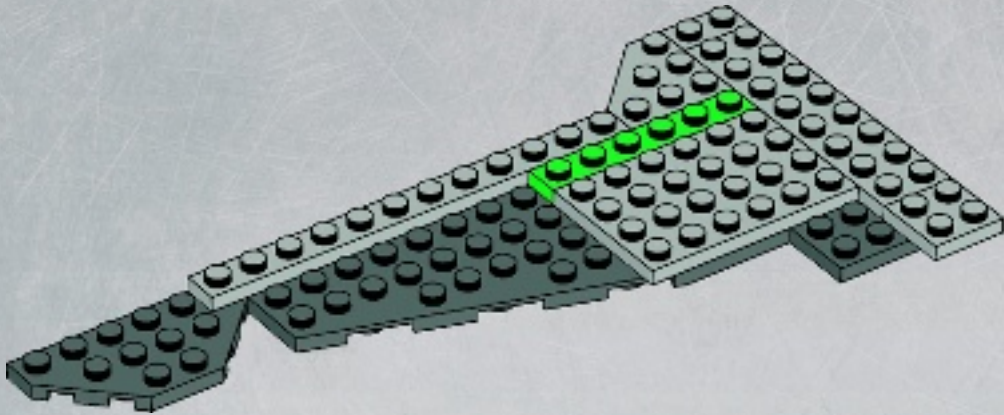

6

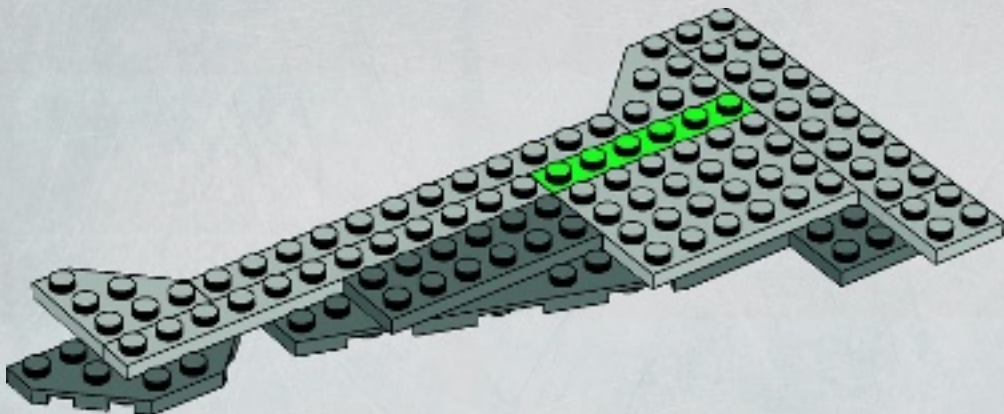

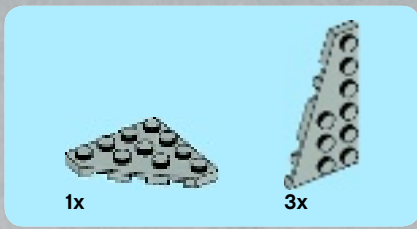

7

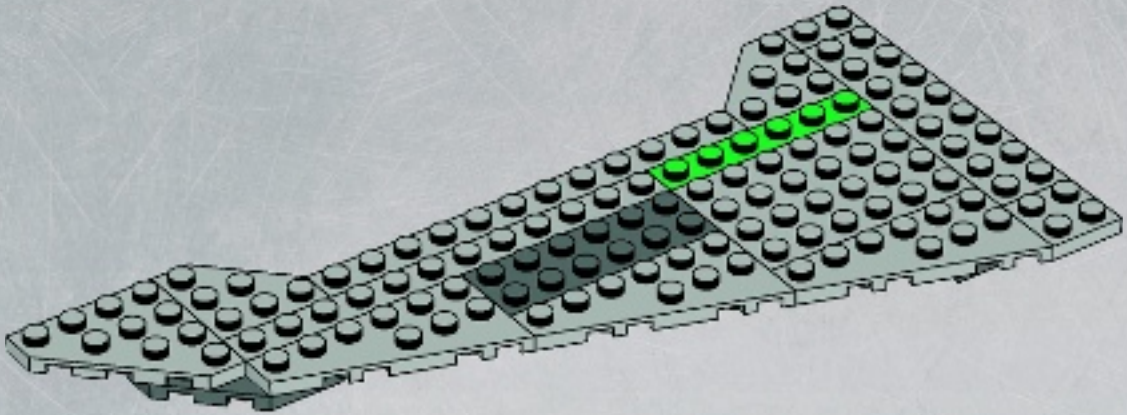

8

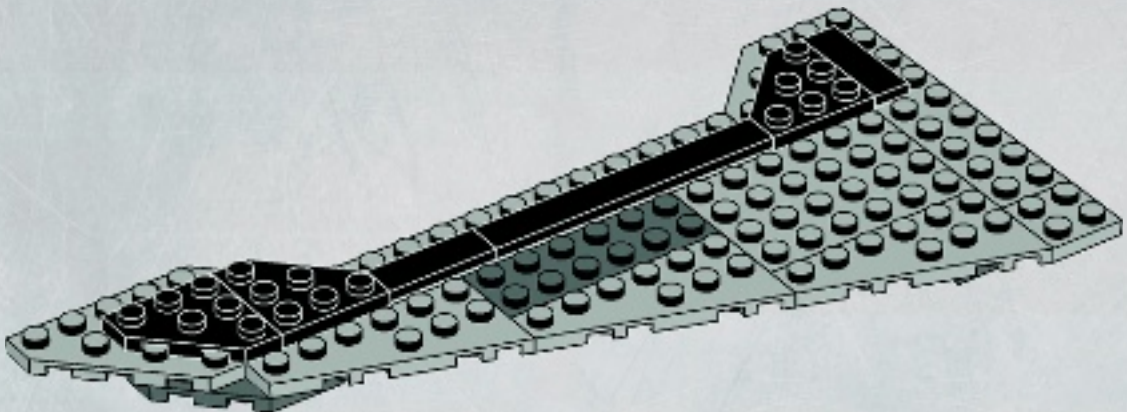

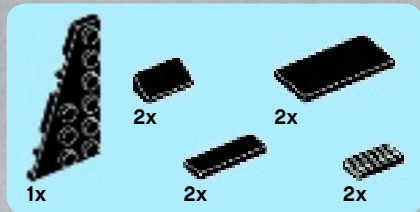

9

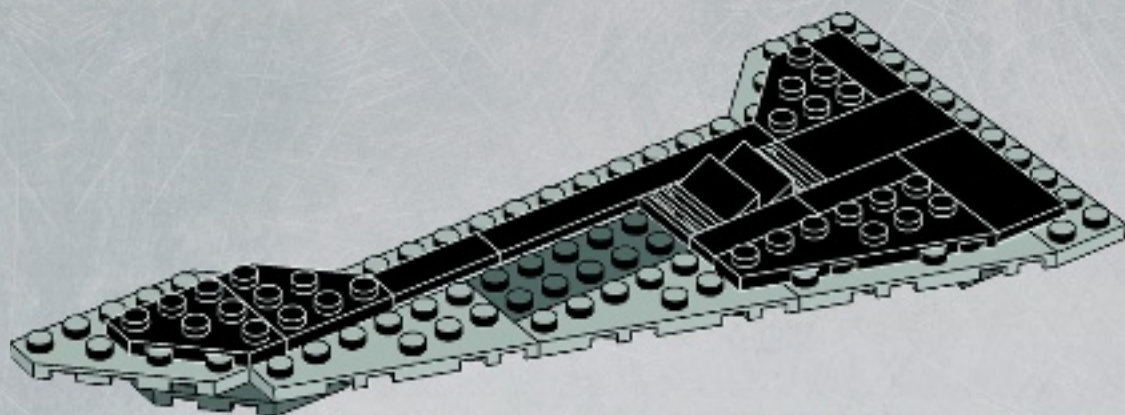

10

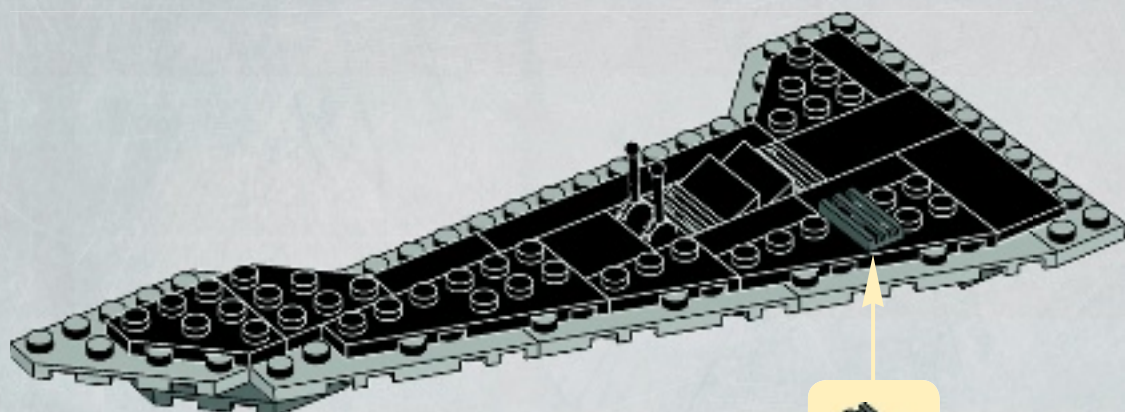



11

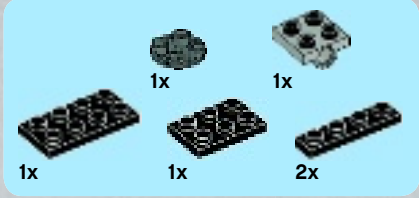
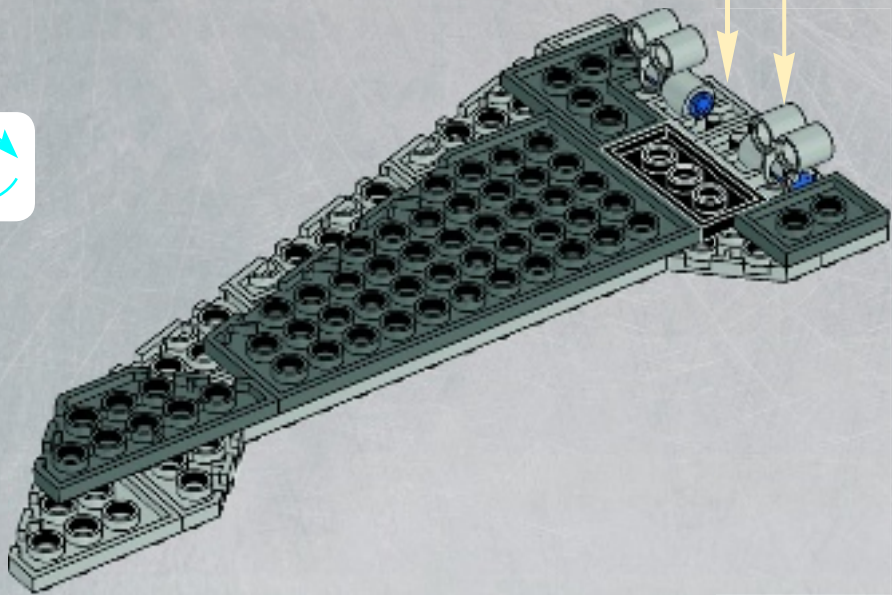
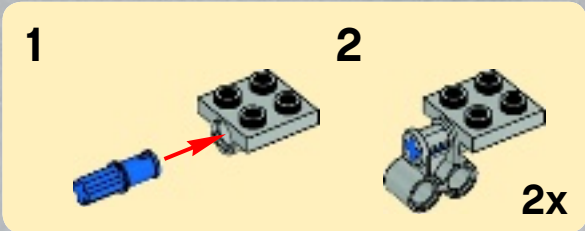

12

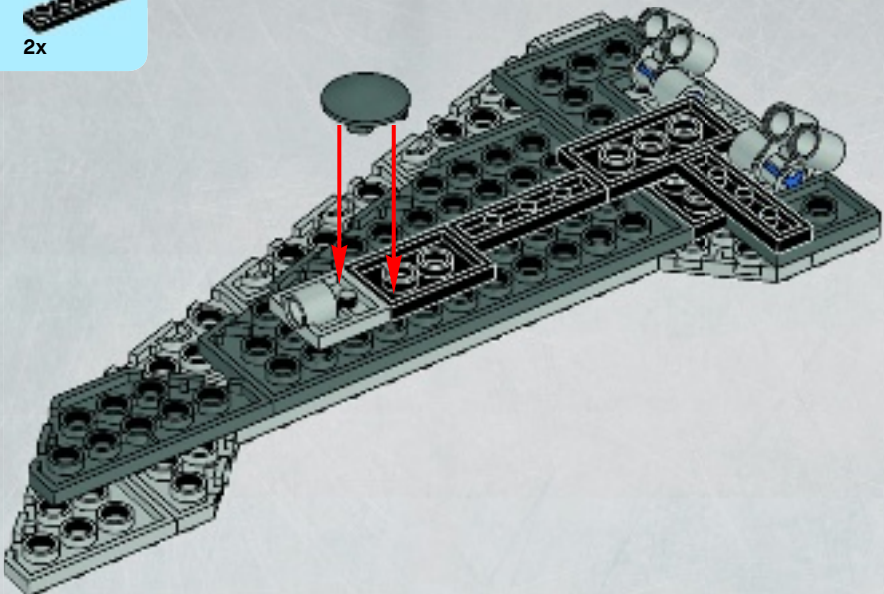

17

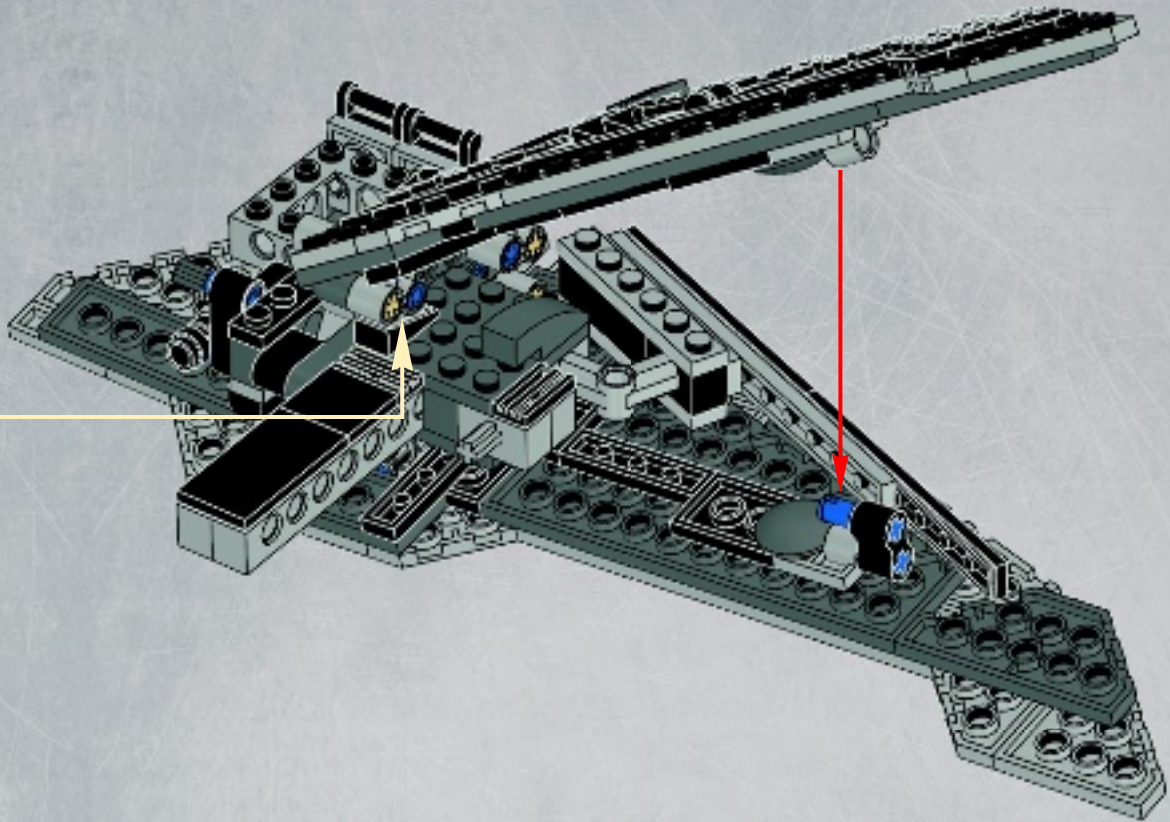

18

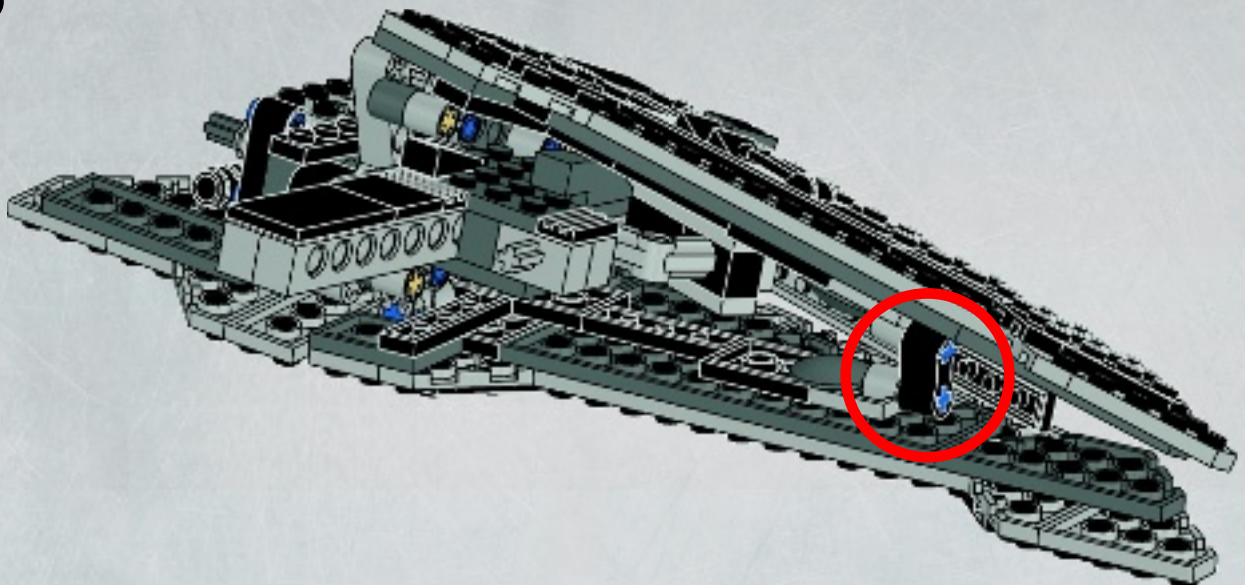







# 20

- 1
- 2
- 3

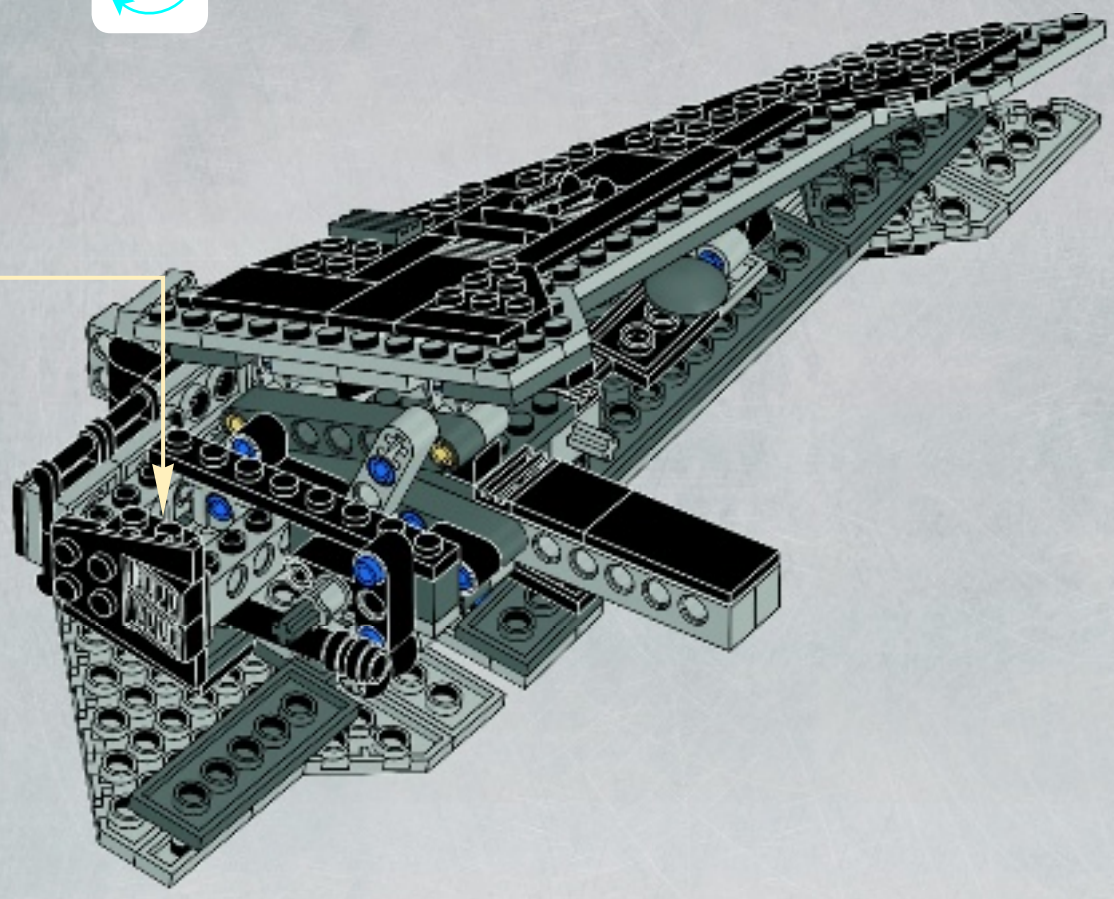

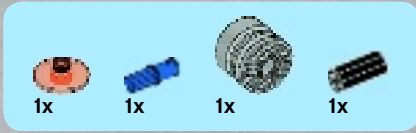

# 21

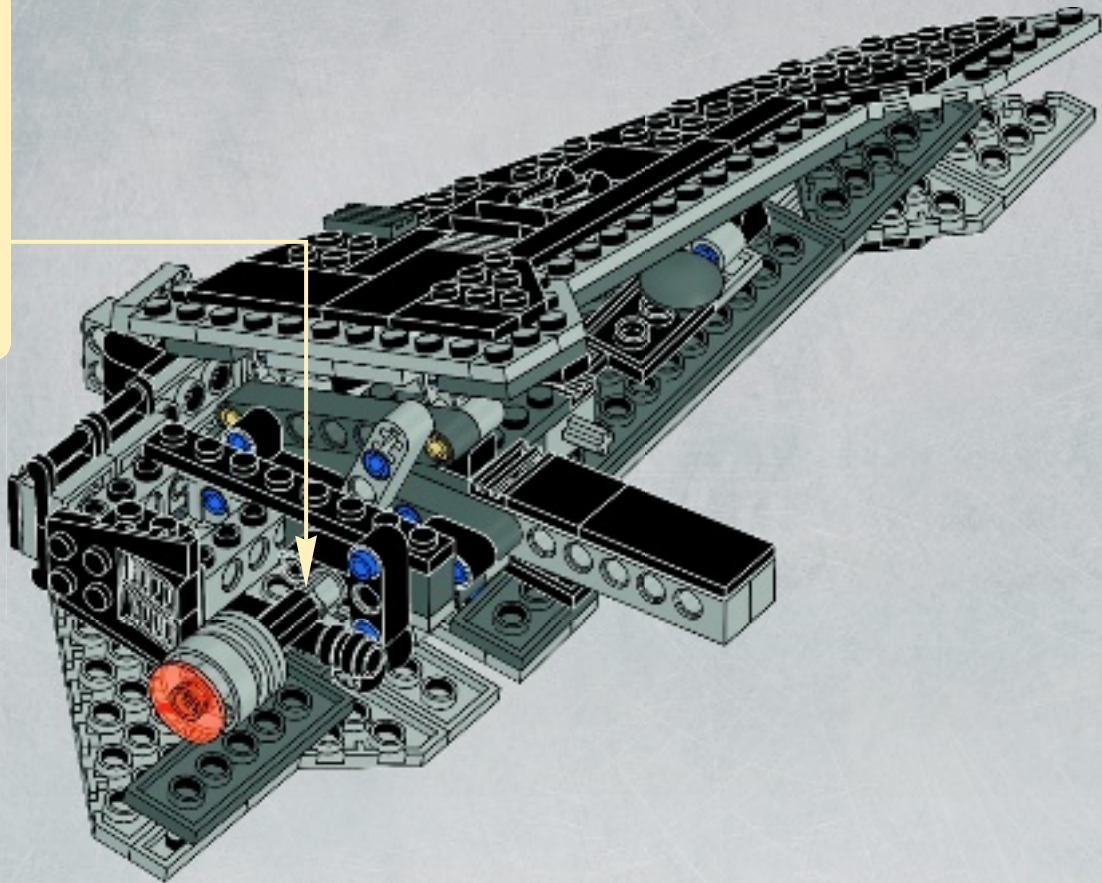
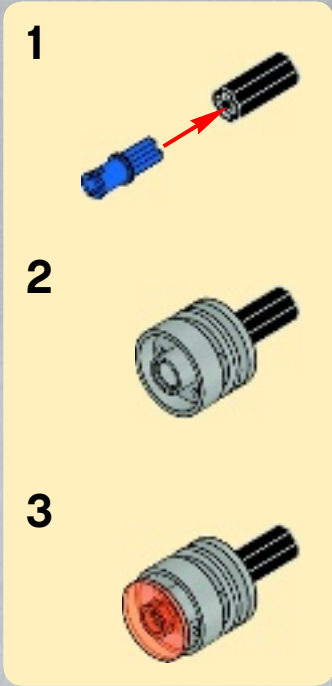

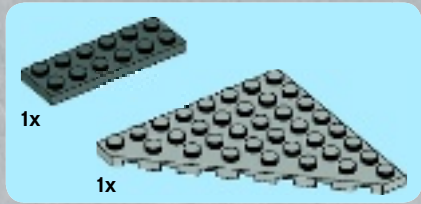

1

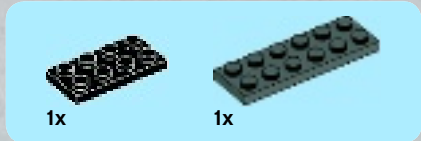
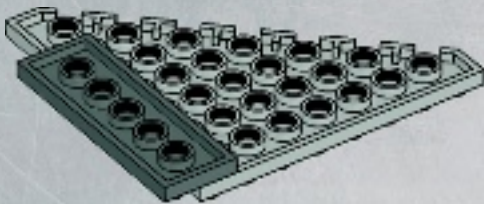

2

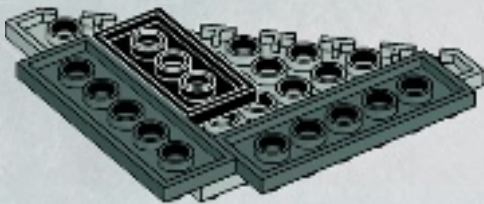

3

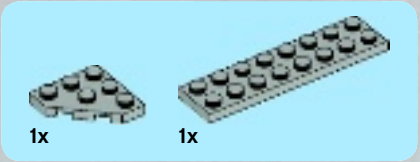
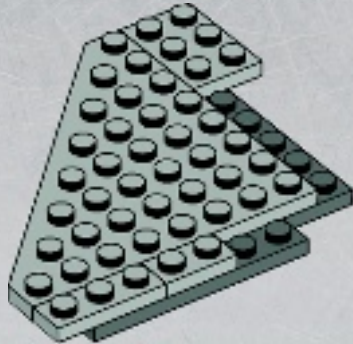

4

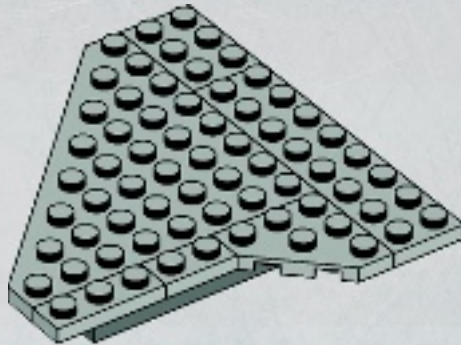



2x



1x

5

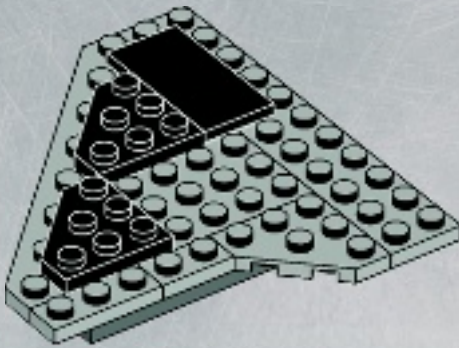

1x

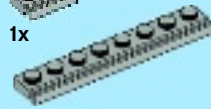

1x



1x

7

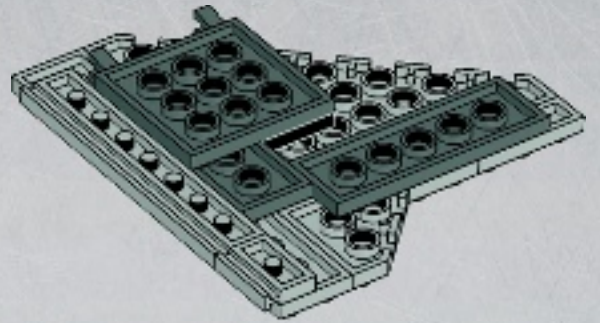

1x



1x



2x



1x

6

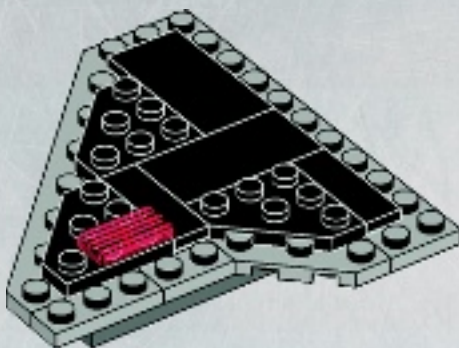

1x



1x

8

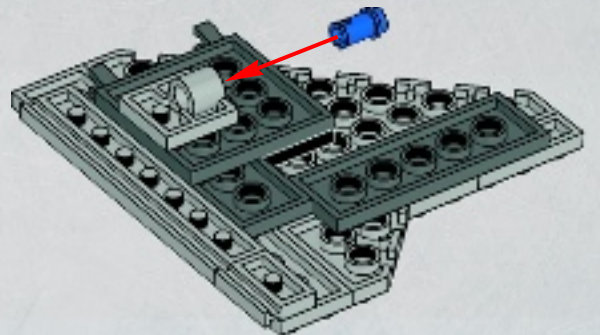

# 22

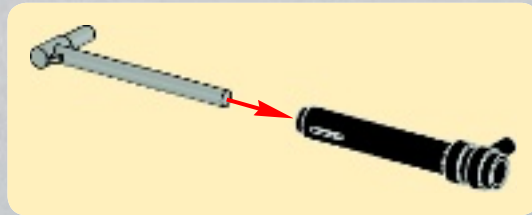
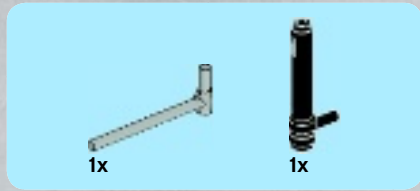
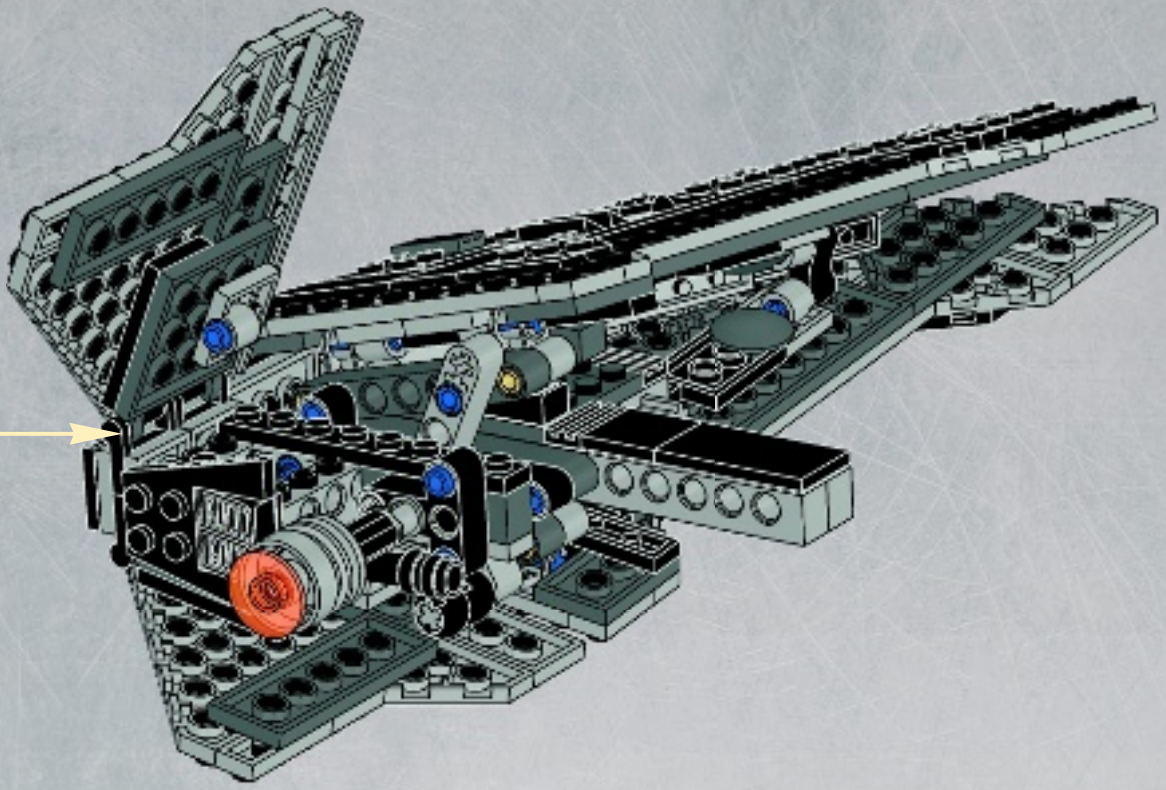

# 23

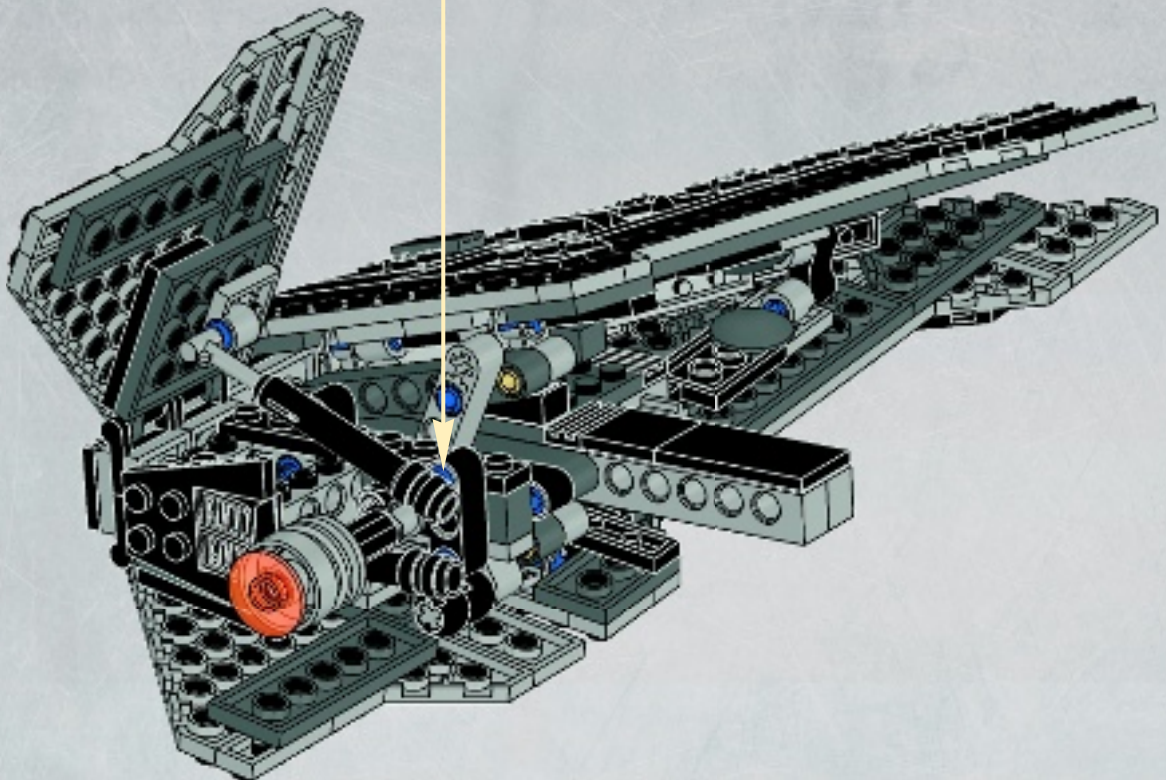

24

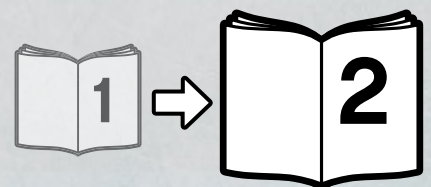
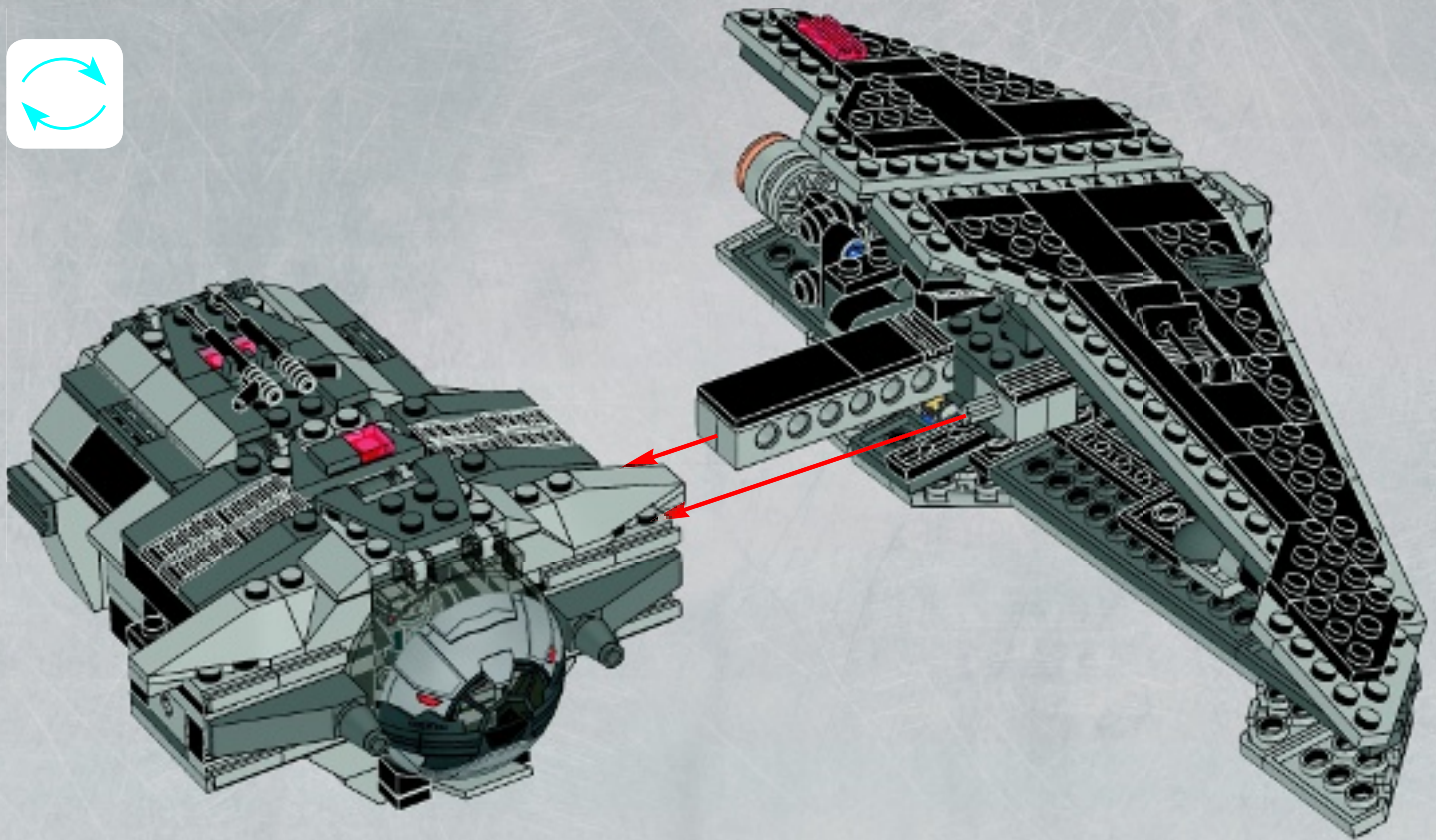



# WIN!

Go to [www.LEGOsurvey.com/product](http://www.LEGOsurvey.com/product) to fill out a survey for a chance to win a cool LEGO® Product. No purchase necessary. Open to all residents where not prohibited.



[www.LEGO.com](http://www.LEGO.com)



## [www.LEGOsurvey.com/product](http://www.LEGOsurvey.com/product)

### GEWINNE!

Nimm an der Umfrage auf [www.LEGOsurvey.com/product](http://www.LEGOsurvey.com/product) teil und hab die Chance ein cooles LEGO® Produkt zu gewinnen! Die Teilnahme am Gewinnspiel führt zu keinerlei Kaufverpflichtungen. Teilnahme in allen nicht ausgeschlossenen Ländern möglich.

### WIN!

Ga naar [www.LEGOsurvey.com/product](http://www.LEGOsurvey.com/product), vul een enquêteformulier in en maak kans op een cool LEGO® product. Geen aankoopverplichting. Iedereen mag deelnemen, uitgezonderd ingezetenden van landen waar een enquêteverbod geldt.

### GAGNE!

Visite [www.LEGOsurvey.com/product](http://www.LEGOsurvey.com/product) pour répondre à un questionnaire et avoir une chance de gagner un produit LEGO® très cool ! Aucune obligation d'achat. Ouvert à tous les résidents des pays autorisés.

### 当てよう!

[www.LEGOsurvey.com/product](http://www.LEGOsurvey.com/product) にアクセスして、アンケートにご記入ください。当選者にはレゴ製品を差し上げます。お買い上げの必要はありません。禁止されていない限り、すべての皆様にご利用いただけます。